

**'A fantastic practical guide to character animation.'**

Andrew Lindsay, Senior Animator, Lionhead Studios



CD-ROM  
INCLUDED  
FOR MAC



# Character Animation

2D skills for better 3D

Steve Roberts

Second Edition



## Character Animation: 2D Skills for Better 3D

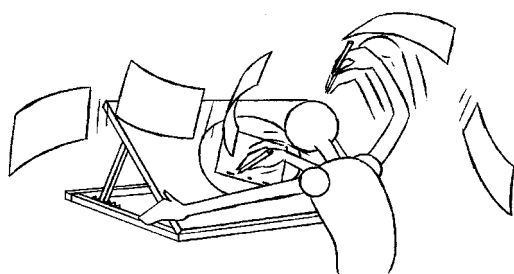

*This page intentionally left blank*

# Character Animation: 2D Skills for Better 3D

Second edition

**Steve Roberts**

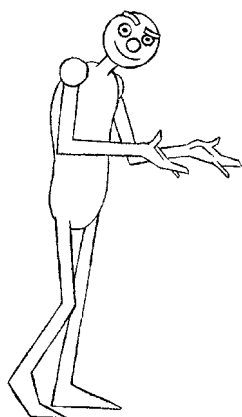

AMSTERDAM • BOSTON • HEIDELBERG • LONDON • NEW YORK • OXFORD  
PARIS • SAN DIEGO • SAN FRANCISCO • SINGAPORE • SYDNEY • TOKYO

Focal Press is an imprint of Elsevier



This eBook does not include ancillary media that was packaged with the printed version of the book.

Focal Press is an imprint of Elsevier  
Linacre House, Jordan Hill, Oxford OX2 8DP, UK  
30 Corporate Drive, Suite 400, Burlington, MA 01803, USA

First published 2004  
Second edition 2007

Copyright © 2007, Steve Roberts. Published by Elsevier Ltd. All rights reserved

The right of Steve Roberts to be identified as the author of this work has been asserted in accordance with the Copyright, Designs and Patents Act 1988

No part of this publication may be reproduced, stored in a retrieval system or transmitted in any form or by any means electronic, mechanical, photocopying, recording or otherwise without the prior written permission of the publisher

Permissions may be sought directly from Elsevier's Science & Technology Rights Department in Oxford, UK: phone (+44) (0) 1865 843830; fax (+44) (0) 1865 853333; e-mail: [permissions@elsevier.com](mailto:permissions@elsevier.com). Alternatively you can submit your request online by visiting the Elsevier web site at <http://elsevier.com/locate/permissions>, and selecting *Obtaining permission to use Elsevier material*

#### Notice

No responsibility is assumed by the publisher for any injury and/or damage to persons or property as a matter of products liability, negligence or otherwise, or from any use or operation of any methods, products, instructions or ideas contained in the material herein.

#### **British Library Cataloguing in Publication Data**

Roberts, Steve, 1941–

Character animation : 2D skills for better 3D. – 2nd ed.

1. Animation (Cinematography) – Handbooks, manuals, etc.
2. Figure drawing – Handbooks, manuals, etc.
3. Computer animation – Handbooks, manuals, etc.

I. Title II. Roberts, Steve, 1941–. Character animation in 3D  
778.5'347

**Library of Congress Number:** 2007921137

ISBN-13: 978-0-240-52054-4

ISBN-10: 0-240-52054-8

For information on all Focal Press publications  
visit our website at: [www.focalpress.com](http://www.focalpress.com)

Typeset by Charon Tec Ltd (A Macmillan Company), Chennai, India  
[www.charontec.com](http://www.charontec.com)

Printed and bound in Great Britain

07 08 09 10 11 10 9 8 7 6 5 4 3 2 1

Working together to grow  
libraries in developing countries

[www.elsevier.com](http://www.elsevier.com) | [www.bookaid.org](http://www.bookaid.org) | [www.sabre.org](http://www.sabre.org)

ELSEVIER

BOOK AID  
International

Sabre Foundation

# contents

|  |           |
|--|-----------|
| foreword   | xi        |
| preface  | xiii      |
| acknowledgements                                     | xv        |
| chapter 1  |           |
| <b>introduction to 2D-animation working practice</b> | <b>1</b>  |
| how animation works the basics                       | 2         |
| frames per second                                    | 2         |
| what you need for your studio                        | 3         |
| animation paper                                      | 3         |
| peg bar  | 3         |
| light box  | 4         |
| x-sheets   | 4         |
| line tester  | 9         |
| pencils  | 11        |
| let's get animating                                  | 11        |
| key to key animation                                 | 11        |
| animating straight ahead                             | 13        |
| flipping, flicking and rolling                       | 13        |
| flipping   | 13        |
| flicking   | 14        |
| rolling  | 17        |
| how to use a line tester to help your animation      | 18        |
| how this book works                                  | 19        |
| chapter 2  |           |
| <b>matter and the animation of inanimate objects</b> | <b>28</b> |
| inanimate objects                                    | 29        |
| weight   | 29        |
| environment  | 30        |
| solidity   | 30        |
| force  | 30        |
| construction   | 30        |
| how to animate inanimate objects                     | 30        |
| the animation of solids                              | 31        |
| a bowling ball                                       | 31        |

|                           |    |
|---------------------------|----|
| a soccer ball             | 32 |
| a balloon                 | 33 |
| a water-filled balloon    | 33 |
| the animation of liquids  | 35 |
| a drip                    | 35 |
| a splash                  | 36 |
| object falling into water | 36 |

## chapter 3

### **the construction of a simple character, its articulation and balance** **48**

|  |    |
|--|----|
| basic human anatomy                        | 49 |
| the spine                                  | 50 |
| the rib cage                               | 50 |
| the pelvic girdle                          | 51 |
| the skull                                  | 51 |
| the shoulders                              | 51 |
| joints                                     | 52 |
| plane joints                               | 52 |
| pivot joints                               | 53 |
| hinge joints                               | 53 |
| ball-and-socket joints                     | 53 |
| saddle joints                              | 53 |
| condyloid joints                           | 54 |
| moving in arcs                             | 54 |
| how to design a basic human character      | 55 |
| complexity                                 | 56 |
| the graphic nature of characters           | 56 |
| strong silhouettes                         | 57 |
| weight and balance                         | 57 |
| how to design a 3D character               | 59 |
| planning a scene                           | 61 |
| animating your characters                  | 62 |
| how to build and rig a simple 3D character | 80 |
| skin and bones                             | 81 |
| child of the joint                         | 81 |
| first get your body parts                  | 83 |
| putting bones in your man                  | 83 |
| setting up eye controls                    | 85 |
| setting up the legs                        | 85 |

## chapter 4

### **timing, anticipation, overshoot, follow-through and overlapping action with an animated character** **87**

|              |    |
|--------------|----|
| timing       | 88 |
| anticipation | 90 |

---

|  |            |
|--|------------|
| how much anticipation                      | 91         |
| force                                      | 92         |
| acting and anticipation                    | 93         |
| double takes!                              | 93         |
| speed and surprise                         | 94         |
| anticipation during a move                 | 94         |
| varying the amount of anticipation         | 95         |
| other ways of using anticipation           | 96         |
| follow-through                             | 96         |
| follow-through of inanimate objects        | 97         |
| follow-through of animate (living) objects | 98         |
| overlapping action or overshoot            | 101        |
| vibration                                  | 103        |
| <br>                                       |            |
| chapter 5                                  |            |
| <b>human walks and runs</b>                | <b>113</b> |
| walk cycles!                               | 114        |
| walking                                    | 115        |
| pace                                       | 115        |
| walking mechanics                          | 116        |
| the four basic positions of a walk         | 116        |
| the stride positions                       | 116        |
| the cross over positions                   | 117        |
| shoulder movement                          | 118        |
| arm movement                               | 120        |
| up and down movement of the body           | 120        |
| walk cycles displaying different moods     | 121        |
| external influences                        | 128        |
| two people walking together                | 129        |
| running                                    | 129        |
| <br>                                       |            |
| chapter 6                                  |            |
| <b>animal walks and runs</b>               | <b>136</b> |
| the four types of animal locomotion        | 137        |
| construction of an animal                  | 137        |
| pantomime horse                            | 137        |
| cartoon four-legged walks                  | 139        |
| correct four-legged animal construction    | 140        |
| animal leg and foot construction           | 140        |
| animals with paws                          | 140        |
| a dog walk                                 | 141        |
| a cat walk                                 | 145        |
| animals with cloven feet                   | 146        |
| animals with hooves                        | 146        |
| flat feet                                  | 147        |
| animal runs                                | 148        |



---

|  |            |
|--|------------|
| trotting                                   | 148        |
| cantering                                  | 149        |
| galloping                                  | 150        |
| transverse or rotary gallops and canters   | 151        |
| <br>chapter 7                              |            |
| <b>animation of fish and snakes</b>        | <b>158</b> |
| fish                                       | 158        |
| how they swim                              | 159        |
| drag                                       | 159        |
| two swimming types of fish                 | 160        |
| schooling (shoaling)                       | 160        |
| swimming mammals and flatfish              | 161        |
| rays                                       | 161        |
| fins                                       | 161        |
| snakes                                     | 162        |
| basic movement                             | 162        |
| concertina movement                        | 163        |
| crotaline (sidewinder) movement            | 163        |
| <br>chapter 8                              |            |
| <b>animation of birds</b>                  | <b>170</b> |
| flying                                     | 170        |
| wings – insects and humming bird           | 172        |
| <br>chapter 9                              |            |
| <b>animation of acting – body language</b> | <b>178</b> |
| acting                                     | 179        |
| method acting                              | 180        |
| theatrical acting                          | 180        |
| consequence                                | 180        |
| emotions                                   | 181        |
| introduction to Laban Movement theory      | 182        |
| kinesphere                                 | 182        |
| space, time, weight and flow continuums    | 183        |
| eight basic efforts                        | 183        |
| pressing                                   | 183        |
| flicking                                   | 183        |
| wringing                                   | 184        |
| dabbing                                    | 184        |
| slashing                                   | 184        |
| gliding                                    | 184        |
| thrusting                                  | 184        |
| floating                                   | 184        |

---

|   |            |
|---|------------|
| general body language                           | 185        |
| basic body postures                             | 186        |
| open body postures                              | 186        |
| closed body postures                            | 187        |
| forward body postures                           | 187        |
| back body postures                              | 187        |
| responsive                                      | 187        |
| reflective                                      | 189        |
| fugitive  | 190        |
| combative                                       | 191        |
| palm, hand, arm and leg gestures                | 192        |
| palm gestures                                   | 192        |
| hand gestures                                   | 192        |
| arm crossing                                    | 193        |
| leg crossing                                    | 194        |
| acting out a scene in animation                 | 195        |
| the use of video footage to help your animation | 198        |
| the seven questions of character                | 199        |
| the different sorts of animation acting         | 200        |
| animated radio                                  | 200        |
| pose-to-pose animation acting                   | 201        |
| full animation acting                           | 201        |
| mime  | 202        |
| analysis of a character                         | 203        |
| building a more sophisticated character         | 208        |
| <br>  |            |
| chapter 10                                      |            |
| <b>animation of acting – facial expressions</b> | <b>214</b> |
| emotions  | 215        |
| the eyes  | 217        |
| facial expressions                              | 219        |
| happiness                                       | 219        |
| a smile   | 219        |
| sadness   | 220        |
| surprise  | 221        |
| fear  | 222        |
| anger   | 222        |
| disgust and contempt                            | 223        |
| interest  | 223        |
| pain and distress                               | 224        |
| combination of facial expressions               | 225        |
| head angle                                      | 226        |
| hand-to-face gestures                           | 226        |
| evaluation                                      | 227        |
| deceit  | 227        |
| stress  | 228        |

|  |            |
|--|------------|
| extreme close-ups  | 228        |
| how to animate a piece of facial acting                        | 228        |
| how to add a simple mouth and eyebrows to your basic           |            |
| 3D character   | 238        |
| the eyebrows   | 239        |
| the mouth  | 239        |
| <br>   |            |
| chapter 11   |            |
| <b>animation of acting – two or more characters</b>            | <b>241</b> |
| two characters on screen together                              | 241        |
| the use of 'beats' to break up a scene                         | 242        |
| objective  | 242        |
| obstacle   | 242        |
| action   | 242        |
| personal space   | 243        |
| mirroring  | 244        |
| how characters look at each other                              | 245        |
| two characters acting with each other while talking            | 246        |
| two characters alternating from one shot to another            | 247        |
| a large group of characters on screen at the same time         | 248        |
| <br>   |            |
| chapter 12   |            |
| <b>lip-sync</b>  | <b>255</b> |
| recording and breaking down a dialogue track                   | 256        |
| how we speak   | 257        |
| acting with dialogue   | 259        |
| quick from pose to pose  | 260        |
| slow from pose to pose   | 260        |
| erratically from pose to pose                                  | 260        |
| mouth shapes   | 261        |
| mouth shut consonants  | 261        |
| the vowels   | 263        |
| the quieter vowels and consonants                              | 264        |
| teeth  | 264        |
| animating the mouth shapes early                               | 265        |
| creating a more sophisticated character's face and expressions | 269        |
| eyebrow movements  | 270        |
| mouth and jaw movements  | 271        |
| cheek movements  | 273        |
| nose movements   | 273        |
| <br>   |            |
| index  | 275        |

# foreword

Animators are fortunate, not for them the limitations of the theatrical stage or the many hazards of a live action film location shoot! Their only limitations are their imaginations and the size of their chequebooks. With the cosmos at their disposal plus all the colours and sounds in the universe, animation can be a daunting prospect! Small wonder, some takeup gardening or D.I.Y. Steve Roberts (the first time I saw him was at Farnham's Animation course – he was remaking Snow White and the Seven Dwarfs as a satire) is not easily daunted. He has written and illustrated a remarkable book that actually makes animation easy to understand. Using simple illustrations, he takes the reader through every situation they are likely to come across in their progress towards believable animation. The key to this book is SIMPLICITY. Keep it simple! Keep it simple – parting the red sea is for Cecil. B. De. Mille.

Bob Godfrey,  
Oscar-winning animation director

*This page intentionally left blank*

# preface

This book is the culmination of almost 10 years of teaching drawn animation techniques to 3D computer animators.

You may think, 'why on earth does a 3D computer animator need to learn how to do drawn animation?' The answer to this question is that the basics of animation are all the same and often you can get an idea of the movement far more quickly using pencil and paper. A computer can take a lot of the drudgery out of animating, but you can end up doing a piece of animation without quite understanding how it happened and whether it works or not.

One of the most valuable things I have learnt over the past 25 years of animating is to keep things simple!

The main value of an animation teacher is somebody who can cut to the chase and tell you the fundamental things that you need to know. You can then elaborate on top of this in your own way.

I have kept the examples and the animation exercises in this book as simple as possible, so that you are able to build a firm foundation of skills on which you can develop your animation further.

The form of the book is as follows. In each chapter I will go through the fundamentals of a given topic. Then there will be a drawn animation exercise to complete. Then and only then can an identical animation exercise be attempted using the software package of your choice.

The fundamentals, the drawn animation exercise and an overview of how to do the same exercise in 3D will be in the book. On the CD-ROM at the back of the book there will be specific .pdf files where you can follow how to do these exercises in 3D Studio Max, LightWave, Maya and Softimage XSI. There are also 20 models on the CD-ROM, all fully rigged and ready for you to load onto your computer and to do the exercises.

Although this book is specifically about animation there is also a section of the CD-ROM that shows how to build each of these models in each specific program. Software developers are always improving their products, so for up-to-date models and exercises have a look at [www.characteranimationin3d.com](http://www.characteranimationin3d.com), the website that accompanies this book.

I have been in love with animation since the age of seven when my mother took me to see Disney's *Sleeping Beauty* at the cinema. Compared to the little Murphy black and white television we had at home I found the colours, the huge size of the screen and the wonderful sound almost overwhelming. I still always think of an animated film as something special.

I became obsessed with becoming an animator at the age of 10 when I saw a TV show called *The Do It Yourself Film Animation Show* presented by Bob Godfrey. If there is anybody to thank (or blame) for my being involved with animation it's Bob. It's wonderful to have worked with him and to be regarded by him as a friend. Other great inspirations to me have been Tex Avery and Chuck Jones. My favourite cartoon characters as a kid were Screwy Squirrel and Droopy (both Tex Avery creations) closely followed by Daffy Duck and Bugs Bunny (generally the incarnations of these characters in Chuck Jones's films).

The list of animators I'm in awe of is almost endless. John Lasseter, Joanna Quinn, Hayao Miyazaki, Nick Park, Brad Bird, Jan Svankmajer, ... I could go on and on.

Hopefully this book will inspire you.

# acknowledgements

Of course this book would not have been possible without the following people:

Dee Honeybun for going through my unintelligible notes and turning them into something worth reading.

Marie Hooper for commissioning the book in the first place and putting up with every missed deadline.

Christina Donaldson for all the stupid questions I've asked her and all the things she's had to do to put this book together.

Margaret Denley for putting up with so many different versions of this acknowledgements page and all the little corrections.

Paul Temme, Georgia Kennedy and Lisa Jones for commissioning and overseeing the second edition of the book.

Claudia Lester for being my 'best man' and persuading me that function curves are my friends.

Kevin Rowe for help with Maya and Acting.

Birgitta Hosea for making time for me.

Bob Godfrey for getting me into animation in the first place – I was bought his book *The Do It Yourself Film Animation Book* at the age of ten.

Paul Stone and Mal Hartley for being my animated best mates.

Central St Martins College of Art and Design for their support and the use of SoftImage XSI and Maya.

Cavendish College for their support and the use of 3d studio max.

Kent Braun for the use of DigiCel FlipBook.

Nick Manning of Autodesk Inc and Raj Dehil of Red Lorry Yellow Lorry for the loan of Maya and 3D Studio Max. Screen shots and models with permission of Autodesk Inc.



Many thanks to Ben Vost from NewTek, for permission to use screen shots and models from LightWave. LightWave 3D is a registered trademark of NewTek, Inc.

Christine Charette and Jennifer Goldfinch for the loan of SoftImage XSI. Images courtesy of SoftImage Co. and Avid Technology, Inc. Models created in SoftImage XSI.

Vasco Carou for the wonderful footage of his horse Inato (a thoroughbred Lusitano).

All of the students I have ever taught animation to (more that 600!) – believe me, I’ve learnt as much from you as you have from me. (A very big thank you to all the students who replied to my inane email questions.)

All the people I’ve known, argued with, watched, listened too, agreed with, ignored and generally experienced that have made me the animator I am today.

My Mum and Dad who had faith in me getting a job that involved scribbling all day.

But most of all Dee, Felix and Emily who haven’t seen nearly as much of me as they should have done for the past few years but have loved me all the same.

## chapter 1

# introduction to 2D-animation working practice

### chapter summary

- *how animation works  
the basics*
- *frames per second*
- *what you need for your studio  
animation paper  
peg bar  
light box  
x-sheets  
line tester  
pencils*
- *let's get animating  
key to key animation  
animating straight ahead*
- *flipping, flicking and rolling  
flipping  
flicking  
rolling*
- *how to use a line tester to help your animation*
- *how this book works*
- *exercises  
ball bouncing  
how to relate your 2D animation to your  
3D animation  
overview of the 'ball drop' exercise in 3D drawing!*

During this chapter I will take you through two things – the equipment needed to make a basic animation studio and some simple animation. We will look at x-sheets and how they help timing, flipping, flicking and rolling, how to use a line tester and how to put the lessons learnt from your drawn exercises onto a 3D-computer program. By the end of the chapter you will have learnt how to organize yourself and how to plan a piece of animation.

I make no apologies for taking you right back to basics. Many of you may know much of this but bear with me – it is worth refreshing your knowledge and reinforcing the basic principles behind animation.

## **how animation works**

### *the basics*

2D drawn animation consists of a series of drawings shot one after another and played back to give the illusion of movement. This animation can be played back in a number of ways.

- In the form of a 'flipbook' (basically a pile of drawings in sequence, bound together and flipped with the thumb).
- The drawings could be shot on film one drawing at a time with a movie camera and played back using a cinema projector.
- They could be shot on a video camera and played back with a video player.
- They could be shot with a video camera attached to a computer and played back on the same computer using an animation program.
- Or they can be scanned into the computer and played back.

## **frames per second**

Animation shot on film and projected is played at 24 frames per second.

Animation for television in Europe, Africa, the Middle East and Australia is played at 25 frames per second. In these countries they use a television system called PAL which plays at 50 fields (frames) per second and 25 frames per second is compatible with this. If we played an animated film at 24 frames per second on the television, we would see a black bar rolling up the screen. The Americas, the West Indies and the Pacific Rim countries use NTSC, which runs at 60 fields per second. This means you should be animating at 30 frames per second (60 is divisible by 30). Quite often some sort of digital converter is used to transfer one speed of film to another speed of video, allowing 24 frames per second film to be shown on a 60 fields per second (NTSC) TV. If you stop frame through a video of an animated film, you will find there are points at which one frame will blur into another. This is how they overcome the incompatibility of the two systems (stop framing through animated movies is a very good way of learning about animation). The most important thing to find out when animating something is at what speed the animation will be played back. All the animation taught in this book will be played back at 25 frames per second.

## what you need for your studio

In order to complete all the drawn exercises in this book you will need the following things (all of which are available from the professional animation equipment suppliers listed at the back of this book):

- animation paper
- peg bar
- light box
- x-sheets
- line tester
- pencils



### animation paper

When animating, you often find that you are working with four or more layers of paper. A level of translucency is necessary to see all the drawings. Professional animation paper is made with this in mind.

It also comes in different sizes. These are referred to as field sizes – 12 field and 15 field are the most popular; 15 field is 15 inches wide, 12 field being 12 inches wide (I'll explain this in more detail later in the chapter when I refer to field guides, the grid that measures field sizes).

Most professional animation paper comes with three punched holes. It is possible to buy this paper with no holes. (This is cheaper but you will need a specialist animation punch, which is very expensive). Used with a peg bar, the holes allow accurate placing of each piece of paper with the next. This is important, as the slightest movement in a drawing will show when the sequence is shot.

It is possible to use A4 paper with standard ring binder punched holes and a peg bar with two pins that fit the holes. This will work out far cheaper than professional animation paper.

### peg bar

Professional peg bars are a strip of steel or plastic with three pins. These are industry standard and are used with professional animation paper. These are used to register each piece of animation paper against the next.

It is possible to buy two pin peg bars – these are often called junior peg bars.

It is equally possible to make your own using a strip of wood with two pieces of dowel that correspond to the holes in your paper, or even to tape two 5 mm countersunk bolts onto your

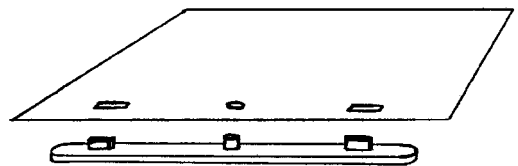
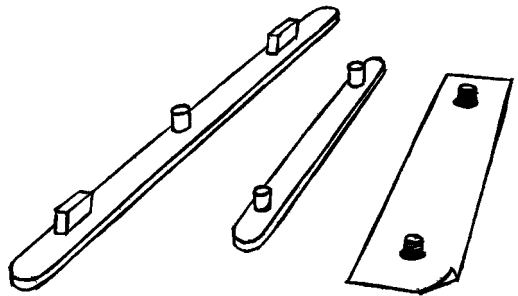
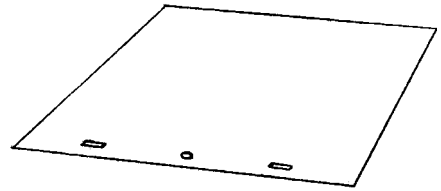

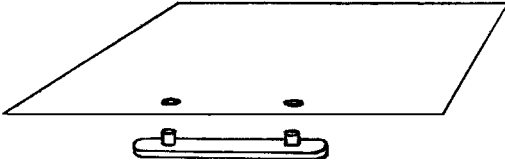

light box. These can then be used with ring binder punched A4 paper.

As with the paper, bear in mind that if you want to use your animation professionally, it is advisable to buy a three-pin peg bar.

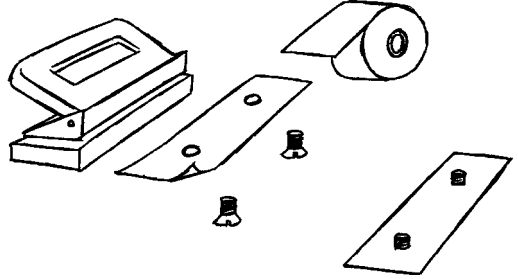

## *light box*

In its most basic form, a light box is a flat sheet of opal Perspex over a light. Professional light boxes use a rotating disc. They should also have the ability to change the angle of the drawing surface. This makes drawing easier both on the wrist and on the back.

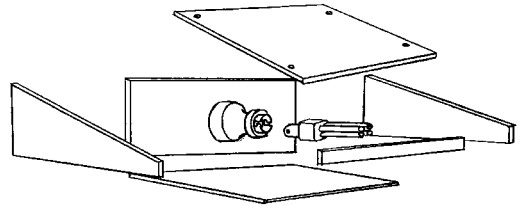
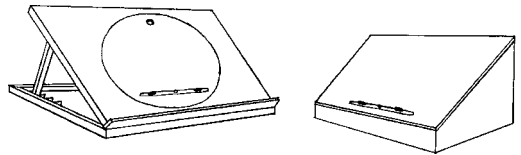

Simple light boxes are relatively straightforward to make. You could use a wooden storage box with the top part cut off at an angle with a neon bulb mounted inside. A piece of 6 mm opal Perspex is then fastened to the top with screws.

## *x-sheets*

X-sheets are also referred to as dope sheets or exposure sheets. They are used by the animator to record all the necessary information relating to how the animation should be shot. A standard x-sheet consists of several columns that run from top to bottom and 100 rows that run from left to right. Each row represents one frame of animation. If the animation is to be played back at 25 frames per second, 100 frames will equal 4 seconds of animation.

The columns on an x-sheet mean the following things.

### **1. sound column**

This contains the sounds that are relevant to the animation. Very often this is the dialogue spoken by the characters. For animation the dialogue is recorded first. It is then 'broken down'. This means that someone, usually an editor, will go through the sound track frame by frame. They work out where each word starts and ends and where each of the major vowel and consonant sounds are. These are then marked on the x-sheet in the sound column, frame by frame. You then know that at a certain frame in a scene a particular sound is made.

| ANIMATOR;   |       |        |              |   |   |         |   |   |           |        |
|-------------|-------|--------|--------------|---|---|---------|---|---|-----------|--------|
| PRODUCTION; |       |        |              |   |   |         |   |   |           |        |
| SCENE NO;   |       |        | SEQUENCE NO; |   |   | LENGTH; |   |   | SHEET NO; |        |
| NOTES;      |       |        |              |   |   |         |   |   |           |        |
| LEVELS;     |       |        |              |   |   |         |   |   |           |        |
| ACTION      | SOUND | FRM NO | 6            | 5 | 4 | 3       | 2 | 1 | B.G.      | CAMERA |
|             |       | 1      |              |   |   |         |   |   |           |        |
|             |       | 2      |              |   |   |         |   |   |           |        |
|             |       | 3      |              |   |   |         |   |   |           |        |
|             |       | 4      |              |   |   |         |   |   |           |        |
|             |       | 5      |              |   |   |         |   |   |           |        |
|             |       | 6      |              |   |   |         |   |   |           |        |
|             |       | 7      |              |   |   |         |   |   |           |        |
|             |       | 8      |              |   |   |         |   |   |           |        |
|             |       | 9      |              |   |   |         |   |   |           |        |
|             |       | 10     |              |   |   |         |   |   |           |        |
|             |       | 11     |              |   |   |         |   |   |           |        |
|             |       | 12     |              |   |   |         |   |   |           |        |
|             |       | 13     |              |   |   |         |   |   |           |        |
|             |       | 14     |              |   |   |         |   |   |           |        |
|             |       | 15     |              |   |   |         |   |   |           |        |
|             |       | 16     |              |   |   |         |   |   |           |        |
|             |       | 17     |              |   |   |         |   |   |           |        |
|             |       | 18     |              |   |   |         |   |   |           |        |
|             |       | 19     |              |   |   |         |   |   |           |        |
|             |       | 20     |              |   |   |         |   |   |           |        |
|             |       | 21     |              |   |   |         |   |   |           |        |
|             |       | 22     |              |   |   |         |   |   |           |        |
|             |       | 23     |              |   |   |         |   |   |           |        |
|             |       | 24     |              |   |   |         |   |   |           |        |
|             |       | 25     |              |   |   |         |   |   |           |        |
|             |       | 26     |              |   |   |         |   |   |           |        |
|             |       | 27     |              |   |   |         |   |   |           |        |
|             |       | 28     |              |   |   |         |   |   |           |        |
|             |       | 29     |              |   |   |         |   |   |           |        |
|             |       | 30     |              |   |   |         |   |   |           |        |
|             |       | 31     |              |   |   |         |   |   |           |        |
|             |       | 32     |              |   |   |         |   |   |           |        |
|             |       | 33     |              |   |   |         |   |   |           |        |
|             |       | 34     |              |   |   |         |   |   |           |        |
|             |       | 35     |              |   |   |         |   |   |           |        |
|             |       | 36     |              |   |   |         |   |   |           |        |
|             |       | 37     |              |   |   |         |   |   |           |        |
|             |       | 38     |              |   |   |         |   |   |           |        |
|             |       | 39     |              |   |   |         |   |   |           |        |
|             |       | 40     |              |   |   |         |   |   |           |        |
|             |       | 41     |              |   |   |         |   |   |           |        |
|             |       | 42     |              |   |   |         |   |   |           |        |
|             |       | 43     |              |   |   |         |   |   |           |        |
|             |       | 44     |              |   |   |         |   |   |           |        |
|             |       | 45     |              |   |   |         |   |   |           |        |
|             |       | 46     |              |   |   |         |   |   |           |        |
|             |       | 47     |              |   |   |         |   |   |           |        |
|             |       | 48     |              |   |   |         |   |   |           |        |
|             |       | 49     |              |   |   |         |   |   |           |        |
|             |       | 50     |              |   |   |         |   |   |           |        |

This blank x-sheet can be photocopied or you can print up an x-sheet from the folder X-SHEETS in chapter001 of the CD-ROM.

## 2. action column

This contains the instructions on when a given piece of animation will start and end. An experienced animator will fill out this part of the x-sheet before they start animating. Sometimes the director will fill this out. The process is often referred to as 'slugging out'.

|             |       |               |   |         |   |            |   |   |      |        |
|-------------|-------|---------------|---|---------|---|------------|---|---|------|--------|
| ANIMATOR:   |       |               |   |         |   |            |   |   |      |        |
| PRODUCTION: |       |               |   |         |   |            |   |   |      |        |
| SCENE NO.:  |       | SEQUENCE NO.: |   | LENGTH: |   | SHEET NO.: |   |   |      |        |
| NOTES:      |       |               |   |         |   |            |   |   |      |        |
| LEVELS:     |       |               |   |         |   |            |   |   |      |        |
| ACTION      | SOUND | FRM NO        | 6 | 5       | 4 | 3          | 2 | 1 | B.G. | CAMERA |
|             |       | 1             |   |         |   |            |   |   |      |        |
|             |       | 2             |   |         |   |            |   |   |      |        |
|             |       | 3             |   |         |   |            |   |   |      |        |
|             |       | 4             |   |         |   |            |   |   |      |        |
|             |       | 5             |   |         |   |            |   |   |      |        |
|             |       | 6             |   |         |   |            |   |   |      |        |

|   |       |               |   |         |   |            |   |   |      |                 |
|---|-------|---------------|---|---------|---|------------|---|---|------|-----------------|
| ANIMATOR: STEVE ROBERTS                                       |       |               |   |         |   |            |   |   |      |                 |
| PRODUCTION: BOUNCING BALL                                     |       |               |   |         |   |            |   |   |      |                 |
| SCENE NO.:  |       | SEQUENCE NO.: |   | LENGTH: |   | SHEET NO.: |   |   |      |                 |
| 3   |       | 2             |   | 3 SECS  |   | 1          |   |   |      |                 |
| NOTES: BALL BOUNCES INTO SCREEN, HITS GROUND AND BOUNCES OUT! |       |               |   |         |   |            |   |   |      |                 |
| LEVELS:   |       |               |   |         |   |            |   |   |      |                 |
| ACTION  | SOUND | FRM NO        | 6 | 5       | 4 | 3          | 2 | 1 | B.G. | CAMERA          |
|   |       | 1             |   |         |   |            |   |   | 1    | B.G.1           |
|   |       | 2             |   |         |   |            |   |   |      |                 |
|   |       | 3             |   |         |   |            |   | 2 |      | 12 FIELD CENTRE |
|   |       | 4             |   |         |   |            |   |   |      |                 |
|   |       | 5             |   |         |   |            |   | 3 |      |                 |
|   |       | 6             |   |         |   |            |   |   |      |                 |
|   |       | 7             |   |         |   |            |   | 4 |      |                 |

### 3. the frame numbers column

As the heading suggests, this is where the number of each frame is inserted. One of the main ways of 'cheating' in drawn animation is to do your animation on 'twos'. This means that each of your drawings is shot for two frames. This saves a huge amount of work. For example, if you have to animate 4 seconds you only have to do 50 drawings, rather than 100 drawings if you did a drawing for each frame (assuming a rate of 25 frames per second). You will also find that at times you will want to 'hold' your animation. For example, at a given point in the action a character may move into a position where they stand still for a second or so. At this point you could just have one drawing 'held' for however many frames are needed.

There are two ways to number your drawings. The first way is to number them by the drawing. This means that drawing number one will be numbered 1, drawing number two will be numbered 2, etc. The other way is to number them by the frame. This means that the drawing on frame one will be numbered 1. The drawing on frame three (if the sequence is shot on twos, this would be the second drawing) will be numbered 3, the drawing on frame five would be numbered 5, etc. Each method has its advantages and disadvantages. It is probably better

| SOUND | FRM NO |
|-------|--------|
| H     | 1      |
| E     | 2      |
| L     | 3      |
| O     | 4      |
|       | 5      |
|       | 6      |
|       | 7      |
|       | 8      |
| H     | 9      |
| O     | 10     |
|       | 11     |
| W     | 12     |
|       | 13     |
| A     | 14     |
| R     | 15     |
|       | 16     |
|       | 17     |
|       | 18     |
|       | 19     |
|       | 20     |
|       | 21     |
|       | 22     |
|       | 23     |
|       | 24     |
|       | 25     |

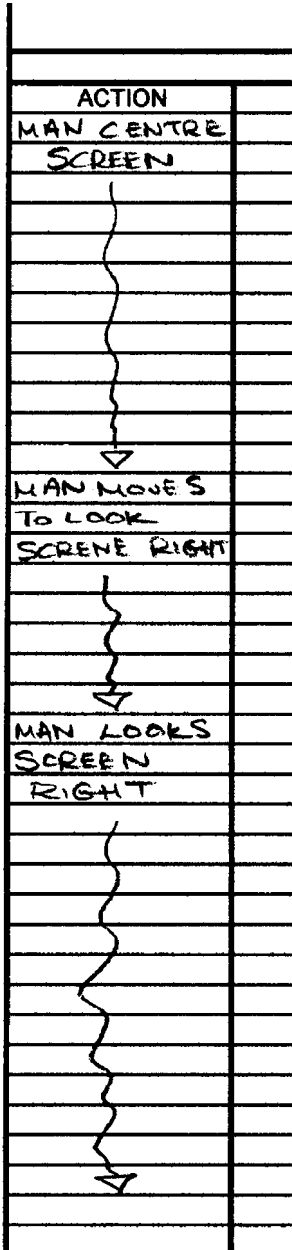

|        | LEVEL |
|--------|-------|
| FRM NO | 6     |
| 1      |       |
| 2      |       |
| 3      |       |
| 4      |       |
| 5      |       |
| 6      |       |
| 7      |       |
| 8      |       |
| 9      |       |
| 10     |       |

for the aspiring computer animator to number drawings by the frame so that when you look at your drawings in order to copy their position with your computer model you know exactly what frame that pose should be on. All the exercises done in this book will be numbered by the frame.

The columns show the order in which the levels are placed. Background at the bottom level, foreground at the top with the character in the middle.

| 2 | 1  | B.G. | CAMERA                |
|---|----|------|-----------------------|
|   | 1  | BG-1 |                       |
|   | 3  |      | 12<br>FIELD<br>CENTRE |
|   | 5  |      |                       |
|   | 7  |      |                       |
|   | 9  |      |                       |
|   | 11 |      |                       |

Numbered by the frame

| 2 | 1 | B.G. | CAMERA                |
|---|---|------|-----------------------|
|   | 1 | BG-1 |                       |
|   | 2 |      | 12<br>FIELD<br>CENTRE |
|   | 3 |      |                       |
|   | 4 |      |                       |
|   | 5 |      |                       |
|   | 6 |      |                       |

Numbered by the drawing

Each drawing will have its own number. Each unit represents a frame. The drawing number is inserted to show where that frame of animation will be in the sequence. This varies depending on how many frames per second each drawing represents. The example shows a sequence that is shot on twos (i.e. each drawing is

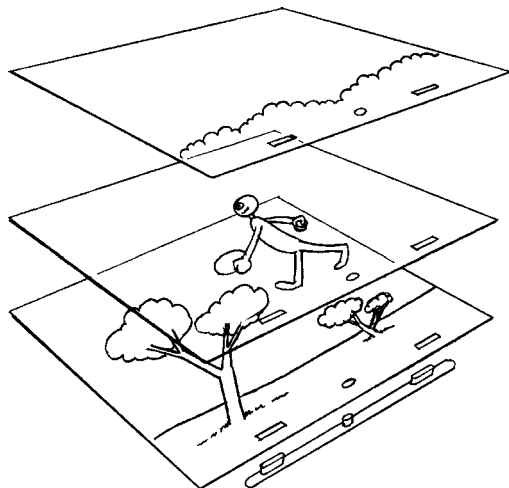



shot for two frames). When something is on twos the first row has a number and the second is left blank. It is unnecessary to fill in every frame, if at the end of a sequence the last drawing is held for 10 frames (i.e. the drawing is shot for 10 frames) a line should be drawn for the 9 frames after the written number. This is indicated by the line that runs from the bottom of the drawing number to the last frame that the drawing is held for. If the drawing is held for more than two frames, it is necessary to insert a line to show how long the drawing is held for.

#### 4. the levels columns

When a sequence is animated, even if there is only one character, the drawing for one frame of animation may be on several levels of paper. If the body remains still during the sequence, but the head and arms are moving, there will be only one drawing of the body for the whole sequence. If the head is moving at a different rate to the arms, the head will be on a separate piece of paper and the arms on a further piece. If there is a background and the character is stood behind, for example a tree, this will again be on a separate piece of paper. However accurate the final drawings are, if you have to retrace exactly the same drawing 20 times or more, there will be variations between the drawings that will show when the animation is played. It also is an unnecessary use of time. Before the use of computers, the finished drawings were traced and coloured onto Cel (cellulose acetate or clear plastic sheets). This allowed for a maximum of six levels before the thickness of the cell made the colours on the lower levels look muddy. Today, each of these levels would be painted and assembled together with programs such as Soft|Image Toonz or Animo. This allows for infinite levels without any loss of quality.

| LEVELS: |   |   |   |   |      |        |
|---------|---|---|---|---|------|--------|
| 0       | 6 | 5 | 4 | 3 | 2    | 1 B.G. |
|         |   |   |   |   | OL 1 | BG-1   |
|         |   |   |   |   | A 3  |        |
|         |   |   |   |   | A 5  |        |
|         |   |   |   |   | A 7  |        |
|         |   |   |   |   | A 9  |        |

#### 5. the camera column

Information in this column instructs the camera how you want the scene to be shot and pinpoints the area within the artwork.

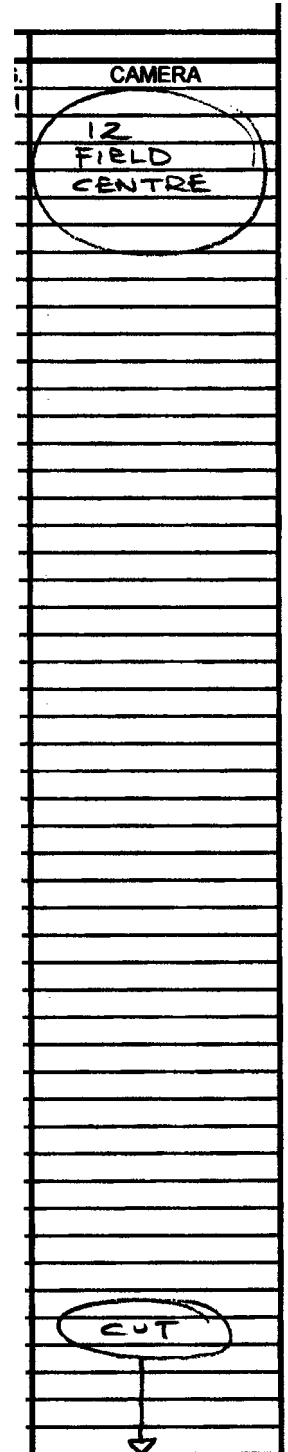

The most important piece of information is the field size. The most popular paper is 12 field, which means that the camera at its maximum setting will shoot an oblong area that is 12 inches wide.

Traditional 2D animators use a field guide, also called a graticule, to work out the position of the shot. For example, to shoot your animation using the full size of the paper it is marked on the top of the camera column as 12-field centre. As a 3D-computer animator, you won't be using field sizes. However it is worth understanding how they are worked out.

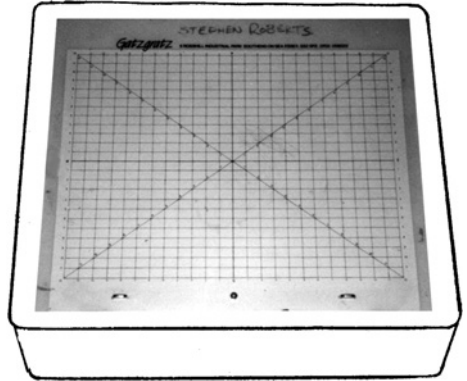

The field guide has North, South, East and West printed at the top, bottom, right and left. It consists of 24 columns and 24 rows in a grid. The columns are half an inch wide. By using these compass points and grid references you can specify any area on your paper that you want to be shot.

The illustration below shows an oblong area at the top right of the paper that is 5 inches wide. This would be 5 field at 7 east/7 north of 12-field centre. Using the field guide you work out where the centre of the oblong is in relation to 12-field centre (the centre of the field guide). To find the centre you would count along 7 lines east and 7 lines north from the centre of the field guide (12-field centre). See illustrations over page.

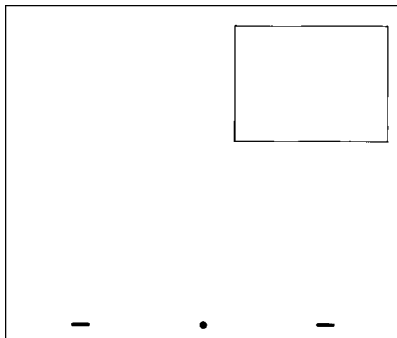
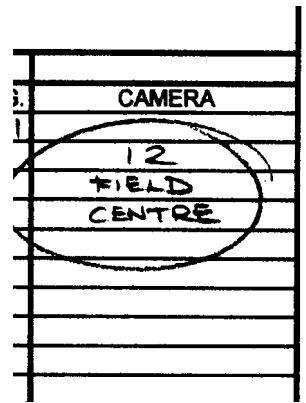

Using this method, you can place a field of any size in any area.

All exercises in this book are at 12-field centre (or if you are using A4 photocopy paper, 10 field at 2 south of 12-field centre).



## line tester

A line tester is a device that captures your drawings and plays them back. It is a quick and easy way to see if the roughly drawn sequence works. There are a number of ways to set up a line tester. You could use a film camera, a video recorder that can record single frames or

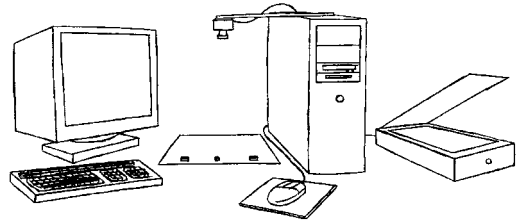
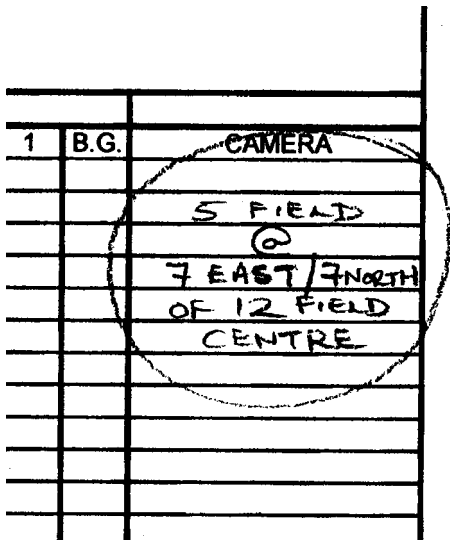
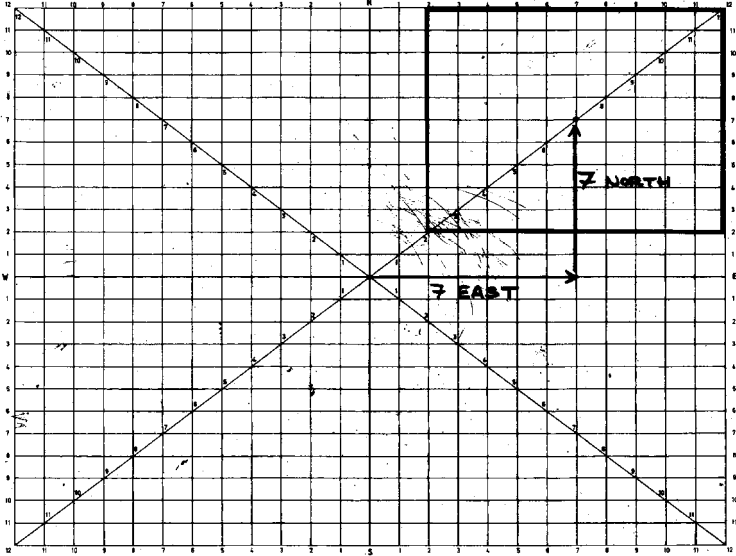

a line testing software program and a computer. The movie examples on the CD-ROM were produced using a program called 'Digicel Flipbook' (there is a demonstration copy on the CD-ROM with instructions). Other alternatives are available. I would suggest looking for a program that contains an x-sheet, as this is best for working out timing.

The simplest and cheapest way of setting up a line tester is to use a web-cam together with a computer and the line testing software. Set the camera to point down onto the table. The camera could be mounted on a tripod or even stuck to a steel rule that is then attached to the top of your computer. Stick your peg bar to the table, put a piece of your animation paper onto it and align it under the camera. The peg bar is important for the accurate placing of drawings. It is also possible to scan drawings into the computer using a flatbed scanner, but it takes an awful lot longer than using a camera.

Now would be a good time to load the demo copy of Digicel Flipbook onto your PC and familiarize yourself with its operation.

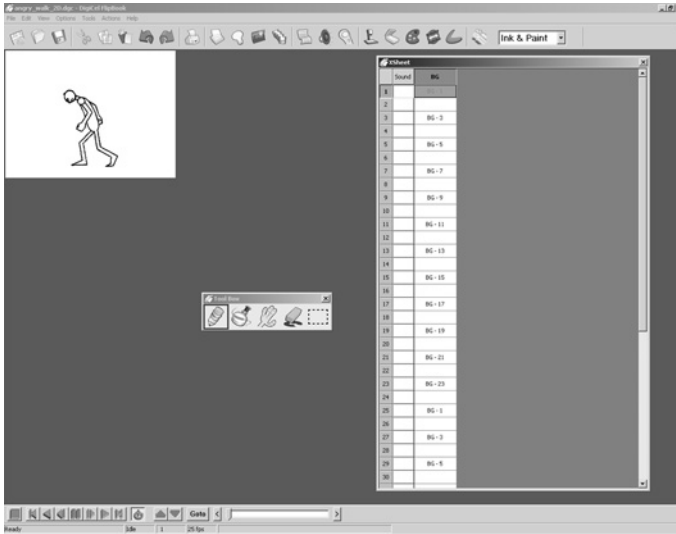

## pencils

When doing drawn animation it's always best to work in rough with a Col-Erase blue pencil and then 'clean up' your drawings afterwards with a graphite pencil. This means you can define the correct lines of the character and add details in graphite pencil on top of the rough Col-Erase lines. Also, when you line test your animation the graphite line will show up more distinctly than the blue lines underneath.

An HB or B pencil is needed for the clean drawing whilst a coloured pencil is used for roughing out the animation. Sold under the trade name of Col-Erase, these are coloured pencils that can be easily erased and are great for drawing with. You can work rough with a graphite pencil but it can get very confusing when it comes to cleaning up the drawings.



## let's get animating

There are two ways to animate a sequence using traditional 2D animation. These are animating 'key to key' (also known as 'pose to pose') and 'straight ahead'.

### key to key animation

'Key drawings', also referred to as 'keys', are important drawings that sum up the essence of the action during a scene.

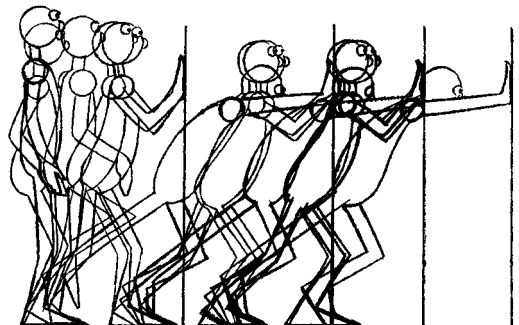

Key to key animation is when the 'key positions' or 'poses' in a sequence are drawn before completing the sections between them ('in-betweening'). I always like to think of the key positions as being the plot or a précis of a scene. They give a rough overall feel of the animation. The in-between drawings ('in-betweens') provide the characterization or detail.

Animating key to key allows for a large degree of control over your animation. It can prevent the character or object from changing size or distorting where you don't want it. It also means you have control over the timing of your animation and can more easily predict what action will happen when and where. By line testing the keys you can see the basic movement of a sequence before completing the full animation.

In the end all the frames of your animation are important and if you put too much emphasis on the key positions the animation can look clunky and stiff.

Below is an example of key to key animation.

A man sits at a table with a glass of liquid on it. He picks up the glass and drinks from it.

- Key number 1 – He looks at the glass.
- Key number 2 – He grasps the glass in his hand.
- Key number 3 – He raises the glass to his lips.
- Key number 4 – He tips the contents of the glass into his mouth.

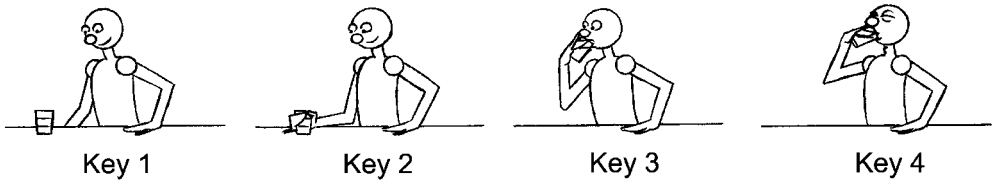

How many in-betweens and where they are positioned (the timing) depends upon the character and the mood of the man.

If he was thirsty, he would quickly grab the glass (only a few in-between drawings and spaced far apart) pull the glass up swiftly to his lips (maybe spilling some liquid), pulling back his head and tipping it straight down his throat.

To create the illusion of speed you have less in-betweens with larger gaps between each drawing.

If he was an alcoholic he may pick up the glass carefully to avoid spilling any liquid (a lot of in-between drawings, positioned closely together). Just before the glass reaches his lips he might dip his head, so as to avoid spilling any liquid in case his arm fails. He would then drink long and slowly.

To show slower movements there are more in-betweens and smaller gaps between the drawings.

If the man were hesitant about drinking the liquid, he may pull his hand back just before grasping the glass and, holding it with the tips of his fingers, bring it slowly and delicately to his lips so he could take a small sip.

## *animating straight ahead*

This is when images in the sequence are drawn directly one after the other. It can produce a more vibrant form of animation with more energy and exuberance. Unfortunately there is far less control with straight-ahead animation and distortion and changes in size are more likely. It is also more difficult to work out the timing because you can only check the animation with a line tester when it is all done and then it may be wrong and you have to throw away a lot of drawings and redo it.



## **flipping, flicking and rolling**

There are three skills that are invaluable when animating with pencils and paper. These are flipping, flicking and rolling. These allow you to see the drawings moving while you are animating. To practise these skills, we are going to animate a ball bouncing into the screen, hitting the ground and then bouncing out of the screen. Each of these bounces describes an arc, which is referred to as a parabola.

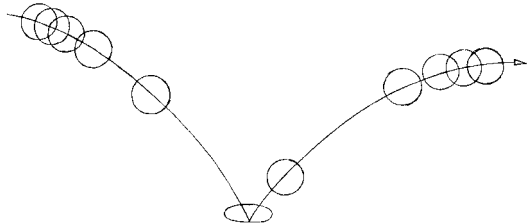

This is a good example of timing in animation. To create the dynamics of the movement of the ball, the drawings are spaced at different intervals. As the ball bounces, it accelerates towards the ground in an arc, pulled by the force of gravity. At the fastest point the drawings are furthest apart. At the highest point of the bounce (the apex) the ball is travelling more slowly. Here the drawings are closer together. To create acceleration as the ball falls to the ground, the drawings of the ball are placed further and further apart. As the ball hits the ground, it squashes down, absorbing the energy of the fall. It then un-squashes and accelerates into the next bounce, slowing down as it reaches the apex of this next bounce.

This principle of animation timing is relevant to all animation. The closer the drawings are together, the slower the movement, the further apart they are then the quicker the movement.

## *flipping*

Grab an old exercise book, sketchbook or block of Post-It notes. With these we are going to make a flipbook. We are going to use this flipbook to bounce a ball across the page using straight-ahead animation.

With the spine furthest away from you, lift the pages until the bottom page is facing you. Draw the ball in the top left-hand corner of the bottom page of your flipbook. Following the illustration draw one ball on each subsequent page. When the ball hits the ground remember to squash it so that it is almost flat. As it leaves the ground, stretch the ball along the arc it is following.

When you have completed the sequence, hold the flipbook at the spine with your right hand, place your left thumb at the bottom of the flipbook, with the left-hand index and forefinger at

the top page of the flipbook. Bend the flipbook up towards you with your left hand and allow the pages of the flipbook to slide away from your thumb. All being well you should see your ball fall in an arc from the top left of the page to the centre bottom of the page where it squashes and bounces up to the top right of the page (open *flipbook.avi* in *chapter001* of the CD-ROM for a demonstration of how to do this).

You have just created a piece of straight-ahead animation, i.e. where images are drawn one after the other.

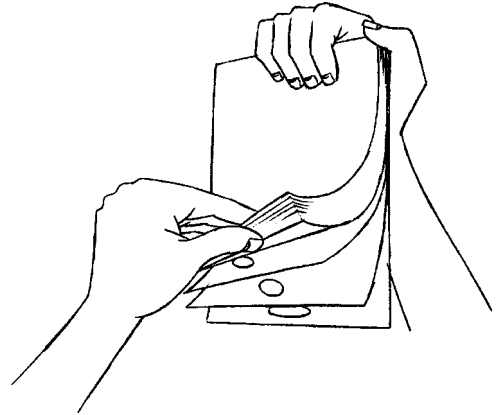

This exercise should have given you an idea about timing and spacing. Try experimenting with the distance between one ball and the next (e.g. if the balls are very close together they will move slowly and appear to float).

Flipping is a good way to see how your animation is working when you are using animation paper. Arrange your drawings with the first drawing of the sequence at the bottom of the pile and the last drawing at the top. This is called the flipping order. Hold up your drawings with your right hand at the top of the pile and your left hand at the bottom. As with the flipbook, pull the drawings towards you and let the drawings slide off your left-hand thumb one at a time as they fall flat. If this is too awkward (your pile of drawings is too thin), try putting some blank pages on top of these drawings to make the pile thicker (open up *flipping.avi* in *movies001*, *chapter001* of the CD-ROM).

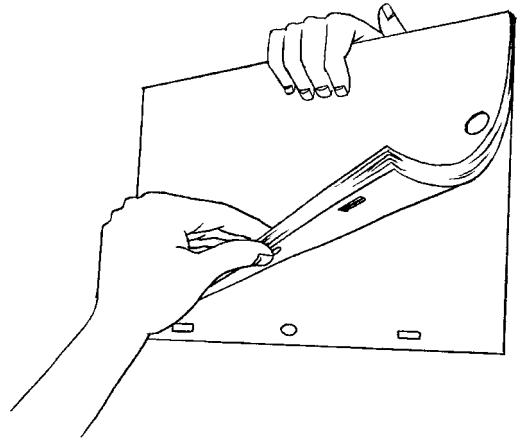

## *flicking*

Flicking is a technique used to look at your animation while you are sitting at your light box. When mastered it means you can see how your animation is moving and you can adjust your animation accordingly by re-drawing.

For this next exercise we will use our punched paper, the peg bar and light box. Put your light box on the table in front of you in a comfortable position.

Always animate with the peg bar at the bottom of your piece of paper. It's much more difficult to flip and flick with the peg bar at the top.

We are going to animate a piece of key to key animation using the same sequence as for the flipping exercise. We will be numbering these drawings by the frame and each drawing will be shot for two frames (twos).

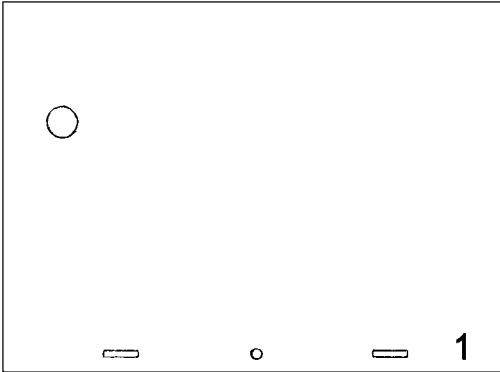

Place your first sheet of paper onto the peg bar. At the bottom right-hand corner of the paper, label this drawing no.1. This is our first key drawing.

Place a second sheet on top, using the peg bar to register it. Draw a squashed ball and label it drawing no.11. This is our second key drawing.

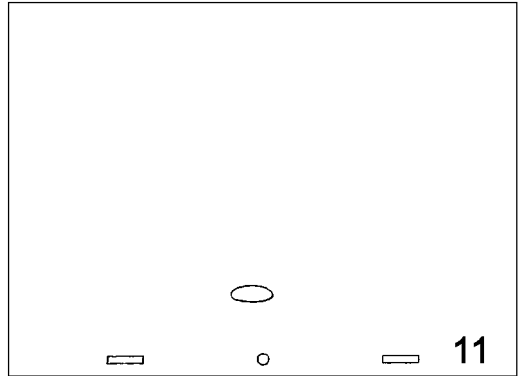

Lastly place a third sheet over the previous two and draw a ball at the top right-hand corner and label this drawing no.21. This is our third and final key drawing.

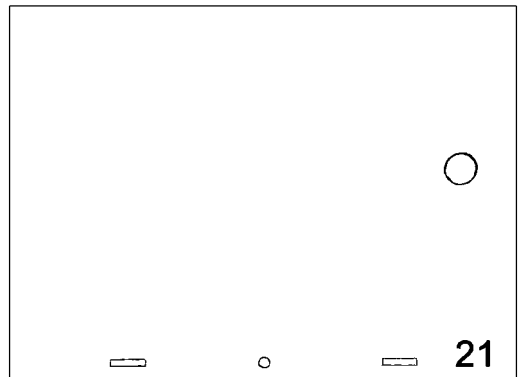

Remove drawing no.21. We will in-between drawings no.1 to no.11. This means we will draw the drawings that go between no.1 and no.11.

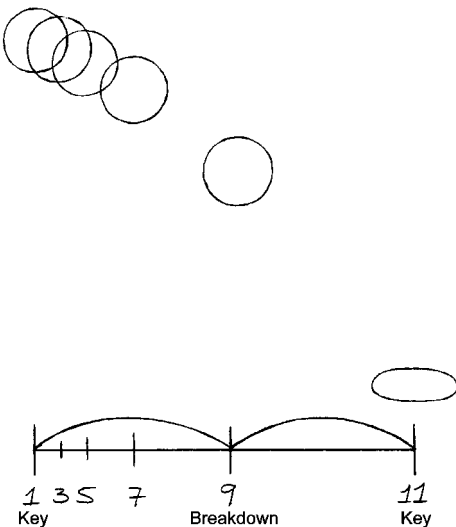

The first in-between we draw will be no.9. This is half way between no.1 and no.11. This may seem rather odd, but it will help give the impression of the ball speeding up as it hits the ground. If we look at the timing chart, we see that, because the ball was at its slowest on the apex, there are more drawings closer together at this point. As the ball falls out of the sky the drawings get further and further apart. This is why the drawing half way between no.1 and no.11, is drawing no.9.

The first drawing you do as an in-between is often referred to as a 'breakdown' drawing. This is the major in-between.



Timing charts (also known as breakdown guides, in-betweening guides or telegraph poles) are used to show where the in-between images should be drawn. They are generally placed at the bottom of the key drawing and should relate to the drawings between that key and the next. They consist of a horizontal line with a vertical line at each end representing the key drawings. The breakdown (major in-between) drawings are indicated by a vertical line with a couple of arcs between it and the key drawings. The remaining in-between drawings are represented by shorter vertical marks.

This illustration shows the breakdown guide for drawings no.1 to no.11.

Drawing no.7 is half way between no.1 and no.9, drawing no.5 is half way between no.1 and no.7 and drawing no.3 is half way between drawing no.1 and drawing no.5.

When we in-between our sequence, we need to 'flick' our drawings. Place drawing no.11 over drawing no.1 and a clean sheet over these. Label it drawing no.9. Hold

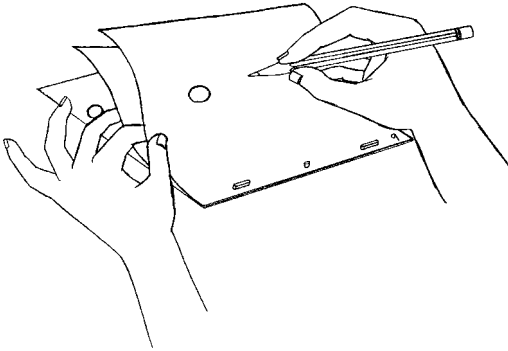
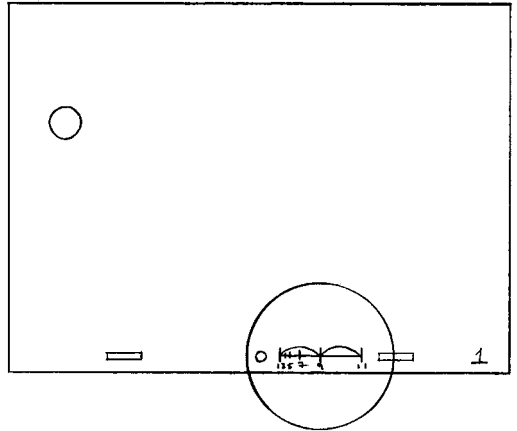

drawing no.9 with your left thumb and fore-finger. Slip your index finger underneath drawing no.11. Leave drawing no.1 flat on the light box.

Now draw the ball on drawing no.9. Remember the ball is moving through an arc and that it should be half way between the balls on drawings no.1 and no.11.

In order to see how the ball is moving, fold back drawings no.11 and no.9 towards you

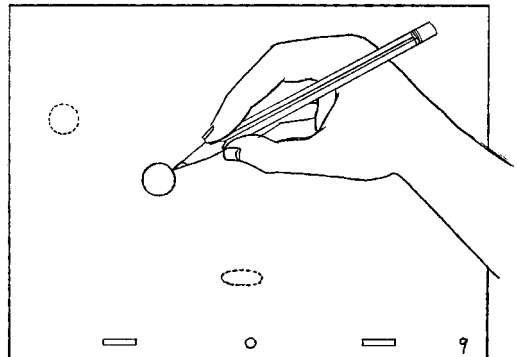
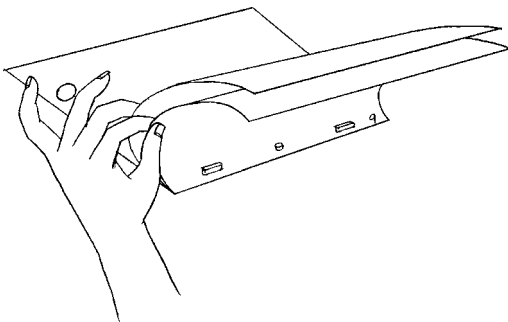

(while still attached to the peg bar) and look at drawing no.1.

Fold drawings no.11 and no.9 flat against the light box and look at drawing no.9.

Then fold drawing no.9 up towards you and look at drawing no.11.

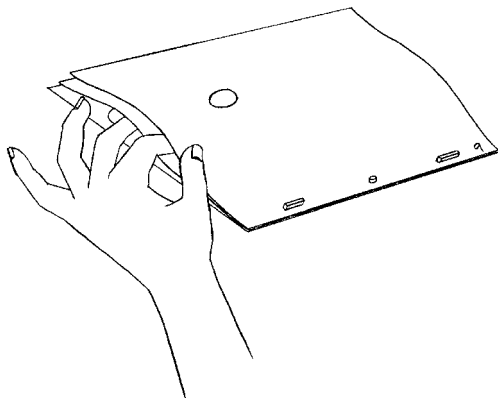
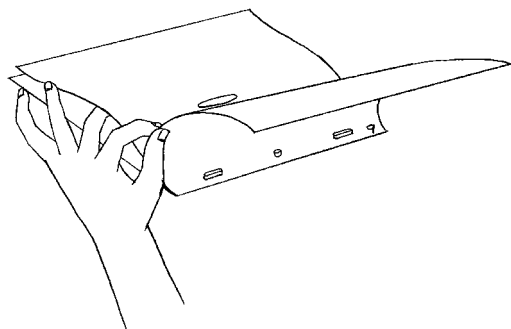

When this is done in quick succession the ball will move along the arc. You are now flicking. Sometimes it helps to put a rubber band over the pins on the peg bar to stop the paper slipping off. If the ball in drawing no.9 doesn't appear to be in the correct position,

rub it out and re-draw it. Keep flicking and drawing until it looks right. (See flicking.avi in movies001, chapter001 of the CD-ROM.)

Repeat the in-betweening process for drawing no.7 (between drawing no.1 and no.9), drawing no.5 (between drawing no.1 and no.7) and drawing no.3 (between drawing no.1 and no.5). Once you've drawn all these you can have a go at rolling.

## *rolling*

Place the first five drawings of the sequence onto the peg bar with drawing no.1 at the bottom and no.9 at the top. Interleave each of these drawings between the fingers of your left hand. You can only ever roll with five drawings.

Fold all the drawings towards you and look at drawing no.1. By moving your little finger forward allow drawing no.3 to fall flat over drawing no.1 and look at this. See top illustration on p. 18.

Let drawing no.5 fall flat over drawing no.3. Look at this. Let drawing no.7 fall flat over drawing no.5. Look at this. Finally allow drawing no.9 to fall flat onto drawing no.7 and look at this. Bring your hand back and repeat the process. Make sure your fingers stay interleaved with the paper at all times. When this is done in quick succession, you will see the ball falling from the top left of the

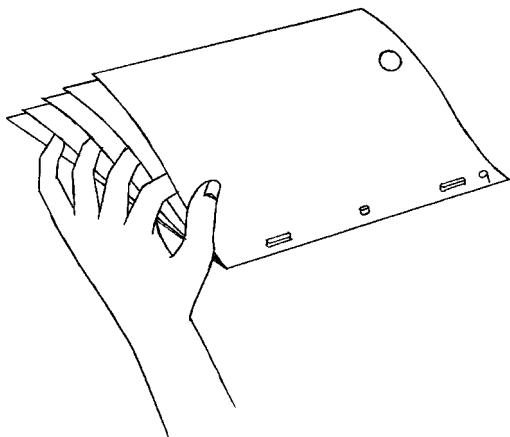

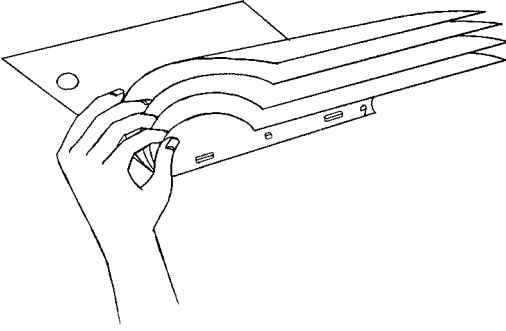

page and hitting the ground, accelerating as it falls. You are now rolling (see `rolling.avi` in `movies001`, `chapter001` of the CD-ROM).

Complete the exercise by in-betweening drawings no.11 through to no.21.

This is the timing chart for drawing no.11, showing how you should in-between the drawings between drawing no.11 and no.21.

The X in the chart shows that the distance has been divided into three. The first in-between you will do is drawing no.15. This is the breakdown drawing. It is one-third closer to no.21 and two-thirds further away from no.11. (The X is there to show the relative position of drawing no.15.) The next drawing to do is no.17. This is half way between no.15 and no.21. Then do drawing no.19. This is half way between no.17 and no.21.

There is no drawing at the position X. The next drawing to do is no.13. This is half way between X and no.11. By using this spacing, the ball will accelerate from drawing no.9 and decelerate as it reaches no.17. Make sure the ball follows the arc through the sequence. When you have completed all the drawings have a go at flipping them. Pick up all the drawings you've animated with the first number at the bottom and the last at the top. Hold them up with the right hand and flip with the left.

Finally shoot the sequence with the line tester to see accurately how the animation moves. Each drawing should be shot for two frames each. If you haven't worked out how to use a line tester yet, never fear! I'm going to take you through how to use one in the next section (see `ball_bounce.avi` in `animations001`, `chapter001` of the CD-ROM).

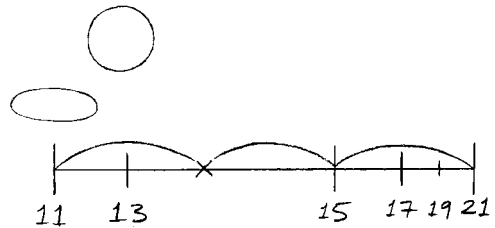
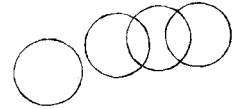

## how to use a line tester to help your animation

In the last exercise we looked at the timing for a ball bouncing across the screen. Learning the timing for the key positions is one of the hardest things in animation to do. Using a line tester enables you to see how the timing is working and will hopefully help you to learn timing skills more quickly.

For the next exercise we will make a ball drop into screen, fall straight to the ground and bounce a few times before coming to a halt.

The first thing to do is to animate and shoot the key drawings on the line tester. The resulting movie is called a pose test or a key test. The number of frames that each of the key drawings

is played back for can be adjusted on the x-sheet part of the program. When this is working satisfactorily, the drawing numbers are marked onto a paper x-sheet and from this the timing for the in-between drawings are worked out. Work out timing charts for where the in-betweens will go. Do the in-betweens and finally the entire sequence is shot on the line tester.

## how this book works

Every exercise in this book will follow the basic format below. Animate the exercise in 2D and then use the drawings as a guide to how the animation will move in 3D. Computer program specific .pdf notes will be found on the CD-ROM.

### exercises

#### *ball bouncing*

Draw the following key positions onto each subsequent piece of paper and number them as shown.

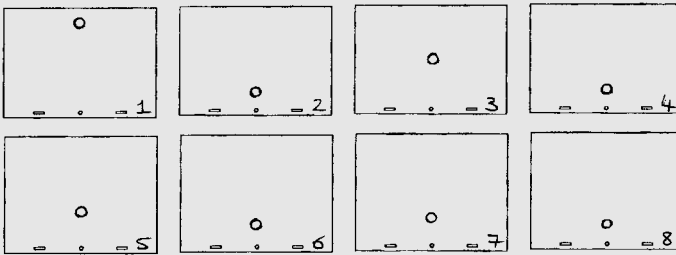

Open up DigiCel Flipbook on your computer. Click Create New Scene. Specify a Frame Rate of 25. # of frames = 44. # of levels = 2. Click the radio button for PAL (768 × 576). Then click OK.

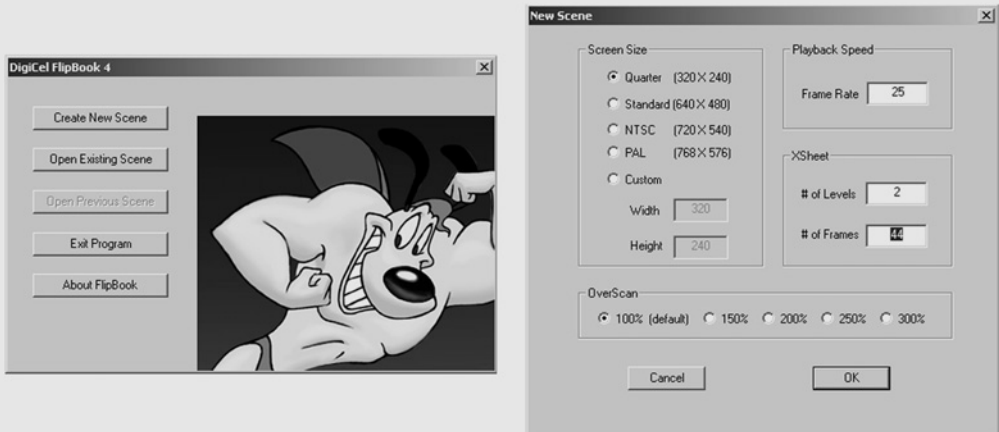

If you are going to be using a video camera, click on the Capture icon. Hopefully up will come a live screen of what your camera is seeing and a Video Capture toolbar.



We need to play the key drawings back at roughly the same speed and length as the finished sequence. (Remember that we have yet to do all the in-betweens for this piece of animation.) We do this by 'holding' each of the key drawings for the estimated number of frames between each of the keys. The line test helps us to work out the number of frames needed. We need to see this sequence as a series of keys that demonstrate the main positions for the correct timing. In DigiCel Flipbook you can specify how many frames each key drawing is captured for (the Hold box on the Video Capture toolbar) and you can also adjust the amount of frames the drawing is held for on the x-sheet part of the program.

We now need to capture your key drawings. For this exercise we will start by capturing each drawing for 1 frame each.

On the Video Capture tool bar set the Frame box to 1 and set the Hold box to 1. This means that when they are captured your drawings will be numbered the same as above. These are referred to as the key numbers. Set the Level box to 1.

Place key drawing no.1 under the camera and when it is positioned correctly on the peg bar, left click on the Capture button. Place key drawing no.2 under the camera and press the Capture button. Repeat this process for all eight key drawings. When you have captured all your keys, press the Quit button. Now press the Play Forward button at the bottom of the DigiCel FlipBook window. It's running a bit fast isn't it? That's because it's running on 'singles'. This means that each drawing is being played back for one frame. The way to correct the timing and slow it down is to make each of the key drawings 'hold' for longer than one frame. To do this we need to drag each of the key drawings down the dope sheet for the appropriate number of frames.

If you look at the XSheet panel you will see that the drawings are called 1-1 to 1-8. This is because they are on the Back Ground level.

In the XSheet window left click onto 1-2. Left click on it again whilst holding down the Alt key on your keyboard and drag it down the XSheet until 1-2 is next to the frame number 9 on the XSheet window.

|    | Sound | 1   | BG  |
|----|-------|-----|-----|
| 1  |       | 1-1 |     |
| 2  |       |     |     |
| 3  |       |     |     |
| 4  |       |     |     |
| 5  |       |     |     |
| 6  |       |     |     |
| 7  |       |     |     |
| 8  |       |     |     |
| 9  |       |     | 1-2 |
| 10 |       | 1-3 |     |
| 11 |       | 1-4 |     |
| 12 |       | 1-5 |     |
| 13 |       | 1-6 |     |
| 14 |       | 1-7 |     |
| 15 |       | 1-8 |     |
| 16 |       |     |     |

This means that key no.1 (1-1 on the XSheet window) is now held for 8 frames. This means that when it is played back your audience will see it for 8 frames.

Click on 1-3 and (while holding the Alt key) drag that down to frame 17. This means that key no.2 (1-2) is held for 8 frames.

Drag 1-4 down to frame 23. Drag 1-5 down to frame 29, 1-6 down to frame 33, 1-7 down to frame 37 and finally drag 1-8 down to frame 41.

When you have adjusted the XSheet, press the Play Forward button on the main screen. How does your animation look?

(You can compare your key sequence with the ball\_drop\_keys.avi in animations001, chapter001 of the CD-ROM.)

It will be jerky, but at this stage that doesn't matter. The important thing is to work out the timing. You have to imagine what it would look like when it has all the in-between drawings included. This is a skill that comes with experience. The more you animate and look at pose tests, the more adept you become at working out the correct timing.

If any of your key drawings appear to be playing for too long or too short a period, 'hold' them for less or more frames. With Digicel Flipbook, highlight it on the XSheet by left clicking on the image that you want to change the frame value of. Then click on it a second time and hold the mouse button down, while holding down the Alt key on the keyboard. Drag the column up or down depending on whether you want to lengthen or shorten the amount of frames.

When you are happy with the result, mark the key positions onto a paper x-sheet (photocopy up the one I put in the book earlier or print the x-sheets found in the folder X-SHEETS in chapter001 of the CD-ROM). Use the far-left level column and use a pencil (these keys are marked here for temporary reference). If key drawing 1 starts on frame 1 of the digicel XSheet, mark it into frame one of the paper x-sheet. If key drawing 2 starts on frame 9 of the digicel XSheet mark it onto frame 9 of the paper x-sheet and so on. If the animation is on twos we need to know where these will be during the sequence. In the far right level column mark in the correct drawing numbers, i.e. drawing 1 on frame 1, drawing 3 on frame 3, etc. See illustration on p. 22.

You can now re-number your key drawings by the frame number they correspond to. Key drawing 2 corresponds with frame 9 so we re-number it drawing no.9! Key 3 is drawing 17, key 4 is drawing 23, key 5 is drawing 29, key 6 is drawing 33, key 7 is drawing 37 and key 8 is drawing 41. Draw a ring around each of the key drawing frame numbers (see top illustration on p. 23). Erase the key numbers in the far-left level column. Re-number your key animation drawings as per the frame number.

The next stage is to work out the in-between drawings and place a timing chart at the bottom of each key. Remember that to show a gain in speed as the ball is dropped, the drawings will be further and further apart.

| XSheet |     | LEVELS: |    |   |   |   |   |    | CAMERA |         |
|--------|-----|---------|----|---|---|---|---|----|--------|---------|
| Sound  | EG  | FRM NO  | 6  | 5 | 4 | 3 | 2 | 1  | B.G.   |         |
| 1      | 1-1 | 1       | K1 |   |   |   |   | 2  |        | 12      |
| 2      |     | 2       |    |   |   |   |   |    |        | FIELD   |
| 3      |     | 3       |    |   |   |   |   | 3  |        | CENTRE. |
| 4      |     | 4       |    |   |   |   |   |    |        |         |
| 5      |     | 5       |    |   |   |   |   | 5  |        |         |
| 6      |     | 6       |    |   |   |   |   |    |        |         |
| 7      |     | 7       |    |   |   |   |   | 7  |        |         |
| 8      |     | 8       |    |   |   |   |   |    |        |         |
| 9      | 1-2 | 9       | K2 |   |   |   |   | 9  |        |         |
| 10     |     | 10      |    |   |   |   |   |    |        |         |
| 11     |     | 11      |    |   |   |   |   | 11 |        |         |
| 12     |     | 12      |    |   |   |   |   |    |        |         |
| 13     |     | 13      |    |   |   |   |   | 13 |        |         |
| 14     |     | 14      |    |   |   |   |   |    |        |         |
| 15     |     | 15      |    |   |   |   |   | 15 |        |         |
| 16     |     | 16      |    |   |   |   |   |    |        |         |
| 17     | 1-3 | 17      | K3 |   |   |   |   | 17 |        |         |
| 18     |     | 18      |    |   |   |   |   |    |        |         |
| 19     |     | 19      |    |   |   |   |   | 19 |        |         |
| 20     |     | 20      |    |   |   |   |   |    |        |         |
| 21     |     | 21      |    |   |   |   |   | 21 |        |         |
| 22     |     | 22      |    |   |   |   |   |    |        |         |
| 23     | 1-4 | 23      | K4 |   |   |   |   | 23 |        |         |
| 24     |     | 24      |    |   |   |   |   |    |        |         |
| 25     |     | 25      |    |   |   |   |   | 25 |        |         |
| 26     |     | 26      |    |   |   |   |   |    |        |         |
| 27     |     | 27      |    |   |   |   |   | 27 |        |         |
| 28     |     | 28      |    |   |   |   |   |    |        |         |
| 29     | 1-5 | 29      | K5 |   |   |   |   | 29 |        |         |
| 30     |     | 30      |    |   |   |   |   |    |        |         |
| 31     |     | 31      |    |   |   |   |   | 31 |        |         |
| 32     |     | 32      |    |   |   |   |   |    |        |         |
| 33     | 1-6 | 33      | K6 |   |   |   |   | 33 |        |         |
| 34     |     | 34      |    |   |   |   |   |    |        |         |
| 35     |     | 35      |    |   |   |   |   | 35 |        |         |
| 36     |     | 36      |    |   |   |   |   |    |        |         |
| 37     | 1-7 | 37      | K7 |   |   |   |   | 37 |        |         |
| 38     |     | 38      |    |   |   |   |   |    |        |         |
| 39     |     | 39      |    |   |   |   |   | 39 |        |         |
| 40     |     | 40      |    |   |   |   |   |    |        |         |
| 41     | 1-8 | 41      | K8 |   |   |   |   | 41 |        | CUT     |
| 42     |     | 42      |    |   |   |   |   |    |        |         |
| 43     |     | 43      |    |   |   |   |   |    |        |         |
| 44     |     | 44      |    |   |   |   |   |    |        |         |
| 45     |     | 45      |    |   |   |   |   |    |        |         |
| 46     |     | 46      |    |   |   |   |   |    |        |         |
| 47     |     | 47      |    |   |   |   |   |    |        |         |
| 48     |     | 48      |    |   |   |   |   |    |        |         |
| 49     |     | 49      |    |   |   |   |   |    |        |         |
| 50     |     | 50      |    |   |   |   |   |    |        |         |

The bottom illustration on p. 23 shows the timing charts for all the keys and the correct numbering. As the ball bounces up, it will accelerate to the optimum speed and then start to slow as gravity takes over, and it reaches the apex of the bounce. As the ball hits the ground for the second time, the squash will be slightly less (it will have fallen from a lower height). This pattern is repeated for the remaining bounces. Each bounce will be lower and lower until the ball comes to a stop.

Complete the in-between drawings for the sequence by following the timing charts and then line test it (shoot each drawing for two frames each).

You may have or may want to work out your own timing for the sequence. The finished piece of animation should be similar to the balldrop.avi in animations001, chapter001 of the CD-ROM.

### *how to relate your 2D animation to your 3D animation*

There are specific .pdf files called Maya\_info, XSI\_info, 3DSMax\_info and LightWave\_info in the file, chapter001 of the CD-ROM. These show the basics of each of these programs.

It might be a good idea to print them up and stick them on the wall by your computer. (You could copy them onto any Personal organizer that will display .pdf files, I have them all on my Psion organizer!) Take a look at the .pdf file that relates to your program and then have a go at the following exercise.

### overview of the 'ball drop' exercise in 3D

(In order to do this exercise have a look at 3DSMax\_balldrop.pdf, LightWave\_balldrop.pdf, Maya\_balldrop.pdf or XSI\_balldrop.pdf to find out how to do this in more detail.)

Open up your 3D-computer program and take out the 'balldrop' animation drawings and the related x-sheet (or have a look at the illustration below). Create a ball. Make sure that the Timeslider or Frameslider is at the first frame and move the ball to a position similar to drawing no.1 of your 2D animation. Set a key position.

Move the Timeslider/Frameslider to frame 9 and position the ball as in drawing number 9 (the second key position).

Copy each of the key positions from your animation onto the computer in this way and setting a key at the key positions of your drawn animation.

| LEVELS: |   |   |   |   |   |    | B.G.   | CAMERA |
|---------|---|---|---|---|---|----|--------|--------|
| FRM NO  | 6 | 5 | 4 | 3 | 2 | 1  |        |        |
| 1       |   |   |   |   |   | 1  | 12     |        |
| 2       |   |   |   |   |   | 2  | FIELD  |        |
| 3       |   |   |   |   |   | 3  | CENTRE |        |
| 4       |   |   |   |   |   | 4  |        |        |
| 5       |   |   |   |   |   | 5  |        |        |
| 6       |   |   |   |   |   | 6  |        |        |
| 7       |   |   |   |   |   | 7  |        |        |
| 8       |   |   |   |   |   | 8  |        |        |
| 9       |   |   |   |   |   | 9  |        |        |
| 10      |   |   |   |   |   | 10 |        |        |
| 11      |   |   |   |   |   | 11 |        |        |
| 12      |   |   |   |   |   | 12 |        |        |
| 13      |   |   |   |   |   | 13 |        |        |
| 14      |   |   |   |   |   | 14 |        |        |
| 15      |   |   |   |   |   | 15 |        |        |
| 16      |   |   |   |   |   | 16 |        |        |
| 17      |   |   |   |   |   | 17 |        |        |
| 18      |   |   |   |   |   | 18 |        |        |
| 19      |   |   |   |   |   | 19 |        |        |
| 20      |   |   |   |   |   | 20 |        |        |
| 21      |   |   |   |   |   | 21 |        |        |
| 22      |   |   |   |   |   | 22 |        |        |
| 23      |   |   |   |   |   | 23 |        |        |
| 24      |   |   |   |   |   | 24 |        |        |
| 25      |   |   |   |   |   | 25 |        |        |
| 26      |   |   |   |   |   | 26 |        |        |
| 27      |   |   |   |   |   | 27 |        |        |
| 28      |   |   |   |   |   | 28 |        |        |
| 29      |   |   |   |   |   | 29 |        |        |
| 30      |   |   |   |   |   | 30 |        |        |
| 31      |   |   |   |   |   | 31 |        |        |
| 32      |   |   |   |   |   | 32 |        |        |
| 33      |   |   |   |   |   | 33 |        |        |
| 34      |   |   |   |   |   | 34 |        |        |
| 35      |   |   |   |   |   | 35 |        |        |
| 36      |   |   |   |   |   | 36 |        |        |
| 37      |   |   |   |   |   | 37 |        |        |
| 38      |   |   |   |   |   | 38 |        |        |
| 39      |   |   |   |   |   | 39 |        |        |
| 40      |   |   |   |   |   | 40 |        |        |
| 41      |   |   |   |   |   | 41 | CVT    |        |
| 42      |   |   |   |   |   | 42 |        |        |
| 43      |   |   |   |   |   | 43 |        |        |
| 44      |   |   |   |   |   | 44 |        |        |
| 45      |   |   |   |   |   | 45 |        |        |
| 46      |   |   |   |   |   | 46 |        |        |
| 47      |   |   |   |   |   | 47 |        |        |
| 48      |   |   |   |   |   | 48 |        |        |
| 49      |   |   |   |   |   | 49 |        |        |
| 50      |   |   |   |   |   | 50 |        |        |

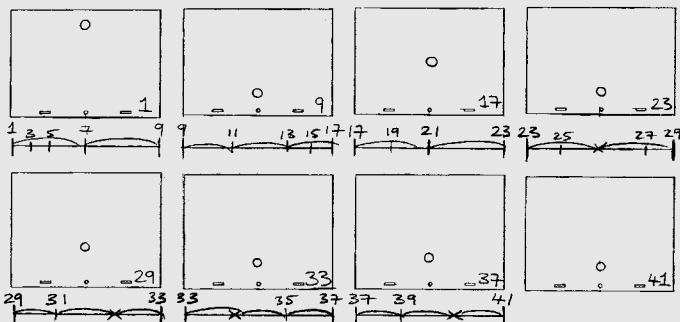



Play back your animation (or have a look at `ball_drop_keys_3D.avi` in `animations001`, `chapter001` of the CD-ROM). It will look odd because of the way the program in-betweens the key positions. It does this by accelerating out of one key and decelerating into the next. In order to adjust this we

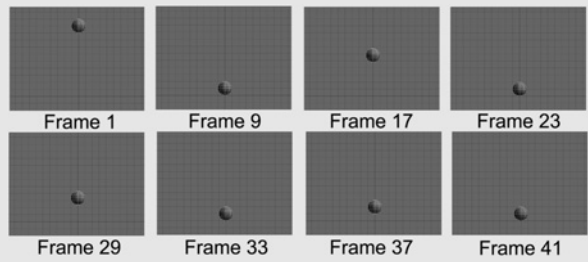

need to manipulate the Curves (called either Animation Curves or Function Curves) that relate to the animation of the ball. In all 3D-computer animation programs the movement is broken down into a graph-like mathematical interpretation. If you take the up and down movement of the ball as the vertical value and the time it takes to do it as the horizontal value, you will end up with a series of points on the graph where you have set your key frames. The computer program will join these points together to produce a curve and this will provide the in-between movement of your object. The default type of line linking the curves is called a 'Spline'.

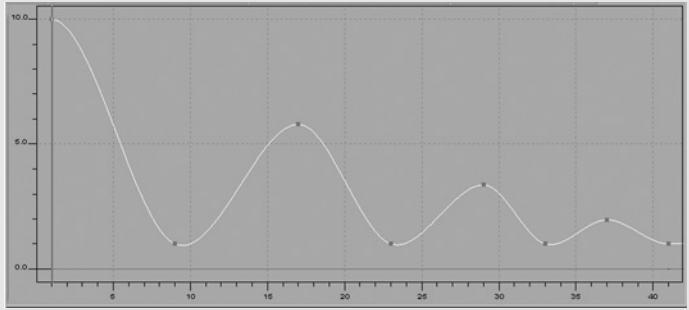

You can change the way the computer in-betweens

your key positions by adjusting these curves. There are a number of different options. 'Linear' is a straight line between each key. 'stepped' or 'constant' line continues at the same value as the first key, before jumping to the value of the next key.

The key points can also be given 'handles' making it possible to adjust the angle of the curve (curves with handles can be called 'bezier splines').

For our bouncy ball we need to 'break' the curve at the key position where the ball hits the ground. This means we need to make the curve ascend and descend between the keys in a nice parabola. From here we need to have a second parabola for the second bounce, a third parabola for the third bounce and so on.

Take a look at `ball_drop_3D.avi` in `animations001`, `chapter001` of the CD-ROM. The ball is now bouncing more like a ball should!

Of course I don't expect you to always work this way, but while you are learning to animate it will help you pick up timing all the quicker. By the end of the book you will only need to work out the basic key positions in 2D (in a very rough form) before animating in 3D.

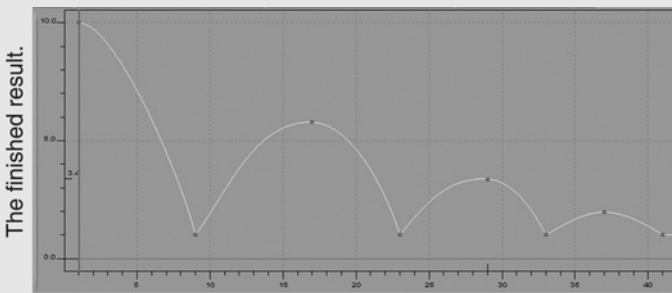
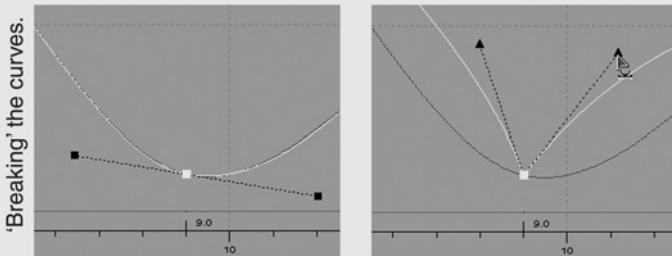
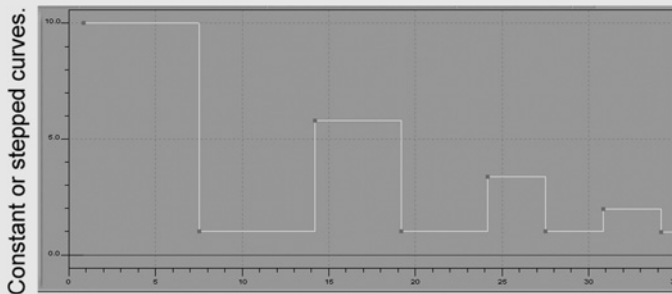
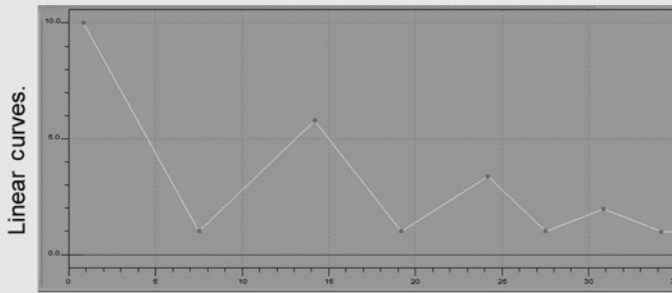

## *drawing!*

A good animator (whether 2D or 3D) should be able to sketch out a pose for a key frame of animation in a simple concise form. You don't have to be brilliant at drawing. However, drawing is the best way there is to interpret the world around you. So draw as much as possible. Drawing something means you observe it for a relatively long period

of time, helping you to understand the way it moves.

Attend life drawing classes and focus on short poses (less than 10 minutes). If the model is going to pose for an hour or two, draw them from one angle for a short period of time and then move around the room and draw them from another angle. The reason for this is that it teaches you to capture the essence of a pose with a few simple lines. Concentrate on getting the structure, weight and balance correct.

Go to zoos and sketch the animals. You'll have to draw quickly in order to capture an animal on the move! This will be far more informative than drawing from books or from the TV.

Sit at street cafés or in parks and draw the people around you. This is a great way to find out about human nature. How do people talk to each other, how do they walk, sit, run and play?

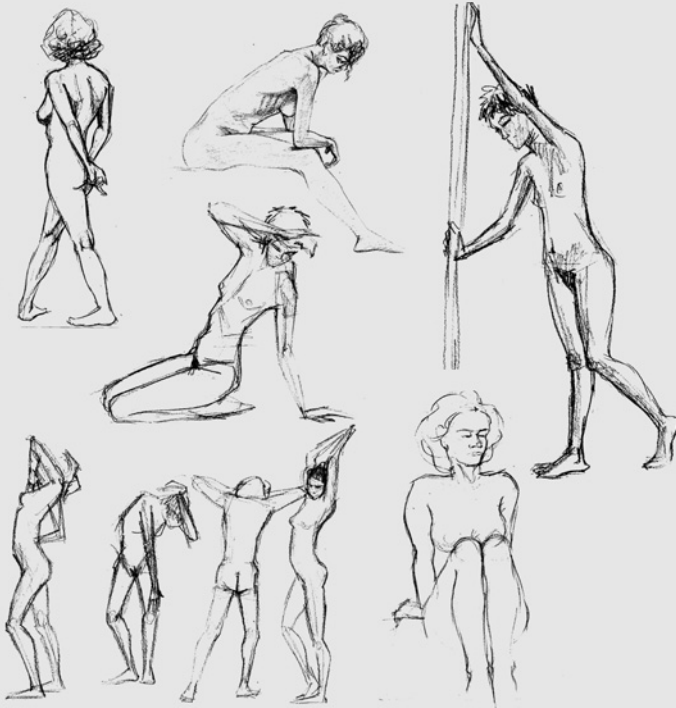
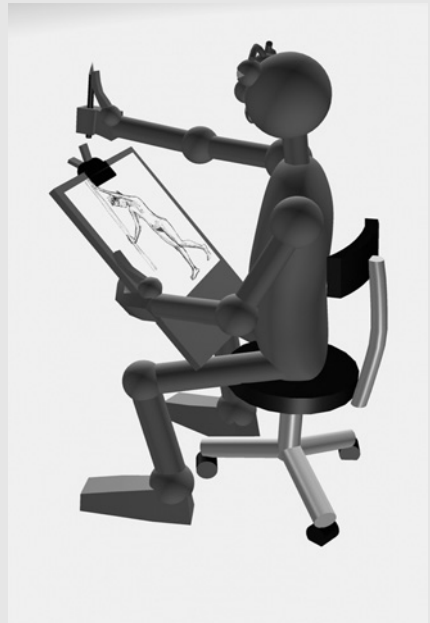

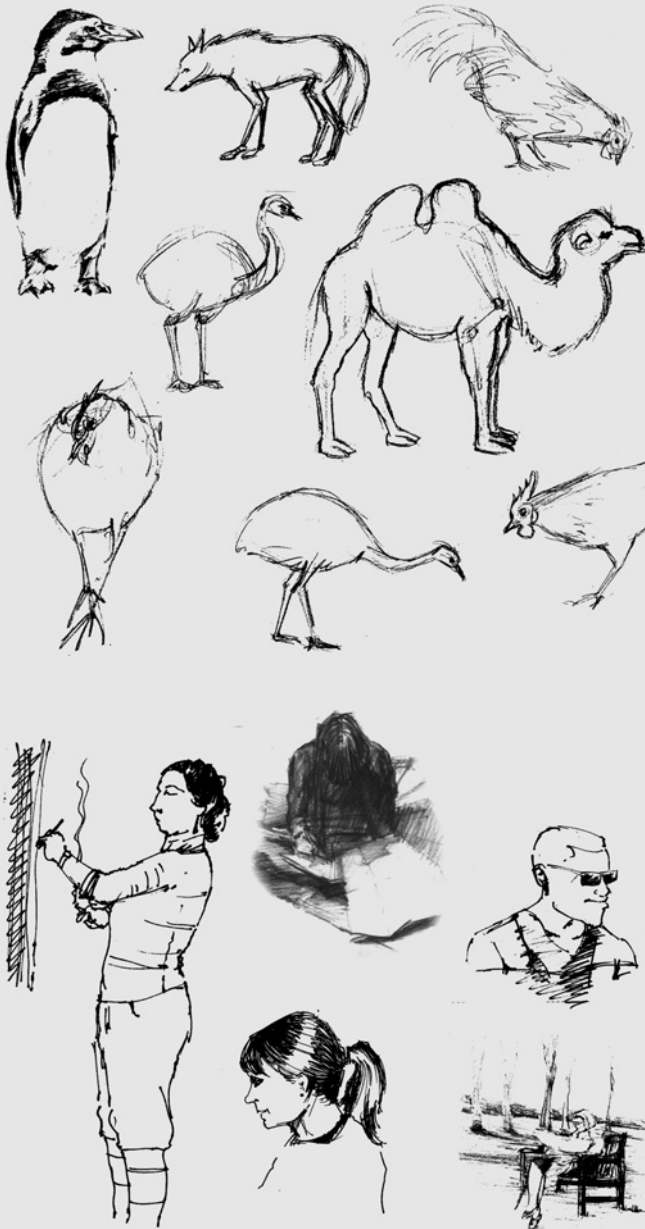

The most important thing about drawing is that it makes you sit down and look at the world around you in detail. Things that you would not normally notice, the way people pick things up, the faces they pull or the body language that they adopt become more apparent to you. A sketchbook is valuable reference material for your animation.

## chapter 2

# matter and the animation of inanimate objects

### chapter summary

- *inanimate objects*
  - weight*
  - environment*
  - solidity*
  - force*
  - construction*
- *how to animate inanimate objects*
- *the animation of solids*
  - a bowling ball*
  - a soccer ball*
  - a balloon*
  - a water-filled balloon*
- *the animation of liquids*
  - a drip*
  - a splash*
  - object falling into water*
- *exercises*
  - the bouncy ball in 2D*
  - animating a 2D bowling ball*
  - animating a 2D soccer ball*
  - animating a 2D beach ball*
  - animating a 2D ping-pong ball*
  - animating a 2D water-filled balloon*
  - the bouncy ball in 3D*

If you can cast your mind back to your first ever physics lesson, you were probably told that the world is divided into three states of matter: solid, liquid and gas. At some point you are going to animate all three of these. Just to make life difficult there are also energy sources you'll need to animate: electricity, fire and explosions. The animation of liquids, gases, electricity, fire and explosions are the preserve of the special effects animator and although I will touch on them in this book, they are not really in its remit. However, an understanding of the movement of solid inanimate objects is vital to the understanding of character animation and that's primarily what this chapter is about.

One thing that will always help your animation is to study real life. We are going to be spending most of this chapter looking at how balls bounce. Almost anything we need to know about the movement of matter can be condensed down to its most basic form with the movement of bouncing balls. So get some balls and start bouncing them!



This chapter is also about familiarizing yourself with the 3D program you are using. I've gone into a lot of detail with how to use your chosen program!

## inanimate objects

My definition of an inanimate object is any object that does not display 'life': these fall into two categories. The first are objects that do not move by themselves; they have to be dropped, pushed, pulled or propelled by an individual. The second are inanimate objects that are able to move. Cars, motorbikes, ships, aircraft, machines, engines, etc. I would still describe these things as inanimate objects because they are not alive, they show no character or emotion.

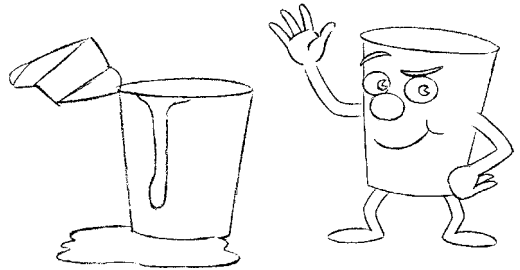

In animation there are many examples of previously inanimate objects that do display life. Cars, gas boilers, yoghurt pots, toilet cleaners, gherkins, etc., have all been given the breath of life by sticking on a couple of eyes, a mouth, some arms and some legs and animating them displaying emotions. These have all ceased to be inanimate objects.

When animating any inanimate object we have to take the following things into consideration.

### *weight*

How heavy is the object? A bowling ball will fall differently to a balloon.

## environment

A plank of wood on land may be very heavy but the same plank of wood floating in water will appear to be much lighter. Another consideration is interaction with other objects, for example, a person bowling a bowling ball. The ball rolls along gathering momentum before coming into contact with the skittles.

As it hits the skittles, the force from the bowling ball is transferred into the skittles causing them to fall over or leave the ground whilst the ball itself loses energy and therefore slows.

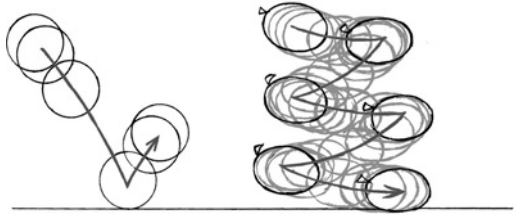

## solidity

How solid is your object? A brick when dropped will not display any squash and stretch as it hits the ground – if anything bits may fall off it with the impact. It has no inherent elasticity. A rubber ball will. Rubber has a lot of give. The force of the impact will cause the ball to squash down as it hits the ground before stretching as it rebounds into a bounce.

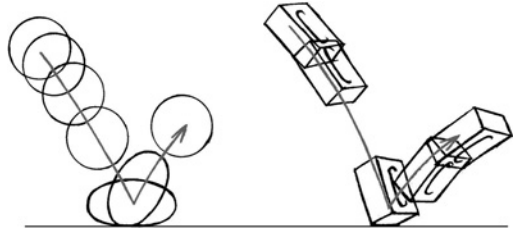

## force

What type of force is being applied to the object? A shot putter throwing a heavy ball will cause the ball to move in a different way to a cannon firing it!

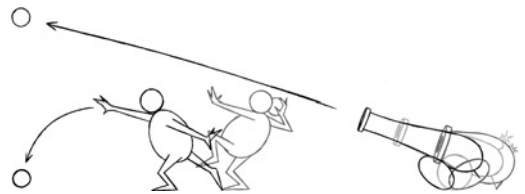

## construction

How is your inanimate object constructed? A balloon full of water will move differently from a solid box full of water. A feather will float down whereas a bowling ball will fall with great speed straight to the ground.



## how to animate inanimate objects

It's always best to base your animation on real life. Even the most cartoon like animation will have one foot in reality to make it believable. If your animation involves dropping a bowling ball, find a bowling ball and drop it. This way you can observe the motion! Bear in mind that to make the action more convincing for your audience, you will have to exaggerate the way the ball moves. All animation can be thought of as a performance, in the same

way that an actor will produce a performance that is an exaggerated version of real life. If you make the animation too 'realistic' it can often look stiff or insignificant. Exaggerating the movement can make a piece of animation more convincing.

A good example of this can be seen in many live action films that feature explosions. The explosion will usually be shown in slow motion. This emphasizes the power and force of the explosion drawing your attention to the smoke and debris flying through the air.

Think of all animation as being an exaggerated ideal of real life.



## the animation of solids

### *a bowling ball*

A bowling ball being dropped (this is a good example of a heavy object).

Once dropped, the bowling ball will accelerate rapidly to its optimum speed (deriving its energy from gravitational pull). It will then bounce (with no squash and stretch) as it hits the ground (unless it smashes straight through the floor, when it will keep going). The optimum speed is reached just before the ball hits the ground. As the ball is a solid object and is rigid, when it hits the ground it displays no squash and stretch. The weight of the ball combined with its rigidity means that the curve or angle of the bounce will be steep. As it accelerates away from the ground and decelerates into the apex, the movement will be short and quick before accelerating back towards the ground as gravitational pull takes over. This could be repeated a couple of times. The apex of the bounce will become lower each time. Each bounce will become increasingly closer together, whilst the curve of the bounce remains quite sharp.

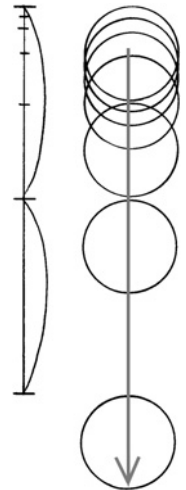

### animating this sequence

You start with a still picture of the ball being held. When the ball is dropped the time elapsed between each drawing rapidly increases until you reach optimum speed at which point the drawings will be an equal distance apart. This means that each subsequent ball will be further and further apart on the drawings.



When it hits the ground it will bounce. The reason it bounces is that when the ball hits the ground the energy contained within the ball has nowhere to go but back up, lifting the ball into a bounce. The ground absorbs a small amount of energy, which gives each bounce less power. The height of the first bounce will be lower than the height from which the ball was initially dropped. As more energy is absorbed by the ground, each successive bounce will be lower than the last.

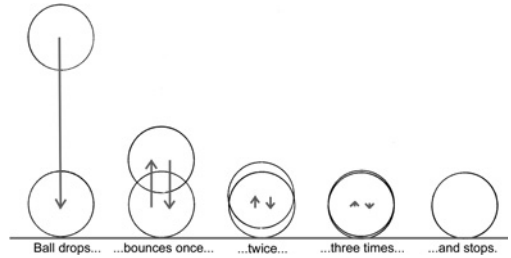

If you were to propel a bowling ball, the acceleration would be slow as you transfer energy from your hand to the ball. It's as if the ball is reluctant to take on the energy. You need to give it a very hard shove to get it going. The ball will be at its optimum speed as you stop pushing. Once it gets going the weight of the ball combined with the energy from the push gives it the momentum to keep it travelling and it will decelerate very slowly before stopping.

### animating this sequence

The first drawings of the hand propelling the bowling ball are close together, giving the initial thrust of speed. The time spacing between the drawings then increases gradually until the optimum speed is reached (the point at which the hand stops pushing the ball). The drawings gradually get closer and closer to each other as the speed of the ball slowly decreases and it comes to a graceful stop. It has to be remembered that a lot of energy has been passed to the ball to get it rolling. It has a large amount of momentum. So it will take a lot of force (or a very strong object) to stop it prematurely.

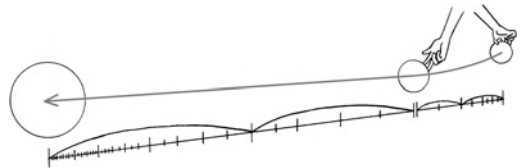

### a soccer ball

A soccer ball when dropped will accelerate at a slightly slower pace than a bowling ball. It will squash slightly as it hits the ground. The reason for this is that a football is flexible. It consists of a membrane holding in compressed air. As the ball hits the ground, the energy contained in the ball is forced outwards and not up because there is still energy at the top of the ball that will prevent the energy at the bottom of the ball from bouncing straight up. Only when the energy at the top of the ball has reached its lowest limit will the ball bounce up. Because a soccer ball is lighter than a bowling ball it is affected less by the pull of gravity as it bounces and will bounce higher, if they are both dropped from the same height. A membrane filled with compressed air has a certain amount of give, making it springier. This means that a soccer ball will also bounce more times than a bowling ball before coming to a stop.

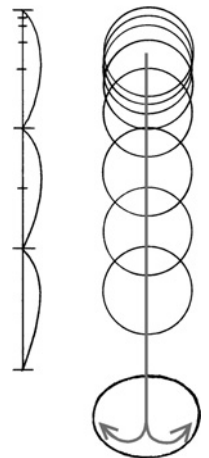

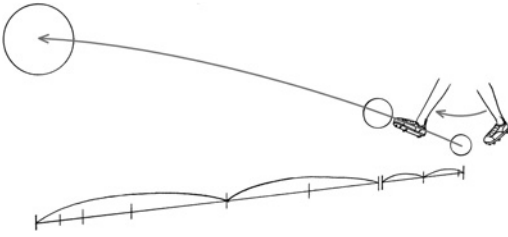

A soccer ball being kicked will be far easier to move than a bowling ball (it is a soccer ball after all). The energy will be passed easily from the foot to the ball and it will probably travel further than the bowling ball. It will be easier to stop though because it is flexible and will squash against any object in its path and it

doesn't contain as much kinetic energy as a shoved bowling ball.

### *a balloon*

A balloon, on the other hand, when dropped will accelerate very slowly to optimum speed, squash slightly, bounce slowly a couple of times (each time a smaller bounce) and come to a stop. The reason it squashes less than a football is that it has gained far less momentum from its fall, so there is less energy to push outwards at the point where it hits the ground. It will also slow down just before it hits the ground. This is because a balloon is so light a cushion of air above the ground will give a small amount of resistance and add to the impression of the balloon's lightness.

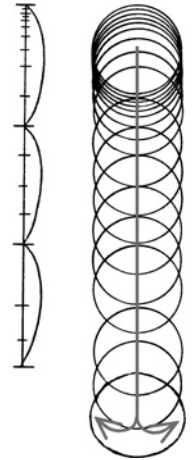

A balloon being pushed along the ground requires very little energy to get it moving, so it will accelerate rapidly to its optimum speed, but absorb a lot of energy by being squashed against the hand that is pushing it. As it leaves the hand it will decelerate rapidly to a stop. Very little energy has been passed to the balloon from the hand so it contains very little forward momentum. As such it will come to a stop rapidly.

### *a water-filled balloon*

A balloon full of water, when dropped will accelerate rapidly because it is heavy. It will also adopt a tear shape as it falls. This is because the balloon is a flexible membrane and all of the water wants to be at the bottom of the balloon because of gravity. The membrane will flex to a certain limit at the bottom of the balloon and any water that can't fit in at the bottom will stay at the top. When it hits the ground the water will push the membrane

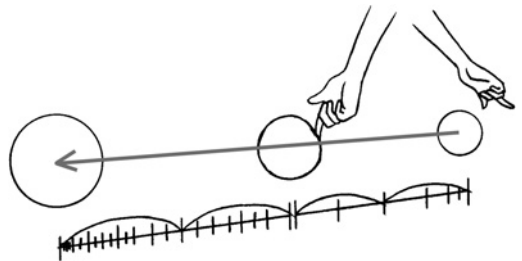

out sideways, helped by the water at the top of the balloon. When the water has pushed the membrane out as far as it will go (without bursting) the water is forced upwards all around the inner surface of the balloon's membrane. When it meets at the top, whatever energy there is will lift the balloon. As the balloon reaches the top of its apex the water will fall back down within the middle of the balloon. It hits the ground again and the water is forced outwards, causing another squash of the balloon. This time, because the force of the fall is less, the balloon will squash less. The water is forced upwards by the membrane of the balloon.

At the top it meets water coming from the other side of the balloon and is forced down. The balloon does not take off this time. The water circles round within the balloon and pushes the membrane out into another squash, this time even less than the last squash. This action can be repeated several times. The extent of the squash and the height to which the water travels to the top of the balloon gets less and less. Finally it will come to rest in a slightly squashed position.

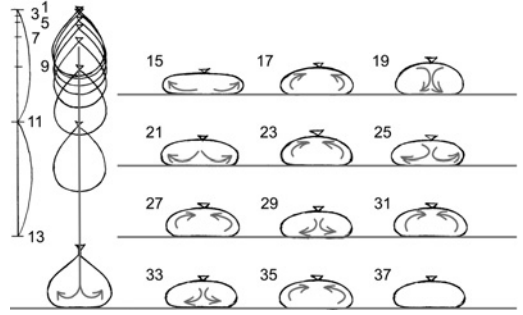

Depending on the force of the fall, the balloon will either burst, if dropped from a great height (because it will be travelling faster), or will not bounce into the air at all if dropped from a low height. It will just do the flexing upwards action.

If you try to push this water-filled balloon along the ground, the water absorbs a huge amount of the energy passed to it and rapidly comes to a halt. The water within the balloon is rotating round at a speed faster than the balloon is rotating along the ground. This produces a forward moving, undulating effect across the top of the balloon. The basic principle of what is happening is this. The water flows forward pushing the membrane at the front of the balloon until it reaches its elastic limit. This stretches the balloon out flat.



When this occurs, the water flows under itself towards the back of the balloon. When the water reaches the back of the balloon it is stopped flowing back by the rear part of the balloon's membrane. The water then goes up and over itself towards the front of the balloon pushing the membrane at the top of the balloon upwards as it goes. Finally to complete this cycle the water pushes against the front part of the balloon and we gain forward momentum. As this cyclical action is repeated the water is losing energy and is able to push against the membrane of the balloon less and less. So when the water is at the top of the balloon it will push up the membrane less and less. When the water is at the front of the balloon it will push the membrane forward less and less. You can see a very simplified version of what is happening in the illustration.

When the balloon comes to a halt the water within the balloon will still be rotating within it. The water does not have the force to push the balloon forward any more but it can affect the outer membrane shape. With the balloon now stationary, the water pushes the membrane as far forward as it can go

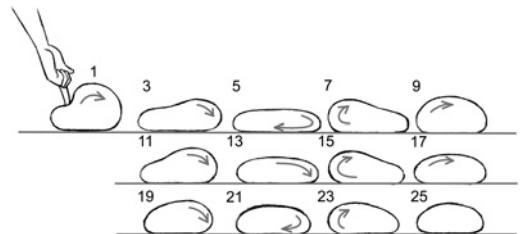

and then flows under itself, towards the back of the balloon. At the back of the balloon the membrane stops the water going back any further and forces the water up over the top of itself, pushing the membrane up. It flows toward the front of the balloon and pushes the membrane forward. As the water has less energy than the last time it was at the front of the balloon it will not push the membrane out as far as it did last time. The water will again flow under itself, towards the back of the balloon and repeat the same action as before but with less force. After this process has been repeated a few times, each time with less exaggeration, the balloon will come to a halt in a slightly squashed position.

All of these examples of how a water-filled balloon will move are animated at a much slower rate than a real water-filled balloon will move in real life. This is because an audience tends to understand what's going on in a piece of live action film more quickly than in an animated film. Consequently a lot of animation movement has to be slightly slower than movement in real life.

## the animation of liquids

### *a drip*

Liquids, unlike solids, have the ability to break apart and reform easily.

As it falls a drop of liquid takes on a tear shape (a bit like the water-filled balloon). Surface tension creates a membrane, which holds the majority of the water at the bottom of the drop. When the drop hits the ground the surface tension is broken and the water breaks apart. As the first amount of water hits the ground it bounces outwards and upwards at an angle. It is prevented from bouncing directly upwards by the water that follows.

The water caught in the bounce, separates from the main body and creates smaller drops. As each of these smaller drops bounce they follow a parabola like a bouncing ball.

Radiating outwards from the central point of impact, as each smaller drop reaches the apex of its bounce, it slows down. As it comes out of its own apex the smaller drop then speeds up and breaks away from the middle. The water behind these smaller drops may form other drops that continue to radiate outwards or, as they run out of energy and can't complete a full arc, they may fall back on themselves.

Depending on the momentum of the water, this sequence may continue for a number of bounces, or as the drops hit the ground they run out of energy and the water flows forward over the surface.

See the drip.avi in animations002, chapter002 of the CD-ROM.

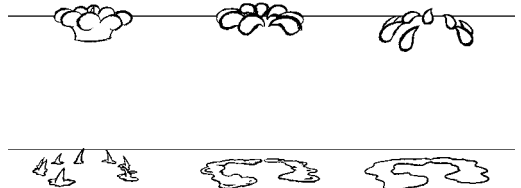
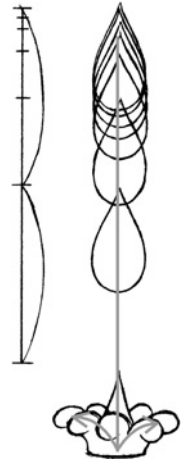

## a splash

A splash will follow the same principles of a drip, but consists of a lot more water. To help visualize this, I always think of the water bouncing off the ground as looking like sheets folding over on themselves. For the first bounce, the sheet of water remains in a mass as it radiates outwards before separating into smaller drops during further bounces or running out of energy and flowing over the ground.

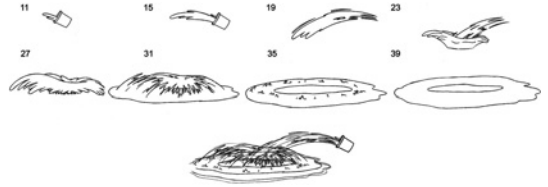

See splash.avi in animations002, chapter002 of the CD-ROM.

## object falling into water

When an object is dropped into water, the object penetrates the surface forcing up a splash from the outside edge of the object.

In the illustration you will notice that a column of water bounces up in the middle of the splash. This happens because, as the object sinks, it leaves a hollow column. The water surrounding this hollow fills in. It meets in the middle with equal force and wants to rebound. It can't bounce back because of the following water. It can't go down because the object below is in the way, so the water is propelled up. When the column of water reaches a certain height it runs out of energy and gravity takes over. The water at the very top has the most energy. As the water below runs out of energy it breaks away and falls back on itself. This leaves a blob of water floating in the air. As gravity takes over, it then

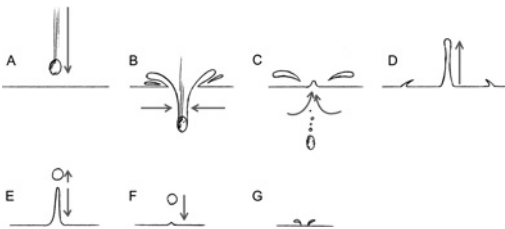
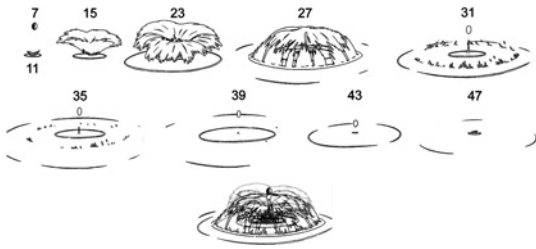

starts its descent to the water surface. It may also cause another smaller splash, when it hits the water surface. See pond\_splash.avi in animations002, chapter002 of the CD-ROM.

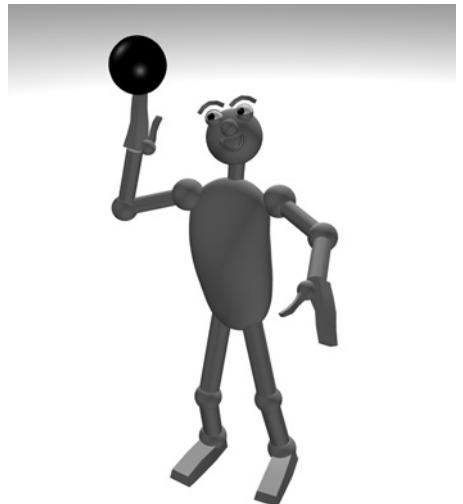

## exercises

### *the bouncy ball in 2D*

These exercises look at the principles behind the movement of inanimate objects. Using the previous examples we will animate five different balls rolling off a roof of a shed and bouncing on the ground before rolling to a stop. This exercise looks at momentum, the force of gravity and how different objects react when hitting the ground.

These objects will be:

- a bowling ball
- a soccer ball
- a beach ball
- a ping-pong ball
- a water-filled balloon

Each of the balls should be 1 cm in diameter.

### background level

First draw a shed at the side of your paper in the same position as the illustration. Draw it in black felt pen to make the lines as dark as possible, so that when you combine it with the animation it will be as clear as possible. Make the shed 5 cm wide, 5 cm tall (at the highest point) and 4 cm tall at the lowest point (these same dimensions are going to be used in your 3D-computer animation).

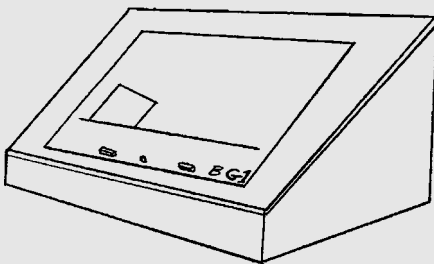
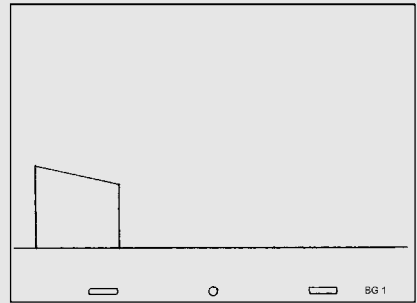

You will only need to draw this once. This is your background. When you are animating your balls, keep this background on your peg bar on the light box. Call it BG 1 by marking this in the bottom right-hand corner.

I will go through the bowling ball exercise in detail. The method is the same for all five balls and can be used as reference for the other exercises. Take a look at the *ball\_trajectories.pdf*, chapter002 of the CD-ROM.

### *animating a 2D bowling ball*

Here is the rough trajectory of a bowling ball and the key positions that should be drawn first. Note that a bowling ball will not demonstrate any squash and stretch. Keep it solid!

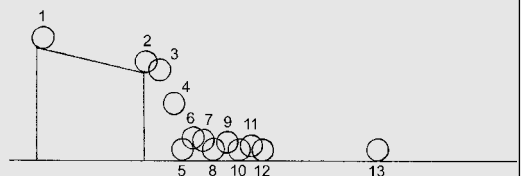

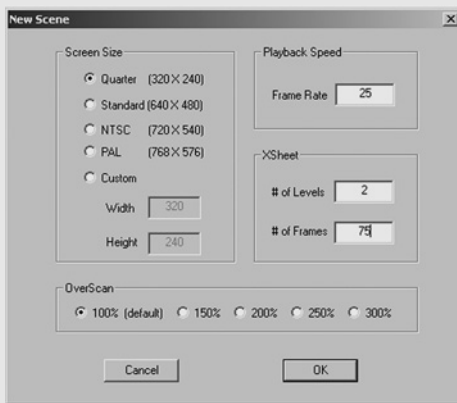

Draw each of these key positions on separate pieces of paper.

Open up DigiCel on your computer. When setting up DigiCel, have # of Frames; 75, Frame Rate; 25 and # of Levels; 1.

Place the background on the peg bar under the camera. Then lay your first drawing of the bowling ball over this. Hopefully you should be able to see the background through the animation drawing (later, when



all the in-betweens are done, we'll capture two levels, the background and the animation). Click on the Capture button.

Set the Hold box to 1, the Frame box to 1 and the Level box to 1 before you begin. Then capture your bowling ball key drawings.

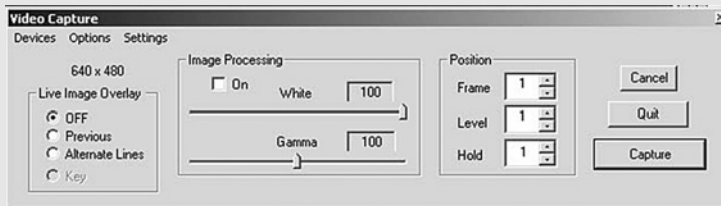

When you've finished capturing, click OK and the XSheet will look like this.

Click Play. A bit quick isn't it. So we have to give extra frames to our drawings. Experiment by prolonging the amount of frames that each of the drawings are held for (see top left illustration on p. 39).

|    | Sound | BG     |
|----|-------|--------|
| 1  |       | 1 - 1  |
| 2  |       | 1 - 2  |
| 3  |       | 1 - 3  |
| 4  |       | 1 - 4  |
| 5  |       | 1 - 5  |
| 6  |       | 1 - 6  |
| 7  |       | 1 - 7  |
| 8  |       | 1 - 8  |
| 9  |       | 1 - 9  |
| 10 |       | 1 - 10 |
| 11 |       | 1 - 11 |
| 12 |       | 1 - 12 |
| 13 |       | 1 - 13 |
| 14 |       |        |
| 15 |       |        |

As a guide arrange them on the XSheet as shown in the illustration. Note down in the 'action column' what is happening and where. If the ball hits the ground on frame 22, write 'ball hits ground' in the row that corresponds with frame 22. This is called 'slugging out' and is good to do so that you get a feel for the timing. After a while you will be able to fill in the column before you even start animating!

| XSHEET | Sound | BG   |
|--------|-------|------|
| 1      |       | 1-1  |
| 2      |       |      |
| 3      |       |      |
| 4      |       |      |
| 5      |       |      |
| 6      |       | 1-2  |
| 7      |       | 1-3  |
| 8      |       | 1-4  |
| 9      |       | 1-5  |
| 10     |       | 1-6  |
| 11     |       | 1-7  |
| 12     |       | 1-8  |
| 13     |       | 1-9  |
| 14     |       | 1-10 |
| 15     |       | 1-11 |
| 16     |       | 1-12 |
| 17     |       | 1-13 |
| 18     |       |      |
| 19     |       |      |
| 20     |       |      |
| 21     |       |      |
| 22     |       |      |
| 23     |       |      |
| 24     |       |      |
| 25     |       |      |

Play your key animation back. How does it look? If it looks like the animation in *bowlingball\_keys.avi* (chapter002, CD-ROM), you're doing OK. If not adjust the amount of frames that each of the key drawings is played for until you are happy with it. Show it to other people such as friends, loved ones or complete strangers. If they identify it as a bowling ball falling off a shed, you know you are on the right track. Here is an illustration of the bowling ball with the correct drawing numbers (the frame number that each of these balls should be captured on).

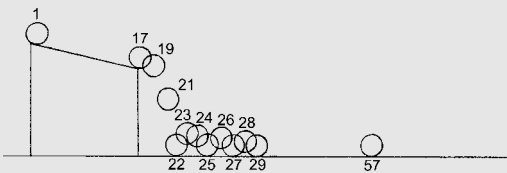

Now you have to do the in-between drawings. We will follow the same procedure as in Chapter 1 by changing the preliminary numbering sequence for the key drawings to the correct sequence including the in-betweens.

Note down the numbers for the key drawings on a paper x-sheet in column 6. In column 1, write the animation drawing numbers on every other frame.

These will be the correct

animation drawing numbers (we are going to be numbering our drawings by the frame). Transfer across the correct animation drawing numbers to the key drawings. So key drawing number 1 will now be animation drawing 1 (it corresponds with frame 1). Key drawing 2 will become animation drawing number 17 (it corresponds with frame 17), key 3 is 19, key 4 is 21, etc. Once you have re-numbered your key drawings with the correct animation number drawings, rub out the key drawing numbers on the paper x-sheet. See the illustration on p. 40.

Note that the drawings between key drawing number 4 (animation drawing 21) and key drawing number 12 (animation drawing 29) are 'singles'. This means they are shot for one frame only.

The next stage is to put timing charts on to each of your key drawings. These help you plan the positions for the in-between drawings. The timing chart is drawn at the bottom of your key between the peg bar holes. The first timing chart will be drawn on the bottom of key 1 and relates to the in-betweens from key drawing 1 (renamed animation drawing 1) and key drawing 2 (renamed animation drawing 17). As the ball rolls down the shed roof it speeds up, so in each of the following drawings, the ball should be further and further apart.

| XSHEET | Sound | BG    |
|--------|-------|-------|
| 1      |       | 1-1   |
| 2      |       |       |
| 3      |       |       |
| 4      |       |       |
| 5      |       |       |
| 6      |       |       |
| 7      |       |       |
| 8      |       |       |
| 9      |       |       |
| 10     |       |       |
| 11     |       |       |
| 12     |       |       |
| 13     |       |       |
| 14     |       |       |
| 15     |       |       |
| 16     |       |       |
| 17     |       | 1-2   |
| 18     |       |       |
| 19     |       | 1-3   |
| 20     |       |       |
| 21     |       | 1-4   |
| 22     |       | 1-5   |
| 23     |       | 1-6   |
| 24     |       | 1-7   |
| 25     |       | 1-8   |
| 26     |       | 1-9   |
| 27     |       | 1-10  |
| 28     |       | 1-11  |
| 29     |       | 1-12  |
| 30     |       |       |
| 31     |       |       |
| 32     |       |       |
| 33     |       |       |
| 34     |       |       |
| 35     |       |       |
| 36     |       |       |
| 37     |       |       |
| 38     |       |       |
| 39     |       |       |
| 40     |       |       |
| 41     |       |       |
| 42     |       |       |
| 43     |       |       |
| 44     |       |       |
| 45     |       |       |
| 46     |       |       |
| 47     |       |       |
| 48     |       |       |
| 49     |       |       |
| 50     |       |       |
| 51     |       |       |
| 52     |       |       |
| 53     |       |       |
| 54     |       |       |
| 55     |       |       |
| 56     |       |       |
| 57     |       | BG-13 |
| 58     |       |       |
| 59     |       |       |
| 60     |       |       |
| 61     |       |       |
| 62     |       |       |
| 63     |       |       |
| 64     |       |       |
| 65     |       |       |
| 66     |       |       |
| 67     |       |       |
| 68     |       |       |
| 69     |       |       |
| 70     |       |       |
| 71     |       |       |
| 72     |       |       |
| 73     |       |       |
| 74     |       |       |
| 75     |       |       |



| XSHEET | Sound | B.G. | FRM NO | 6    | 5 | 4 | 3 | 2  | 1    | B.G. |
|--------|-------|------|--------|------|---|---|---|----|------|------|
| 1      |       | 1-1  | 1      | (1)  |   |   |   |    | (1)  |      |
| 2      |       |      | 2      |      |   |   |   |    |      |      |
| 3      |       |      | 3      |      |   |   |   | 3  |      |      |
| 4      |       |      | 4      |      |   |   |   |    |      |      |
| 5      |       |      | 5      |      |   |   |   | 5  |      |      |
| 6      |       |      | 6      |      |   |   |   |    |      |      |
| 7      |       |      | 7      |      |   |   |   | 7  |      |      |
| 8      |       |      | 8      |      |   |   |   |    |      |      |
| 9      |       |      | 9      |      |   |   |   | 9  |      |      |
| 10     |       |      | 10     |      |   |   |   |    |      |      |
| 11     |       |      | 11     |      |   |   |   | 11 |      |      |
| 12     |       |      | 12     |      |   |   |   |    |      |      |
| 13     |       |      | 13     |      |   |   |   | 13 |      |      |
| 14     |       |      | 14     |      |   |   |   |    |      |      |
| 15     |       |      | 15     |      |   |   |   | 15 |      |      |
| 16     |       |      | 16     |      |   |   |   |    |      |      |
| 17     | 1-2   |      | 17     | (2)  |   |   |   |    | (17) |      |
| 18     |       |      | 18     |      |   |   |   |    |      |      |
| 19     | 1-3   |      | 19     | (3)  |   |   |   |    | (19) |      |
| 20     |       |      | 20     |      |   |   |   |    |      |      |
| 21     | 1-4   |      | 21     | (4)  |   |   |   |    | (21) |      |
| 22     | 1-5   |      | 22     | (5)  |   |   |   |    | (22) |      |
| 23     | 1-6   |      | 23     | (6)  |   |   |   |    | (23) |      |
| 24     | 1-7   |      | 24     | (7)  |   |   |   |    | (24) |      |
| 25     | 1-8   |      | 25     | (8)  |   |   |   |    | (25) |      |
| 26     | 1-9   |      | 26     | (9)  |   |   |   |    | (26) |      |
| 27     | 1-10  |      | 27     | (10) |   |   |   |    | (27) |      |
| 28     | 1-11  |      | 28     | (11) |   |   |   |    | (28) |      |
| 29     | 1-12  |      | 29     | (12) |   |   |   |    | (29) |      |
| 30     |       |      | 30     |      |   |   |   |    |      |      |
| 31     |       |      | 31     |      |   |   |   | 31 |      |      |
| 32     |       |      | 32     |      |   |   |   |    |      |      |
| 33     |       |      | 33     |      |   |   |   | 33 |      |      |
| 34     |       |      | 34     |      |   |   |   |    |      |      |
| 35     |       |      | 35     |      |   |   |   | 35 |      |      |
| 36     |       |      | 36     |      |   |   |   |    |      |      |
| 37     |       |      | 37     |      |   |   |   | 37 |      |      |
| 38     |       |      | 38     |      |   |   |   |    |      |      |
| 39     |       |      | 39     |      |   |   |   | 39 |      |      |
| 40     |       |      | 40     |      |   |   |   |    |      |      |
| 41     |       |      | 41     |      |   |   |   | 41 |      |      |
| 42     |       |      | 42     |      |   |   |   |    |      |      |
| 43     |       |      | 43     |      |   |   |   | 43 |      |      |
| 44     |       |      | 44     |      |   |   |   |    |      |      |
| 45     |       |      | 45     |      |   |   |   | 45 |      |      |
| 46     |       |      | 46     |      |   |   |   |    |      |      |
| 47     |       |      | 47     |      |   |   |   | 47 |      |      |
| 48     |       |      | 48     |      |   |   |   |    |      |      |
| 49     |       |      | 49     |      |   |   |   | 49 |      |      |
| 50     |       |      | 50     |      |   |   |   |    |      |      |
| 51     |       |      | 51     |      |   |   |   | 51 |      |      |
| 52     |       |      | 52     |      |   |   |   |    |      |      |
| 53     |       |      | 53     |      |   |   |   | 53 |      |      |
| 54     |       |      | 54     |      |   |   |   |    |      |      |
| 55     |       |      | 55     |      |   |   |   | 55 |      |      |
| 56     |       |      | 56     |      |   |   |   |    |      |      |
| 57     | 80-13 |      | 57     | (13) |   |   |   |    | (57) |      |
| 58     |       |      | 58     |      |   |   |   |    |      |      |
| 59     |       |      | 59     |      |   |   |   |    |      |      |
| 60     |       |      | 60     |      |   |   |   |    |      |      |
| 61     |       |      | 61     |      |   |   |   |    |      |      |
| 62     |       |      | 62     |      |   |   |   |    |      |      |
| 63     |       |      | 63     |      |   |   |   |    |      |      |
| 64     |       |      | 64     |      |   |   |   |    |      |      |
| 65     |       |      | 65     |      |   |   |   |    |      |      |
| 66     |       |      | 66     |      |   |   |   |    |      |      |
| 67     |       |      | 67     |      |   |   |   |    |      |      |
| 68     |       |      | 68     |      |   |   |   |    |      |      |
| 69     |       |      | 69     |      |   |   |   |    |      |      |
| 70     |       |      | 70     |      |   |   |   |    |      |      |
| 71     |       |      | 71     |      |   |   |   |    |      |      |
| 72     |       |      | 72     |      |   |   |   |    |      |      |
| 73     |       |      | 73     |      |   |   |   |    |      |      |
| 74     |       |      | 74     |      |   |   |   |    |      |      |
| 75     |       |      | 75     |      |   |   |   |    |      |      |
| 76     |       |      | 76     |      |   |   |   |    |      |      |

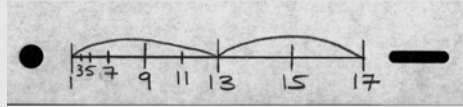

You will notice that there is a looped line between 1 and 13 and between 13 and 17. This is to indicate that drawing 13 is exactly half way between 1 and 17. The ball on drawing 13 should be half way between the ball on drawing 1 and the ball on drawing 17. Follow the timing chart – each time completing the next half-way drawing. 15 is half way between 13 and 17. Drawing 9 is half way between 1 and 13, etc.

You've done all the animation necessary between animation drawing 17 and animation drawing 29 (where the ball is bouncing on singles), so the only other timing chart to do is between animation drawing 29 (the drawing formally known as key drawing 12) and animation drawing 57 (key drawing 13).

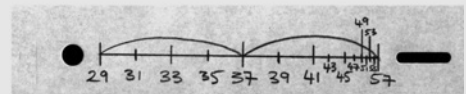
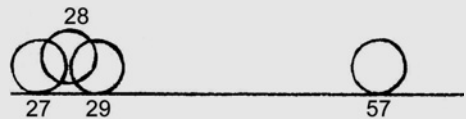

Once you've completed your in-between drawings, capture them with your line tester, following the instructions below.

When setting up DigiCel specify 2 in the # of Levels box.

Press the Capture button and the Video Capture box comes up.

- Capture the background. Change the Level box to 0 and click Capture.
- To capture the drawings on top of the background, change the Level box to 1 and change the Frame box to 1.
- Drawings 1–19 will be captured for 2 frames each. Set the Hold box to 2.
- Drawings 21–28 will be captured for 1 frame each. Set the Hold box to 1.
- Drawings 29–57 will be captured for 2 frames each. Set the Hold box to 2.

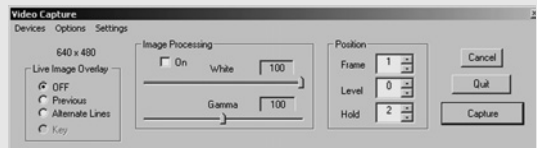
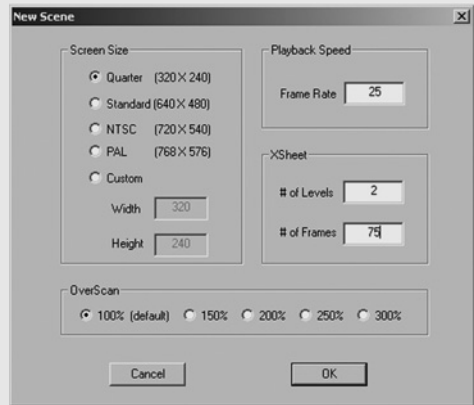

When you've finished click OK. Your x-sheet should look something like the left-hand illustration on p. 42. When you play the drawings back, your animation should look like the bowlingball\_2D.avi in animations002, chapter002 of the CD-ROM.

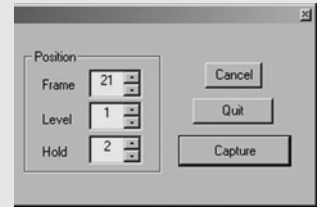
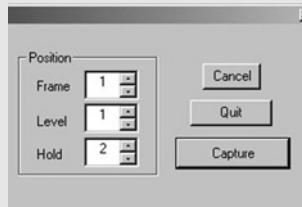

## *animating a 2D soccer ball*

The top right illustration on p. 42 shows the rough trajectory for the soccer ball and key positions. A soccer ball will undergo a certain amount of squash and stretch. As the ball hits the ground it squashes. As it flies through the air, at the fastest point of each arc, it stretches.

Draw the 12 key positions of the soccer ball and capture them. Number each key by the drawing: 1, 2, 3, 4, etc. The sequence will be 120 frames long (set up DigiCel to be # of Frames; 120, Frame Rate; 25 and # of Levels; 2). Play the keys back and adjust the frames until you are happy with the timing of the sequence (left click and hold down the Alt key while dragging down). Use the right-hand illustrations on p. 42 for reference. Check out soccerball\_keys in animations002, chapter002 of the CD-ROM.

Once you are happy with the sequence, re-number the key drawings by the frame number. You then know how many in-between drawings are needed. Mark them up on a paper x-sheet (see the top illustrations on p. 43).

| xSheet |  |      | FRM NO | 6 | 5 | 4 | 3 | 2 | 1    | B.G. |
|--------|--|------|--------|---|---|---|---|---|------|------|
| 1      |  | 1-1  |        |   |   |   |   |   | (1)  | B.G. |
| 2      |  |      |        |   |   |   |   |   |      |      |
| 3      |  | 1-3  |        |   |   |   |   |   | 3    |      |
| 4      |  |      |        |   |   |   |   |   |      |      |
| 5      |  | 1-5  |        |   |   |   |   |   | 5    |      |
| 6      |  |      |        |   |   |   |   |   |      |      |
| 7      |  | 1-7  |        |   |   |   |   |   | 7    |      |
| 8      |  |      |        |   |   |   |   |   |      |      |
| 9      |  | 1-9  |        |   |   |   |   |   | 9    |      |
| 10     |  |      |        |   |   |   |   |   |      |      |
| 11     |  | 1-11 |        |   |   |   |   |   | 11   |      |
| 12     |  |      |        |   |   |   |   |   |      |      |
| 13     |  | 1-13 |        |   |   |   |   |   | 13   |      |
| 14     |  |      |        |   |   |   |   |   |      |      |
| 15     |  | 1-15 |        |   |   |   |   |   | 15   |      |
| 16     |  |      |        |   |   |   |   |   |      |      |
| 17     |  | 1-17 |        |   |   |   |   |   | (17) |      |
| 18     |  |      |        |   |   |   |   |   |      |      |
| 19     |  | 1-19 |        |   |   |   |   |   | (19) |      |
| 20     |  |      |        |   |   |   |   |   |      |      |
| 21     |  | 1-21 |        |   |   |   |   |   | (21) |      |
| 22     |  | 1-22 |        |   |   |   |   |   | (22) |      |
| 23     |  | 1-23 |        |   |   |   |   |   | (23) |      |
| 24     |  | 1-24 |        |   |   |   |   |   | (24) |      |
| 25     |  | 1-25 |        |   |   |   |   |   | (25) |      |
| 26     |  | 1-26 |        |   |   |   |   |   | (26) |      |
| 27     |  | 1-27 |        |   |   |   |   |   | (27) |      |
| 28     |  | 1-28 |        |   |   |   |   |   | (28) |      |
| 29     |  | 1-29 |        |   |   |   |   |   | (29) |      |
| 30     |  |      |        |   |   |   |   |   |      |      |
| 31     |  | 1-31 |        |   |   |   |   |   | 31   |      |
| 32     |  |      |        |   |   |   |   |   |      |      |
| 33     |  | 1-33 |        |   |   |   |   |   | 33   |      |
| 34     |  |      |        |   |   |   |   |   |      |      |
| 35     |  | 1-35 |        |   |   |   |   |   | 35   |      |
| 36     |  |      |        |   |   |   |   |   |      |      |
| 37     |  | 1-37 |        |   |   |   |   |   | 37   |      |
| 38     |  |      |        |   |   |   |   |   |      |      |
| 39     |  | 1-39 |        |   |   |   |   |   | 39   |      |
| 40     |  |      |        |   |   |   |   |   |      |      |
| 41     |  | 1-41 |        |   |   |   |   |   | 41   |      |
| 42     |  |      |        |   |   |   |   |   |      |      |
| 43     |  | 1-43 |        |   |   |   |   |   | 43   |      |
| 44     |  |      |        |   |   |   |   |   |      |      |
| 45     |  | 1-45 |        |   |   |   |   |   | 45   |      |
| 46     |  |      |        |   |   |   |   |   |      |      |
| 47     |  | 1-47 |        |   |   |   |   |   | 47   |      |
| 48     |  |      |        |   |   |   |   |   |      |      |
| 49     |  | 1-49 |        |   |   |   |   |   | 49   |      |
| 50     |  |      |        |   |   |   |   |   |      |      |
| 51     |  | 1-51 |        |   |   |   |   |   | 51   |      |
| 52     |  |      |        |   |   |   |   |   |      |      |
| 53     |  | 1-53 |        |   |   |   |   |   | 53   |      |
| 54     |  |      |        |   |   |   |   |   |      |      |
| 55     |  | 1-55 |        |   |   |   |   |   | 55   |      |
| 56     |  |      |        |   |   |   |   |   |      |      |
| 57     |  | 1-57 |        |   |   |   |   |   | (57) |      |
| 58     |  |      |        |   |   |   |   |   |      |      |
| 59     |  |      |        |   |   |   |   |   |      |      |
| 60     |  |      |        |   |   |   |   |   |      |      |
| 61     |  |      |        |   |   |   |   |   |      |      |
| 62     |  |      |        |   |   |   |   |   |      |      |
| 63     |  |      |        |   |   |   |   |   |      |      |
| 64     |  |      |        |   |   |   |   |   |      |      |
| 65     |  |      |        |   |   |   |   |   |      |      |
| 66     |  |      |        |   |   |   |   |   |      |      |
| 67     |  |      |        |   |   |   |   |   |      |      |
| 68     |  |      |        |   |   |   |   |   |      |      |
| 69     |  |      |        |   |   |   |   |   |      |      |
| 70     |  |      |        |   |   |   |   |   |      |      |
| 71     |  |      |        |   |   |   |   |   |      |      |
| 72     |  |      |        |   |   |   |   |   |      |      |
| 73     |  |      |        |   |   |   |   |   |      |      |
| 74     |  |      |        |   |   |   |   |   |      |      |
| 75     |  |      |        |   |   |   |   |   |      |      |
| 76     |  |      |        |   |   |   |   |   |      |      |

Bowling ball x-sheet with original key drawings erased from column 6 and lines added in columns B.G. and 1.



| xSheet |      | xSheet |      | xSheet |      |
|--------|------|--------|------|--------|------|
| Sound  | B.G. | Sound  | B.G. | Sound  | B.G. |
| 1      | 1-1  | 27     | 1-3  | 53     |      |
| 2      |      | 28     |      | 54     |      |
| 3      |      | 29     |      | 55     |      |
| 4      |      | 30     |      | 56     |      |
| 5      |      | 31     |      | 57     | 1-8  |
| 6      |      | 32     |      | 58     |      |
| 7      |      | 33     | 1-4  | 59     |      |
| 8      |      | 34     |      | 60     |      |
| 9      |      | 35     |      | 61     |      |
| 10     |      | 36     |      | 62     | 1-9  |
| 11     |      | 37     |      | 63     |      |
| 12     |      | 38     | 1-5  | 64     |      |
| 13     |      | 39     |      | 65     |      |
| 14     |      | 40     |      | 66     | 1-10 |
| 15     |      | 41     |      | 67     |      |
| 16     |      | 42     |      | 68     |      |
| 17     |      | 43     |      | 69     | 1-10 |
| 18     |      | 44     |      | 70     |      |
| 19     |      | 45     | 1-6  | 71     |      |
| 20     |      | 46     |      | 72     |      |
| 21     | 1-2  | 47     |      | 73     |      |
| 22     |      | 48     |      | 74     | 1-11 |
| 23     |      | 49     |      | 75     |      |
| 24     |      | 50     |      | 76     |      |
| 25     |      | 51     |      | 77     |      |
| 26     |      | 52     | 1-7  | 78     |      |

| xSheet |      | xSheet |      |
|--------|------|--------|------|
| Sound  | B.G. | Sound  | B.G. |
| 79     |      | 96     |      |
| 80     |      | 97     |      |
| 81     |      | 98     |      |
| 82     |      | 99     |      |
| 83     |      | 100    |      |
| 84     |      | 101    |      |
| 85     |      | 102    |      |
| 86     |      | 103    |      |
| 87     |      | 104    |      |
| 88     |      | 105    |      |
| 89     |      | 106    |      |
| 90     |      | 107    |      |
| 91     |      | 108    |      |
| 92     |      | 109    |      |
| 93     |      | 110    |      |
| 94     |      | 111    | 1-12 |
| 95     |      | 112    |      |
| 96     |      | 113    |      |
| 97     |      | 114    |      |
| 98     |      | 115    |      |
| 99     |      | 116    |      |
| 100    |      | 117    |      |
| 101    |      | 118    |      |
| 102    |      | 119    |      |
| 103    |      | 120    |      |
| 104    |      |        |      |

Work out the timing charts for each key drawing. Use the left-hand illustration on p. 43 for reference. Complete the in-betweens. All the drawings in this piece of animation are on twos.

When you have drawn all the in-betweens, capture them and play them back. If your animation looks

like soccerball\_2D.avi in animations002, chapter002 of the CD-ROM, well done. If not, try to find where you've gone wrong. For example, if the ball spends too much time in the air, take a drawing out, or hold one of the drawings for a single frame rather than a double. Don't be afraid to experiment.

| LEVELS: |   |   |   |   |   |   |       |
|---------|---|---|---|---|---|---|-------|
| FRM NO  | 6 | 5 | 4 | 3 | 2 | 1 | B.G   |
| 1       |   |   |   |   |   |   | B.G.1 |
| 2       |   |   |   |   |   |   |       |
| 3       |   |   |   |   |   |   |       |
| 4       |   |   |   |   |   |   |       |
| 5       |   |   |   |   |   |   |       |
| 6       |   |   |   |   |   |   |       |
| 7       |   |   |   |   |   |   |       |
| 8       |   |   |   |   |   |   |       |
| 9       |   |   |   |   |   |   |       |
| 10      |   |   |   |   |   |   |       |
| 11      |   |   |   |   |   |   |       |
| 12      |   |   |   |   |   |   |       |
| 13      |   |   |   |   |   |   |       |
| 14      |   |   |   |   |   |   |       |
| 15      |   |   |   |   |   |   |       |
| 16      |   |   |   |   |   |   |       |
| 17      |   |   |   |   |   |   |       |
| 18      |   |   |   |   |   |   |       |
| 19      |   |   |   |   |   |   |       |
| 20      |   |   |   |   |   |   |       |
| 21      |   |   |   |   |   |   |       |
| 22      |   |   |   |   |   |   |       |
| 23      |   |   |   |   |   |   |       |
| 24      |   |   |   |   |   |   |       |
| 25      |   |   |   |   |   |   |       |
| 26      |   |   |   |   |   |   |       |
| 27      |   |   |   |   |   |   |       |
| 28      |   |   |   |   |   |   |       |
| 29      |   |   |   |   |   |   |       |
| 30      |   |   |   |   |   |   |       |
| 31      |   |   |   |   |   |   |       |
| 32      |   |   |   |   |   |   |       |
| 33      |   |   |   |   |   |   |       |
| 34      |   |   |   |   |   |   |       |
| 35      |   |   |   |   |   |   |       |
| 36      |   |   |   |   |   |   |       |
| 37      |   |   |   |   |   |   |       |
| 38      |   |   |   |   |   |   |       |
| 39      |   |   |   |   |   |   |       |
| 40      |   |   |   |   |   |   |       |
| 41      |   |   |   |   |   |   |       |
| 42      |   |   |   |   |   |   |       |
| 43      |   |   |   |   |   |   |       |
| 44      |   |   |   |   |   |   |       |
| 45      |   |   |   |   |   |   |       |
| 46      |   |   |   |   |   |   |       |
| 47      |   |   |   |   |   |   |       |
| 48      |   |   |   |   |   |   |       |
| 49      |   |   |   |   |   |   |       |
| 50      |   |   |   |   |   |   |       |

| LEVELS: |   |   |   |   |   |   |       |
|---------|---|---|---|---|---|---|-------|
| FRM NO  | 6 | 5 | 4 | 3 | 2 | 1 | B.G   |
| 51      |   |   |   |   |   |   | B.G.1 |
| 52      |   |   |   |   |   |   |       |
| 53      |   |   |   |   |   |   |       |
| 54      |   |   |   |   |   |   |       |
| 55      |   |   |   |   |   |   |       |
| 56      |   |   |   |   |   |   |       |
| 57      |   |   |   |   |   |   |       |
| 58      |   |   |   |   |   |   |       |
| 59      |   |   |   |   |   |   |       |
| 60      |   |   |   |   |   |   |       |
| 61      |   |   |   |   |   |   |       |
| 62      |   |   |   |   |   |   |       |
| 63      |   |   |   |   |   |   |       |
| 64      |   |   |   |   |   |   |       |
| 65      |   |   |   |   |   |   |       |
| 66      |   |   |   |   |   |   |       |
| 67      |   |   |   |   |   |   |       |
| 68      |   |   |   |   |   |   |       |
| 69      |   |   |   |   |   |   |       |
| 70      |   |   |   |   |   |   |       |
| 71      |   |   |   |   |   |   |       |
| 72      |   |   |   |   |   |   |       |
| 73      |   |   |   |   |   |   |       |
| 74      |   |   |   |   |   |   |       |
| 75      |   |   |   |   |   |   |       |
| 76      |   |   |   |   |   |   |       |
| 77      |   |   |   |   |   |   |       |
| 78      |   |   |   |   |   |   |       |
| 79      |   |   |   |   |   |   |       |
| 80      |   |   |   |   |   |   |       |
| 81      |   |   |   |   |   |   |       |
| 82      |   |   |   |   |   |   |       |
| 83      |   |   |   |   |   |   |       |
| 84      |   |   |   |   |   |   |       |
| 85      |   |   |   |   |   |   |       |
| 86      |   |   |   |   |   |   |       |
| 87      |   |   |   |   |   |   |       |
| 88      |   |   |   |   |   |   |       |
| 89      |   |   |   |   |   |   |       |
| 90      |   |   |   |   |   |   |       |
| 91      |   |   |   |   |   |   |       |
| 92      |   |   |   |   |   |   |       |
| 93      |   |   |   |   |   |   |       |
| 94      |   |   |   |   |   |   |       |
| 95      |   |   |   |   |   |   |       |
| 96      |   |   |   |   |   |   |       |
| 97      |   |   |   |   |   |   |       |
| 98      |   |   |   |   |   |   |       |
| 99      |   |   |   |   |   |   |       |
| 100     |   |   |   |   |   |   |       |

| LEVELS: |   |   |   |   |   |   |       |
|---------|---|---|---|---|---|---|-------|
| FRM NO  | 6 | 5 | 4 | 3 | 2 | 1 | B.G   |
| 101     |   |   |   |   |   |   | B.G.1 |
| 102     |   |   |   |   |   |   |       |
| 103     |   |   |   |   |   |   |       |
| 104     |   |   |   |   |   |   |       |
| 105     |   |   |   |   |   |   |       |
| 106     |   |   |   |   |   |   |       |
| 107     |   |   |   |   |   |   |       |
| 108     |   |   |   |   |   |   |       |
| 109     |   |   |   |   |   |   |       |
| 110     |   |   |   |   |   |   |       |
| 111     |   |   |   |   |   |   |       |
| 112     |   |   |   |   |   |   |       |
| 113     |   |   |   |   |   |   |       |
| 114     |   |   |   |   |   |   |       |
| 115     |   |   |   |   |   |   |       |
| 116     |   |   |   |   |   |   |       |
| 117     |   |   |   |   |   |   |       |
| 118     |   |   |   |   |   |   |       |
| 119     |   |   |   |   |   |   |       |
| 120     |   |   |   |   |   |   |       |

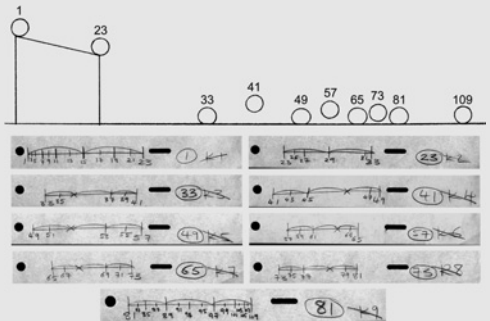
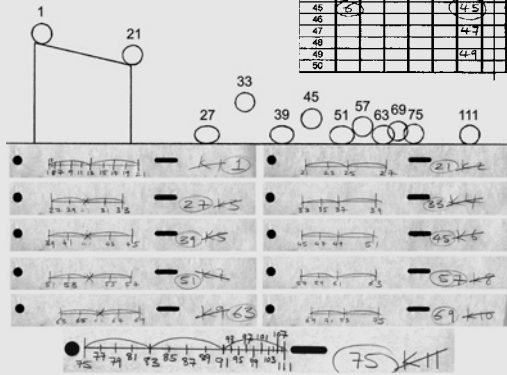

### animating a 2D beach ball

The beach ball sequence will be 120 frames long (set up DigiCel to be # of Frames; 120, Frame Rate; 25 and # of Levels; 2).

Use the same procedure as for the bowling ball and soccer ball. This time experiment with the timing. A beach ball will travel more slowly through the air than a football. It might roll slightly as it bounces on the ground and not bounce as high. It will crumple at the bottom when it hits the ground rather than squash like a soccer ball. Have a look at beachball\_keys.avi and beachball\_2D.avi in animations 002, chapter002 of the CD-ROM. As the beach ball bounces there will be an in-between drawing just before it touches the ground. This slows the beach ball down. The reason we do this is to emphasize the lightness of the beach ball, suggesting that the air above the ground gives a small amount of resistance to such a light ball. See the illustration at the top of p. 44.

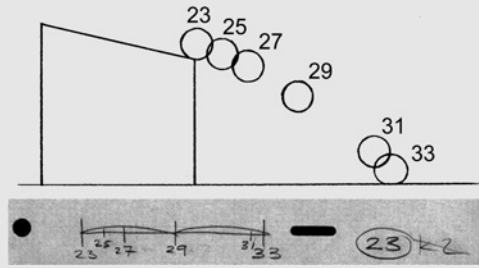

### animating a 2D ping-pong ball

A ping-pong ball will bounce quite high with fairly short distances between the apex of each bounce. It will not squash or stretch at all. The upwards bounce is quite quick. When it reaches the apex it slows, before almost floating down to hit the ground. Adjust your in-betweens accordingly. The illustration shows the trajectory of a ping-pong ball. Once it hits the ground it bounces very quickly. To show this, the drawings between 19 and 56 will be on singles.

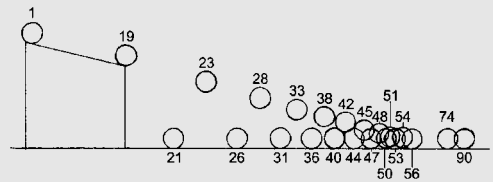

Use the same procedure as for the bowling ball and the soccer ball. The ping-pong ball sequence will be 100 frames long. Set up DigiCel to be # of Frames; 100, Frame Rate; 25 and # of Levels; 2.

Have a look at ping-pongball\_keys.avi and ping-pongball\_2D.avi in animations002, chapter002 of the CD-ROM.

### animating a 2D water-filled balloon

This is probably the most difficult sequence to animate, but is also the most fun to watch when it's working well.

Work out the basic trajectory. Think of the water flowing around the inside of the balloon as it moves, pushing the balloon forward.

The sequence will be 75 frames long. Set up DigiCel to be # of Frames; 75, Frame Rate; 25 and # of Levels; 2.

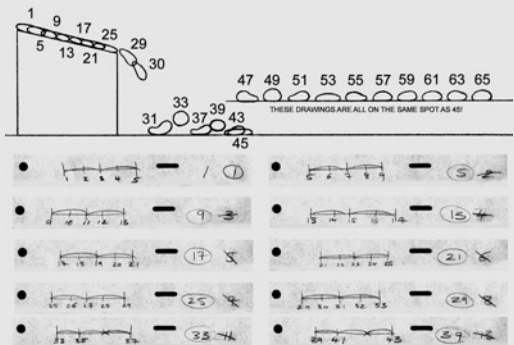

Start with the basic key positions of the balloon rolling down the shed roof. The in-between drawings of this sequence should be on singles. The illustration below shows the in-betweens from key 1 to key 5. The rest of the sequence of the balloon rolling down the roof will follow this pattern.

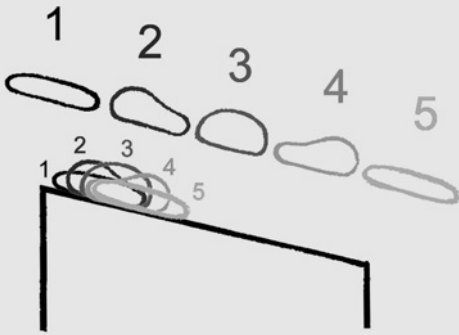

Try to make sure the balloon doesn't slide down the roof. Most forward movement occurs at the point at which the balloon is most stretched. When stationary, the water rotating inside the balloon stretches the rubber slightly backwards, upwards, then ahead. As the water inside the balloon moves forward it stretches the balloon and pulls it onward.

Have a look at `waterballoon_keys.avi` in `animations002`, chapter002 of the CD-ROM.

The water-filled balloon will fall quickly when it leaves the edge of the roof because it is very heavy. When it lands it will squash slightly more on one side than the other because of the slight angle at which it leaves the roof.

When you have animated the full sequence capture the drawings and the background and see how it looks.

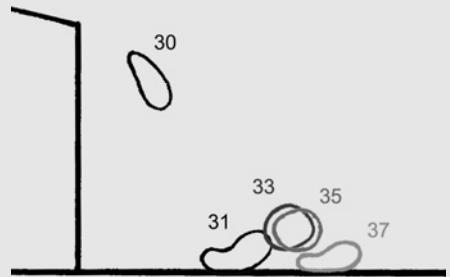

Take a look at `waterballoon_2D.avi` in `animations002`, chapter002 of the CD-ROM.

When you are happy with the five different sequences – and it is easy to identify what sort of balls they are – you are ready to do them all again in 3D!

### *the bouncy ball in 3D*

To animate the five different balls in 3D we will follow a similar approach to the exercises in 2D. First we need to make a background. This consists of a cube that has been given a sloping top. It is built to the same proportions as the shed in our 2D background (5 units  $\times$  5 units  $\times$  4 units). We also need to make a floor for the ball to bounce on. This consists of a grid that is the same width as our shed and is long enough to fit all of our ball bounces on (5 units  $\times$  40 units). This only has to be built once. It can be re-used for each ball we animate.

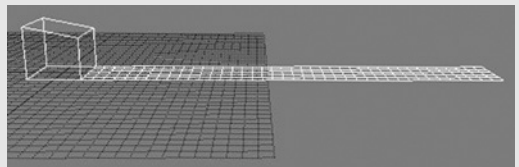

Then we need to make our balls. These will all be the same size! We want an audience to be able to tell what sort of ball they are from their movement rather than their size. The balls will always be  $1/5$  the size of the width of the shed.

Each of the balls will have to be constructed with a 'hierarchy'. A hierarchy is an abstract graphical interpretation of how a model is constructed. It will consist of a 'parent' which

could then be linked to any number of 'children'. Let's say we have two objects on screen, a big cube and a smaller cube. They will be linked together, in a hierarchy. The large cube is the parent, the smaller cube is the child. When you select the large cube (the parent) and move it, the small cube (the child) will move with it. But when you select and move the small cube (the child) it will move on its own, leaving the large cube (the parent) behind.

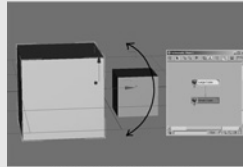
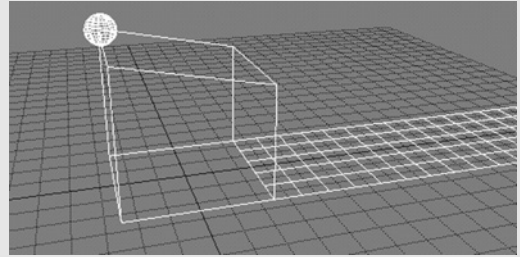

Select Large Cube and rotate...

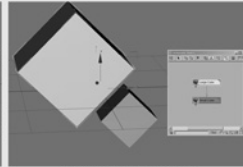

...and Small Cube will follow...

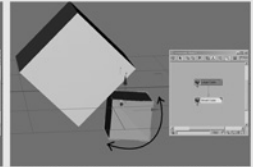

...but the Small Cube will rotate independently

Movement given to the parent will affect all of the children, but movement given to a child will work independently of the parent.

The ball hierarchy will consist of three parts, a parent, a child and a child of the child. The parent and the first child will be invisible objects the second child (grandchild?) will be the ball. These invisible objects are devices that do not render in the final version of your animation. (They are called 'Point Helpers' in 3D Studio Max, 'Locators' in Maya and 'Nulls' in LightWave and Soft|Image XSI.) The first two parts of the hierarchy will have a different 'movement' ascribed to them. The parent object will deal with the movement (or translation) of the ball and the first child will deal with the rotation. In order to save confusion it's a good idea to rename these invisible objects 'movement' and 'rotation'.

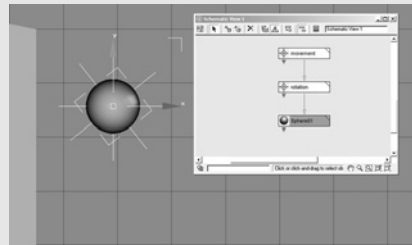

First we work out the key positions of the movement (or translation) of the ball and setting keys on the movement part of the hierarchy (this will take the other parts of the hierarchy with it). We do this by following the key positions of our drawn animation. The first key position will be at the top of the shed. This will be on frame 1. So select the movement part of the hierarchy and set key positions on this. The second key position will be just as the ball reaches the end of the shed roof. The frame number of this key position depends on which ball you are animating (with the bowling ball it's frame 17). The key position where the ball leaves the roof is on frame 19. The remaining key positions are worked out by measuring the height and the distance travelled by each of the drawn key balls, and then

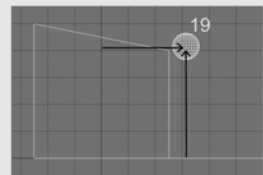
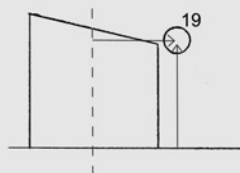

putting the ball, in the 3D-computer animation program, in the same position and at the same frame number as the drawn key ball. Take all your measurements from the centre of the block for the distance and the height of the ball above the ground.

Don't be afraid to draw on the monitor screen with a 'chinagraph' pencil (although I accept no responsibility for any damage that you may do; don't draw on a LCD screen). Draw the rough positions onto the screen of where the ball looks like it should go according to your drawn keys and then position the 3D ball underneath.

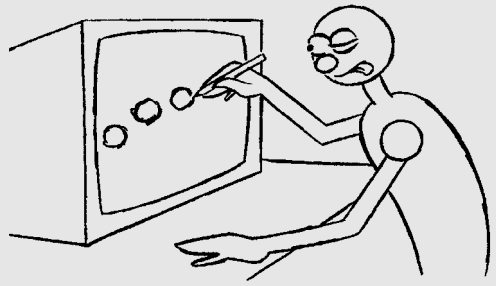

Once the 'movement' key positions are in place the computer will do the in-betweens for us. As we saw in Chapter 1, the in-betweening that the computer does will not be correct. We have to tell it where to put the in-between balls. We do this either by putting in all the in-between balls ourselves or by manipulating the animation curves, as in Chapter 1.

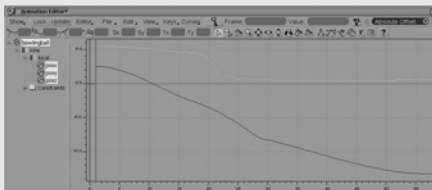

SoftImage XSI Animation Editor

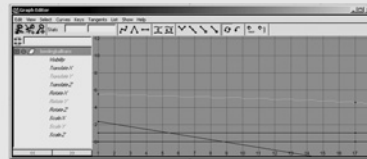

Maya Graph Editor.

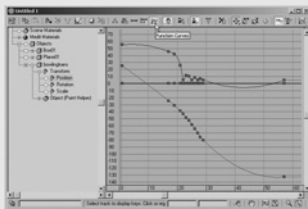

3DS Max Track View.

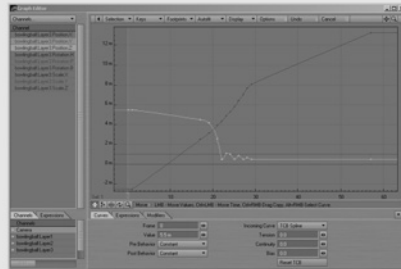

LightWave Graph Editor.

Once the movement is done we can go back over our animation and set keys for rotation on the rotation part of the hierarchy. Select the rotation part of the hierarchy and set a key at the very start of the piece of animation. Work out how much the ball will rotate over the length of the scene by measuring the distance travelled in relation to the circumference of the ball. Then, go to the very end of the scene, rotate the ball by the correct amount and then adjust the curves to make it look right.

You will find how to animate each of the five sorts of balls in more detail in chapter002 of the CD-ROM in .pdf files that relate to each of the 3D animation programs that are covered in this book. The .pdf files are called 3DS\_Max\_bouncy\_balls.pdf, Maya\_bouncy\_balls.pdf, LightWave\_bouncy\_balls.pdf and XSI\_bouncy\_balls.pdf.



## chapter 3

# the construction of a simple character, its articulation and balance

### chapter summary

- *basic human anatomy*
  - the spine*
  - the rib cage*
  - the pelvic girdle*
  - the skull*
  - the shoulders*
- *joints*
  - plane joints*
  - pivot joints*
  - hinge joints*
  - ball-and-socket joints*
  - saddle joints*
  - condyloid joints*
- *moving in arcs*
- *how to design a basic human character*
  - complexity*
  - the graphic nature of characters*
  - strong silhouettes*
  - weight and balance*
- *how to design a 3D character*

- *planning a scene*
- *animating your characters*
- *exercises*
  - the lift in 2D*
  - the lift in 3D*
  - the push in 2D*
  - the push in 3D*
  - the pull in 2D*
  - the pull in 3D*
- *how to build and rig a simple 3D character*
  - skin and bones*
  - child of the joint*
  - first get your body parts*
  - putting bones in your man*
  - setting up eye controls*
  - setting up the legs*

Animating inanimate objects like bouncy balls gives you an idea of weight, timing, spacing and squash and stretch. However, they are not the most interesting things to animate. During this chapter, we will animate something with life, something that initiates movement and has forces imposed upon it. The human character.

Our first task is to design our character. Before doing this we need a basic understanding of human anatomy. I will go through the construction of the skeleton and types of joints. As well as looking at the structure of these – I will also explain how they move and the importance of arcs when animating.

## **basic human anatomy**

A whole book could be written on human and animal anatomy, so I'm going to stick to the absolute minimum that we need to know.

Let's start with the main part of the human skeleton, the spine.

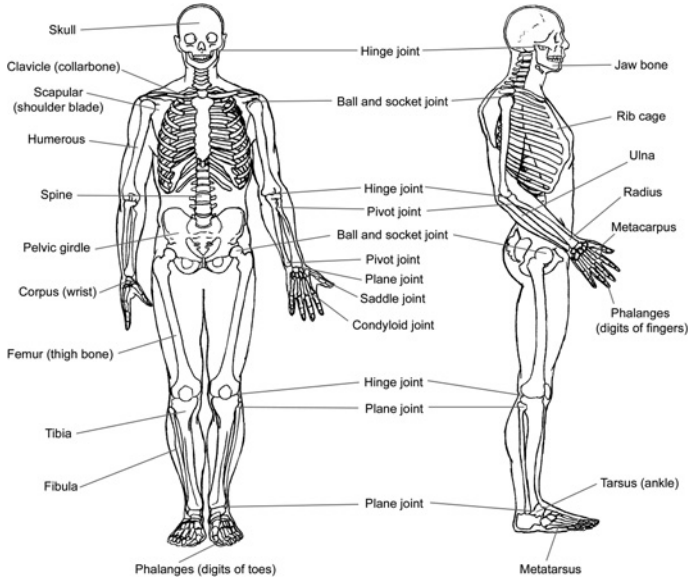

## *the spine*

At the centre of the human skeleton is the S shaped spine. This is made up of 24 individual bones, called vertebra. These are linked by discs of cartilage and have a limited amount of angular and twisting movement. This combination gives the spine great flexibility allowing forward and backward and side-to-side movement and a degree of twisting.

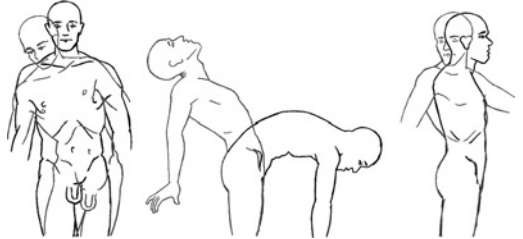

At the top of the spine are the seven vertebrae that make up the neck.

## *the rib cage*

Attached to the next twelve vertebrae are 24 ribs (two per vertebra) which constitute the rib cage. The role of the rib cage is to protect the heart, lungs and internal organs. At the bottom of the rib cage is the diaphragm; this in conjunction with the rib cage controls the breathing. The rib cage restricts the bending and twisting movement of the 12 vertebrae that the ribs are attached to. The lower five vertebrae make up the lower spine. Most of the twisting and bending of the spine during the body's movement occurs between these five vertebrae.

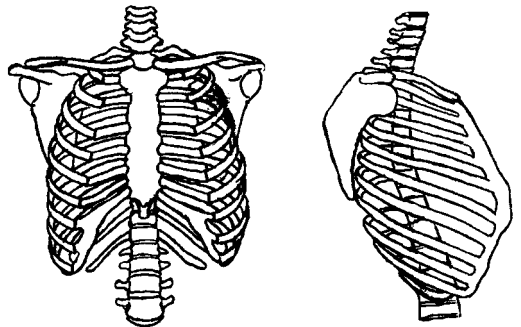

## *the pelvic girdle*

At the base of the spine is the pelvic girdle. This solid set of bones plays a

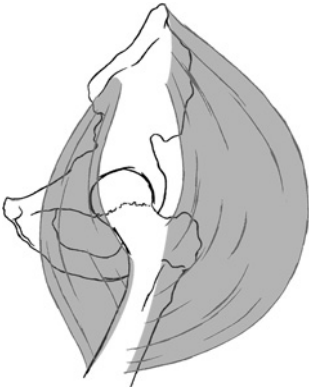

role in keeping us upright. Attached by ball and socket joints are the two femurs of the upper legs. The largest muscle in the body (the gluteus maximus) is attached to the upper thighbone (the femur) at one end and the pelvic girdle at the other end. This muscle is used to hold the body upright when stationary and moves the femur during walking. It is used when picking things up and jumping. It also helps with the balance of the body.



## *the skull*

At the top of the spine is the skull. Attached to the skull is the jaw bone, this hinges from the point at which it meets the skull. It can have an up-and-down and a side-to-side movement.

Between the skull and the rib cage is the neck. This also displays a large amount of twisting and bending, giving about 90 degrees backwards and forwards.

It also gives about 180 degrees of twist.

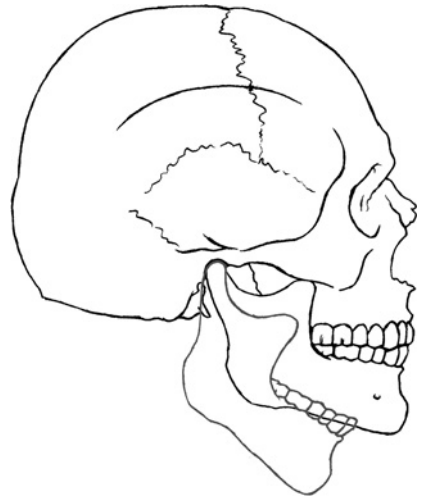

## *the shoulders*

At the top of the rib cage, are the two collarbones (clavicles) at the front and two shoulder blades (scapulars) at the back. Each of the collarbones is connected to the front of the rib cage at the inner end and to the shoulder blades at the outer end. When viewed from the top, these form a triangle, which holds the upper arm (humerus) in place, at a ball-and-socket joint.

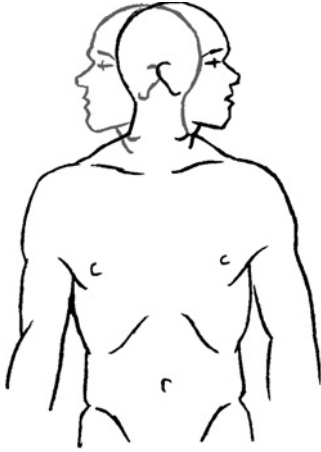

The shoulder blades are almost 'free floating' and can move in a number of directions. Up and down, inward so that they are almost touching at the spine and outwards to the edge of the rib cage. The main things restricting their movement are the collarbones.

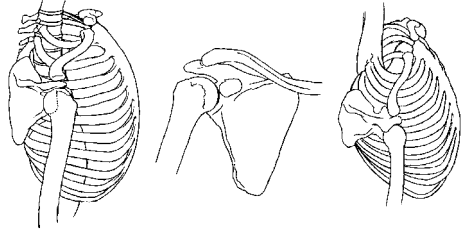

The movement of the shoulder blades affects the position of the arms. For example, by raising the shoulder blades, the arms raise and give the body the appearance of a shrug. When picking up a heavy object the shoulder blades and collarbones will be lowered, lowering the position of the arm. Much of the character and mood of a person is conveyed by the positions of the shoulders. See *shoulderjoint.avi* in chapter003 of the CD-ROM.

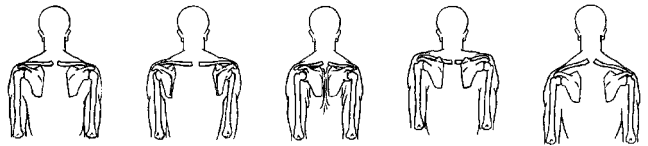
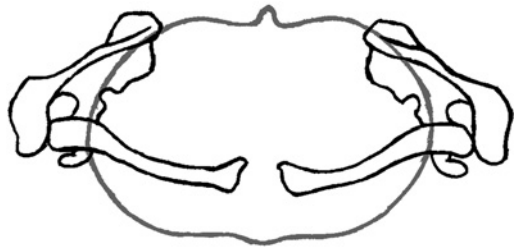

## joints

The limbs of the skeleton are linked by joints, of which there are six types. These are:

- plane joints
- pivot joints
- hinge joints
- ball-and-socket joints
- saddle joints
- condyloid joints

Understanding how these joints work gives us a clue to understanding movement.

### *plane joints*

The surfaces that meet at a plane joint are flat or slightly curved. This allows only a small amount of movement,

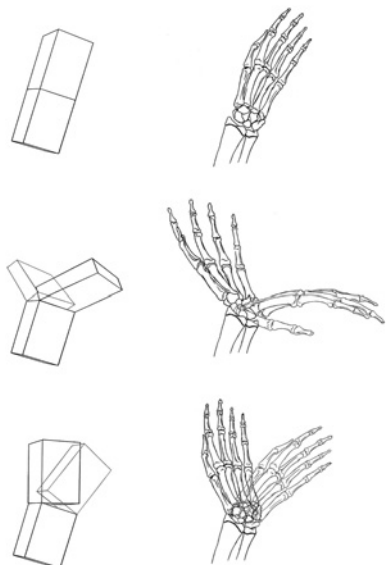

about 90 degrees backwards and forwards and approximately 45 degrees from side to side. Examples are the wrist and ankle. See `planejoint.avi` in chapter003 of the CD-ROM.

### *pivot joints*

This consists of a cylindrical bone twisting within a complete or partial ring. The best example of this is the joint just below the wrist between the two bones of the forearm, the radius and the ulna. This movement combined with the plane joint of the wrist produces the very expressive movement of the wrists. See `pivotjoint.avi` in chapter003 of the CD-ROM.

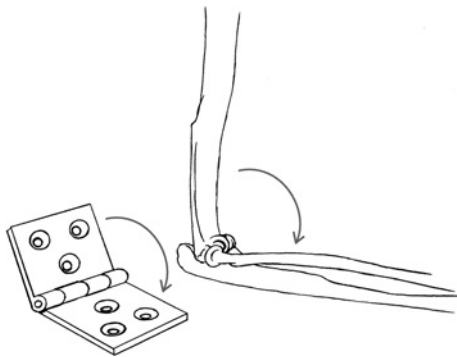
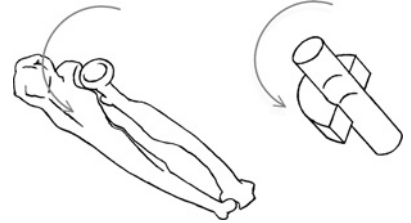

### *hinge joints*

The hinge joint, as its name suggests, moves in one plane, like a hinge. The end of one bone ends in a cylinder, the other in a cylindrical excavation. Depending on the joint, it will give up to 160 degrees of movement. Examples include; knees, elbows, fingers and toes (excluding the first knuckle). See `hingejoint.avi` in chapter003 of the CD-ROM.

### *ball-and-socket joints*

The ball-and-socket joint allows a huge amount of circular movement in most directions.

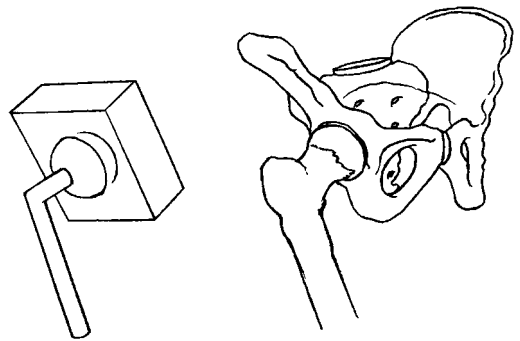
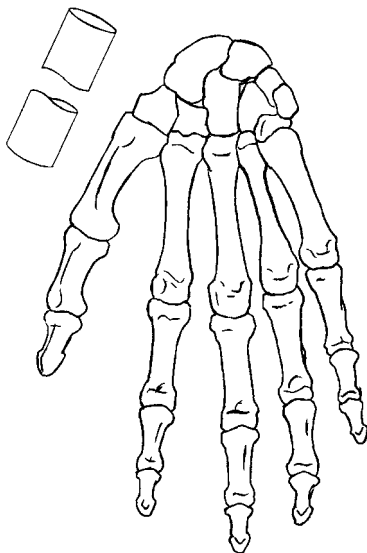

A sphere at the end of one bone fits into a spherical excavation at the end of the other bone. Examples include the hip joint and the shoulder joint. See `ballandsocketjoint.avi` in chapter003 of the CD-ROM.

### *saddle joints*

This is a joint that is almost a combination of a hinge joint and a ball-and-socket joint. It's a hinge joint that allows for a certain amount of side-to-side movement. The main example is the joint between the hand and the thumb. See `saddlejoint.avi` in chapter003 of the CD-ROM.

## condyloid joints

A bit like the saddle joint but with more circular movement. Examples of this joint are the first row of knuckles between the fingers and the hand. See *condyloidjoint.avi* in chapter003 of the CD-ROM.

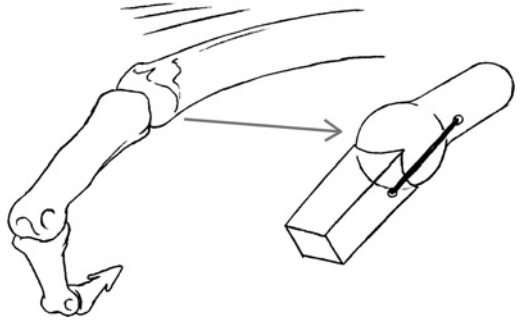

## moving in arcs

Most movements undertaken by the human body will describe arcs. For example if you keep your arm straight and raise it above your head your hand will move in an arc.

When we watch someone walking, we are aware of how the joints of the body are moving. Subconsciously we see how they move in arcs in relation to each other and from this we deduce that this creature is a human being. Anything that doesn't move in this way will look strange.

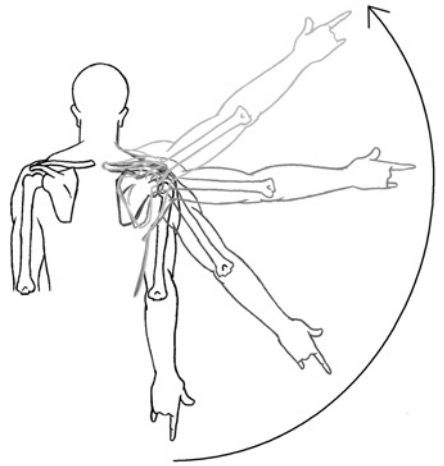

As an experiment, I built a human character in 3D. Rather than having a skin, I put a white ball at each of the joints. Set against a black background, all you see is a collection of white spheres. I then animated a basic walk cycle, with the character walking on the spot. When playing all you can see are some white balls moving through space. Despite the abstract nature of the sequence, it is surprisingly easy to work out that it is a human character walking on the spot. This emphasizes how important it is to have one foot in reality when moving human characters. Take a look at *arcs.avi* in chapter003 of the CD-ROM and see if you can work out whether it's a person walking or not.

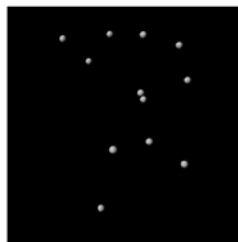

1



7



13



19

When somebody looks to the side, their head will bob down through an arc. When somebody jumps in the air, his or her trajectory will describe an arc. Almost all movements made by any living thing will follow an arc. If the character doesn't follow arcs with its movement, your animation can look stiff and robotic.

## how to design a basic human character

Human beings are one of the most difficult things to animate convincingly. From the moment we are born, we are interacting with other humans. This gives us a subconscious knowledge of how they move. Having this knowledge gives us something to compare the animated character with; the real thing!

When designing a character it is often preferable to simplify and slightly stylize it. The more realistic the character, the more the audience expects it to move realistically. This is why hyper-realistic humans in 3D-computer animation can end up looking like animated shop dummies. The whole point of animation is to make the character look believable rather than real. Real people have many subtle nuances in the way they move that are difficult if not impossible to animate. Just watch a real human being and see how much their face moves when they talk. Remember that you want your audience to follow the story, rather than thinking that there is something a bit weird about your character. This is equally true of 2D and 3D animation.

A good way of working in drawn animation is to divide your character up into a series of simple three dimensional shapes. An oval for the head, a bean shape for the body and sticks for the arms and legs. When animating, animate these shapes first. When you are happy with the movement, start adding the details.

For the 2D animation exercises outlined in the book, we will be using a very simple character, as shown in the illustration.

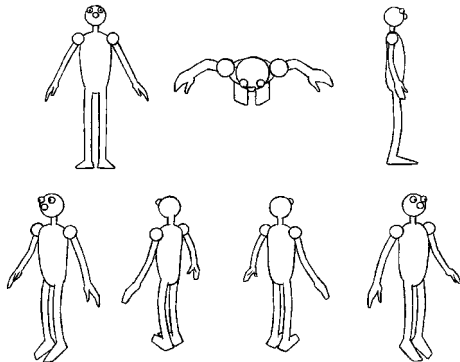
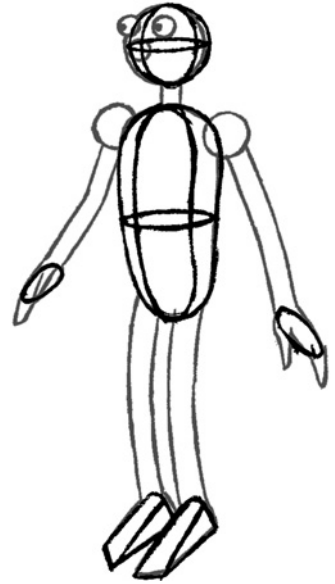

For the 3D animation exercises outlined in the book, we will be using a very simple character as shown in the illustration below.

The character is made up with two arms, two legs, a sphere for the head, a body like a bean

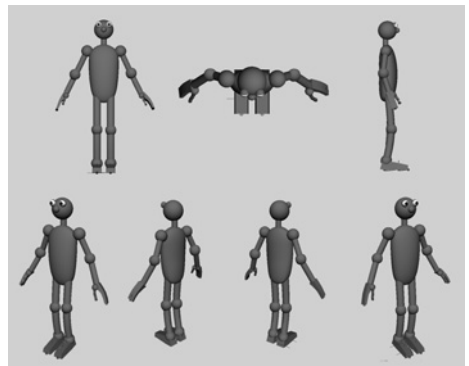

and basic mittens for hands. The feet have a joint at the ankle and toe.

You can design your own character, but bear in mind that it is easier to do the exercises and then apply the timing and spacing learnt to a 3D character that is similar to the 2D drawn one.



When designing a character there are a number of points to look at:

- complexity
- graphic nature of character
- strong silhouettes
- weight and balance

### *complexity*

Decide how much animation you wish to do. In full animation (the kind of animation that you will see in feature films, where the character is moving all the time) the characters tend to be simpler. There will be few buttons, frills or details. Too many details will distract the eye and can cause full animation to look clumsy. It also takes a considerable amount of time to animate a waistcoat full of buttons throughout an entire film. Disney knew this in the 1930s. It was estimated that each button on a character would cost several thousand dollars for the length of a feature film.



For limited animation (the kind of animation that you see in TV series, where the characters tend to stop and start, or jump from one strong pose to another), characters can be more complicated. Mainly because they won't be moving as much.

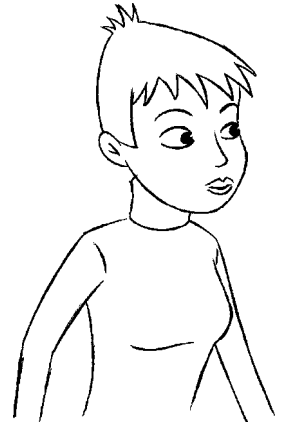

This is also true of 3D animated characters. The more textures and details you add to your model, the more difficult it is to read what the character is doing. Also the more complicated the character, the more difficult it is to achieve elegant animation.

### *the graphic nature of characters*

The more complex the character is the slower the animation has to be.

A simple flat graphic character that consists of blocks of colour will read (the audience will understand what it is doing) more quickly than a complicated three-dimensional one. For the same reason that adding lots of details affects the speed at which you can animate a character, the flat, graphic character can be moved at a faster pace than the complicated three-dimensional one. It's because there is so much more to look at. With a 3D character you've got shadows and highlights, colour and texture, various details that you may have added as well as the animation.

Line drawings also need more time to read than coloured animation. When animating for a black-and-white sequence (or if you are going to convert the movement to 3D) make the animation for the line test slightly slower than you think it should be. If the line test is going to be coloured using flat colours, make the line test slightly faster.

The shapes of the character will also affect how it animates. Characters made from rounded shapes tend to be easier to move in three dimensions and easier to make strong poses with.

The rounded shapes also suggest softness. Angular characters made from hard sharp shapes look clumsier when moving and tend to look more aggressive.

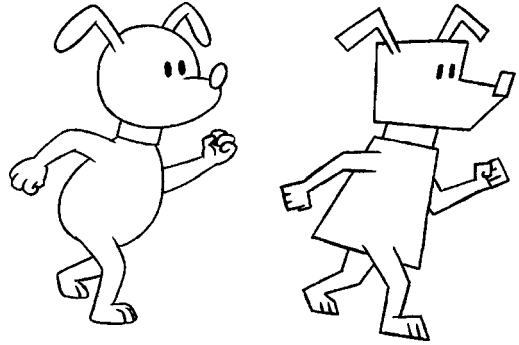

The type of animation used also influences the pace of the animation. 2D drawn animation is suited to a fast, frenetic pace. It is not very good for slow moving or subtle close-ups of a character's face. However, clay or puppet animation works better with subtle, slower, close-up movements and is not so good at the fast frenetic stuff. Computer 3D animation has both the advantages and disadvantages of these two disciplines. It can move faster, with more fluidity than clay or puppet animation, but is not as good with the subtle, close-up work. It is better at close-up work than 2D drawn animation, but is not as good with fast, fluid or aggressive movements.

Please remember that these very general rules and there are many brilliant exceptions to them.

### *strong silhouettes*

When drawing your key positions, make sure they have good silhouettes. If you were to black out the character, would you still be able to understand what the character was doing? If the answer is yes, this will help the audience to understand what is happening faster.

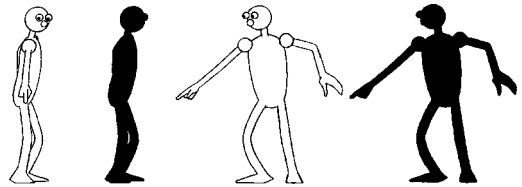

When animating in 3D always think of the camera angle that your final animation will be viewed from and make sure that you have good strong silhouetted poses that work from that angle. Don't do the animation and then sort the camera angle out later. If you want to do a flying camera move make sure that every frame is well composed during the sequence.

### *weight and balance*

For your audience to believe that your character is a living, breathing being (rather than graphite scraped onto paper or a collection of pixels on a screen), you need to follow a few basic rules. Two of these are giving your character weight and ensuring your character is balanced correctly.

### **gravity**

Assuming we are animating a character on planet Earth, the first thing it has to deal with is gravity. In the same way that our bouncy ball falls to the ground and bounces, when rolled off the roof, so our character will fall to the ground and bounce if it jumps off the roof.

If the character jumps into the air, this takes effort and will always result in the character falling back to earth.

Every object (including our character) has a centre of gravity. With our balls it would be in the dead centre. With a character it will be roughly at the bottom of the rib cage (about the centre of the body). If the object or character is taller, then the centre of gravity will be higher. If it is shorter, then the centre of gravity will be lower.

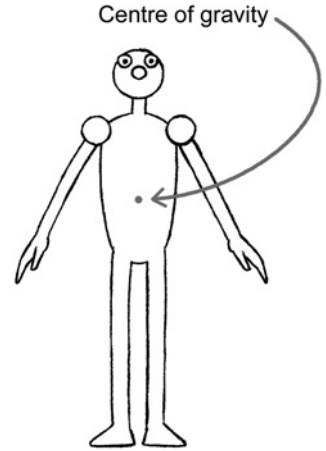

The centre of gravity is not always in the same place within a character. It will change position as a character changes its body posture.

### balance

The stability of an object is affected by its shape. The wider the base then the more stable it will be. For example, a cube is a very stable object. It is difficult to push over or roll down a slope.

A ball, on the other hand, is much less stable. It is easy to push along or roll down a slope. Because of this instability it is much more susceptible to the forces of gravity.

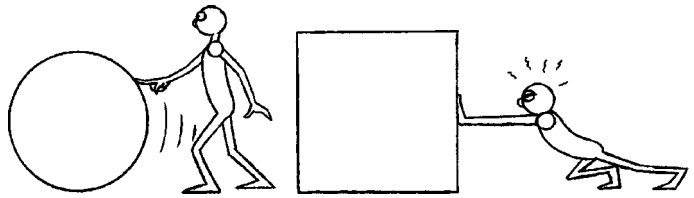

Our character maintains stability by spreading its legs. The wider the legs are spread, the lower the centre of gravity and the more difficult it is to knock over the character.

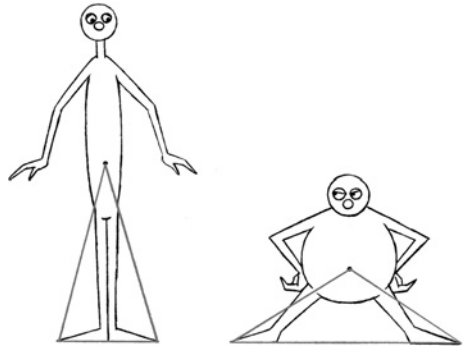
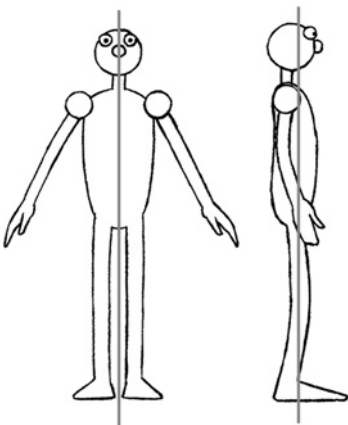

To ensure that your character looks balanced, imagine a plumb line running top to bottom through the centre. There should always be an equal amount of weight either side of this line.

As the character leans in one direction, the plumb line will move with the centre of gravity. If it swings far enough to



reach a leg, then other parts of the body will need to be moved to maintain balance and to stop the character from falling over. For example, if a person leans forward to maintain their balance they need to stretch their arms out behind them. If they lean further, they will then need to stretch one leg out behind them.

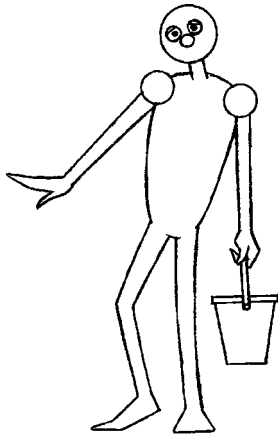

If a person holds a heavy bucket of water, they will lean their body at the opposite angle to the arm holding the bucket.

Someone who is overweight will need to lean back to balance his or her large stomach.

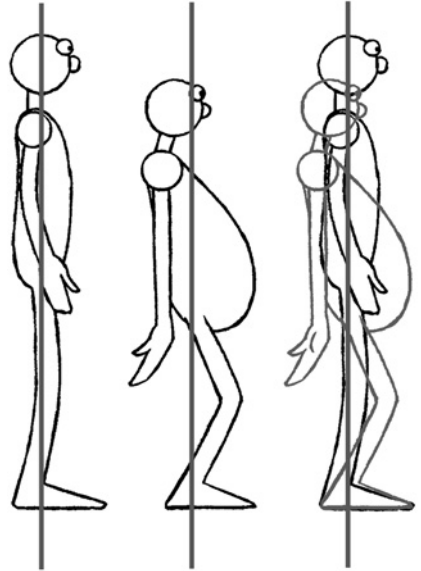

## how to design a 3D character

The thing to bear in mind when designing and building a 3D-animated character is to KEEP IT SIMPLE! You could build the most complicated character in the world, but if it's very complexity makes it awkward to animate it completely defeats the object of the exercise. Internally, think of your character as being like a racing car. All the controls are cut down to a minimum and are easily accessible. There won't be any cup holders, electric windows, climate control and the 101 other gadgets that you might find on a standard road car. This simplicity will speed up the workflow of your animation and mean that you don't have to save as many keys on each part of your model. It will also make life a lot easier when it comes to controlling the animation curves of your scene. Less keys, less curves, less wasted time.

Also think about keeping the 'look' of your character simple. The more complicated the design of the character, the longer it takes an audience to take a character in and the slower you need to animate your character. And slow animation usually leads to boredom on your audience's part. Every fold in the drapery, every pimple and hair, every button and pinstripe, every wrinkle and texture will distract the eye of the audience and make the animation look stilted. All of this 'clutter' takes away from your characters performance. It's also much more difficult to 'stage' a complicated character. One of the most important parts of animating a scene is producing good strong 'silhouettes' at all your key poses.

The most important thing to bear in mind is that the more realistic you make your character, the more the audience will demand that your character moves in a realistic way. A real human being sat in front of you has hundreds of tiny, almost imperceptible movements occurring across their face and body, even when they are not doing anything. It's virtually impossible for an animator to replicate all of these movements convincingly without spending a huge amount of time and effort. This is why almost every photo-realistic human character I've seen in the movies always looks a bit creepy. Only a fraction of the muscles of the face are moving, the joints are not following graceful arcs and the eyes never seem to be looking in the right place. They end up looking like a shop dummy that's come to life. In the end, rather than make a photo-realistic human model and animate it, wouldn't it be better to film a real human being?

There is certainly a place for photo-realistic human models. In particular, as digital stunt doubles in live action films. But generally, the scene where the girl is being saved by the super hero as she plunges to her death are done in long shot and inter-cut with live action close ups. The strength of the animation is down to the scene planning and the editing.

Photo realistic animals are a different case in point. An animal's face has far fewer muscles with which to pull facial expressions, so there is less for the animator to do. Also, as soon as an animal talks we are into the world of fantasy and this will kick off something in your audiences head that allows you to get away with more stylised animation.

A simpler, more stylised character means that your audience is more forgiving when viewing your animation. They will not be demanding perfectly realistic movement and it means that you can get away with exaggerating and making the movement more fantastic than you can with a realistic character.

In the end the movement is more important than the model (but then I would say that – I'm an animator). The best looking character in the world will look terrible if it is animated badly, whereas a stick figure animated well can engage and delight an audience. It's the same in live action: if you take the most beautiful catwalk model in the world then put her in a movie and she can't act, she won't have a very long movie career.

When it comes to designing your character, first, draw, draw, draw! Draw your character from as many different positions as you can think of. Make it pull as many faces as possible. Fill up an entire sketchbook if you can. Stick all of these pictures up above your desk, so that they are staring down at you. Put together a 'mood board'. A 'mood board' is a large piece of cardboard that you stick all of your reference material onto. This could include photographs and illustrations that you've cut out of magazines or printed up from the Internet. Examples of colours and textures, fabric, rocks and anything that you think will help with the design of your character. Again, stick this 'mood board' above your desk.

It's a good idea to have a go at sculpting your character first in modelling clay. This way you can get a good

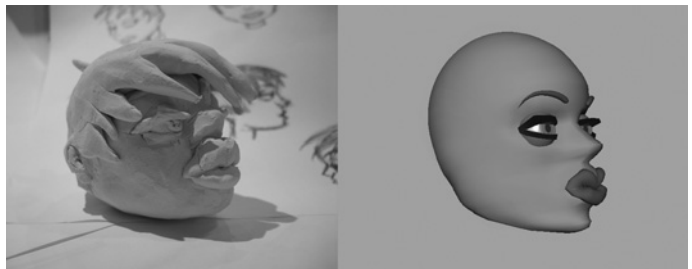

'feel' for your character and it can also save a hell of a lot of time selecting and moving points on your model. Look at it from all sides. Hold it up in front of a strong light source. Does it throw up good silhouettes? Have a go at sculpting all the facial expressions you think your character will pull.

When it comes to applying textures to your character, think about its construction. (A texture map is a flat piece of artwork that is wrapped around your model. For example, it could be the skin of your characters face with areas around the eyes and cheek bones shaded and stubble on the chin.) If it's trousers are separate objects from the torso. It makes it a lot easier to colour them different colours. Painting a texture map for an entire character is a lot more difficult. So the head could be one object. The torso and arms another. The hands would be separate objects as would the legs and feet.

Try to avoid the 'Christmas wrapping paper effect'. This is where a texture has been applied to a model and it bares absolutely no relation to model it is sitting on. It ends up looking like a gift very tightly wrapped in highly patterned paper.

Lastly and most importantly make sure that your model will do everything that is required of it to act out the script of your movie. In other words write the script first. If your character is required to reach up and grab something off a tall shelf, make sure there arms are long enough to reach. For some reason taller thinner characters seem to be easier to animate than shorter fatter ones. Maybe it's because they can produce stronger silhouettes, which means that you can get a pose over to an audience quicker. Maybe it's because you can't fit as much 'clutter' onto a thinner character so there's less to distract from the movement.

## planning a scene

Before animating a scene, it is always a good idea to plan the action with a series of thumbnail sketches. These are simple illustrations showing all the major key poses adopted by your character during the scene. They act as a reference guide and as such are generally small and can be quite rough.



It can be very helpful to have these above the light box as you can often save time by referring to them when drawing the full size keys. You could even have a go at shooting these thumbnails with your line tester to get a rough idea of the timing.

Sometimes it is helpful to sketch these thumbnails onto your x-sheet, roughly at the frame at which these key poses would occur.

To make this easier I've developed a form of x-sheet called a thumb-sheet. This is an x-sheet with small panels in which you can sketch thumbnail drawings.

THUMB-SHEET 01

|               |        |       |            |   |   |         |   |   |            |        |  |
|---------------|--------|-------|------------|---|---|---------|---|---|------------|--------|--|
| ANIMATOR:     |        |       |            |   |   |         |   |   |            |        |  |
| PRODUCTION:   |        |       |            |   |   |         |   |   |            |        |  |
| SEQUENCE NO.: |        |       | SCENE NO.: |   |   | LENGTH: |   |   | SHEET NO.: |        |  |
| NOTES:        |        |       |            |   |   |         |   |   |            |        |  |
| THUMBNAILS:   |        |       |            |   |   |         |   |   |            |        |  |
| THUMB NO.:    | ACTION | SOUND | FRM        | 5 | 4 | 3       | 2 | 1 | BG         | CAMERA |  |
|               |        |       | 1          |   |   |         |   |   |            |        |  |
|               |        |       | 2          |   |   |         |   |   |            |        |  |
|               |        |       | 3          |   |   |         |   |   |            |        |  |
|               |        |       | 4          |   |   |         |   |   |            |        |  |
|               |        |       | 5          |   |   |         |   |   |            |        |  |
|               |        |       | 6          |   |   |         |   |   |            |        |  |
|               |        |       | 7          |   |   |         |   |   |            |        |  |
|               |        |       | 8          |   |   |         |   |   |            |        |  |
|               |        |       | 9          |   |   |         |   |   |            |        |  |
|               |        |       | 10         |   |   |         |   |   |            |        |  |
| THUMB NO.:    |        |       | 11         |   |   |         |   |   |            |        |  |
|               |        |       | 12         |   |   |         |   |   |            |        |  |
|               |        |       | 13         |   |   |         |   |   |            |        |  |
|               |        |       | 14         |   |   |         |   |   |            |        |  |
|               |        |       | 15         |   |   |         |   |   |            |        |  |
|               |        |       | 16         |   |   |         |   |   |            |        |  |
|               |        |       | 17         |   |   |         |   |   |            |        |  |
|               |        |       | 18         |   |   |         |   |   |            |        |  |
|               |        |       | 19         |   |   |         |   |   |            |        |  |
|               |        |       | 20         |   |   |         |   |   |            |        |  |
| THUMB NO.:    |        |       | 21         |   |   |         |   |   |            |        |  |
|               |        |       | 22         |   |   |         |   |   |            |        |  |

There are empty thumb-sheets in chapter003 of the CD-ROM.

## animating your characters

(Using the left and right sides of the brain)

The human brain is divided into two halves. There is a theory that different thought processes are associated with each side of the brain.

The left-hand side deals with the logical, practical, analytical, conscious world. It deals with language and speech and the visual interpretation of the world around us. It also deals with the right-hand side of the body.

The right-hand side of the brain deals with the creative, spiritual and subconscious aspects of us. It's the side that's working when we have a 'feeling' about something. It's also the side of the brain that thinks of the body as a whole.

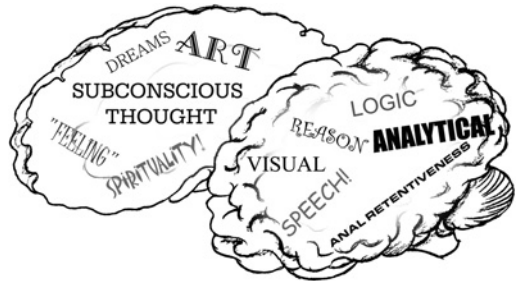

When you are animating you should be using the right-hand side of the brain. In order to do this, it is best to work fast and rough. Don't rub anything out. If the lines are in the wrong place, re-draw them until the drawing looks right. Don't be precise about the drawing at this stage. Also, don't think too much, just draw.

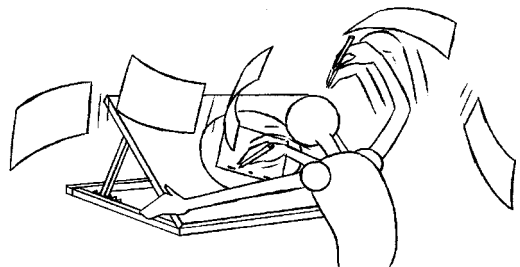

Remember to use a colour erase pencil for the rough drawings. You can then mark a clean, correct line with a graphite pencil. Always keep flipping, flicking and rolling.

For this way of drawing to work, you need to have studied the movement beforehand. Get a friend to act it out or watch yourself in a mirror. Study how the limbs move, any twists to the body. Look at the balance and the weight.

While acting out the move, use a stopwatch to work out the rough timing. If you don't have a stopwatch, the phrase 'one little monkey ... two little monkeys ... three little monkeys', takes about a second to say or about a third of a second to say each of these words. Use this to help with the timing. Slug out your x-sheet. This uses the left side of the brain. This deals with the logical, practical, analytical, conscious world.

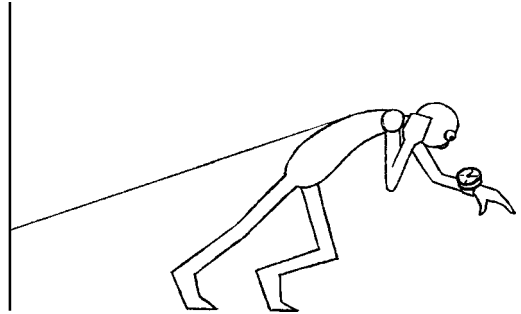

## exercises

To understand weight and balance we will animate a human character lifting a heavy ball and pulling and pushing a heavy object.

The three exercises have been set out step by step as follows.

- Working out the key drawings (I've included timing charts with each of the key positions to show where the in-betweens should be placed).
- Completing the in-betweens.
- Animating each exercise in the four 3D programs covered in this book, using the drawn animation as a guide. These can be found on the CD-ROM.

You can follow the exercises I've done or use them as a rough guide and animate something that you've acted out yourself.

### *the lift in 2D*

In this exercise we will get our character to pick up a heavy ball. For the majority of the time, the character should be balanced, i.e. there should be an equal amount of weight on either side of the imaginary plumb line.

Before you put pencil to paper, act out the movement. Find a reasonably heavy object (I would suggest a bowling ball, but not everyone has one of these lying around) and have a go at picking it up. Remember to lift the ball correctly.

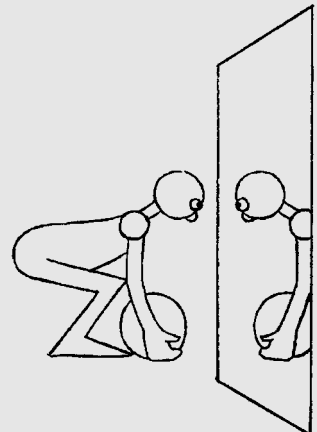



Keep your back as straight as possible and bend your legs to bring yourself down to the ball. When you pick up the object, use your legs to provide most of the momentum (the largest muscle in the body is at the top of the leg) and keep your back straight.

By acting out this sequence, you should have an understanding of the movement, getting the different stages clear in your head. I have provided some thumbnail sketches but use these as a guide. Use your own research to guide your animation for this sequence. This will influence the way you animate the scene, bringing something of you to your animation.

When you act the sequence, exaggerate the weight of the object you are picking up. This will help the animation to work better. By exaggerating the weight of the object it makes the action more clear to the audience.

It can also help to study mime artists. These performers are trained to give the illusion of acting with props that don't exist. In animation the props exist, but they have no substance.

### working out the key positions

The first stage is to draw the key positions and then shoot them on a line tester. There are 10 key positions for this sequence. The sequence is 100 frames long.

(Remember to have a go at 'slugging out' the x-sheet. That is, fill out a description of all the key positions in the action column of the x-sheet.)

The first key position is at frame 1. Begin with your character standing over the ball. Make sure the ball isn't too far away; otherwise as the character bends, they will end up having to reach too far forward.

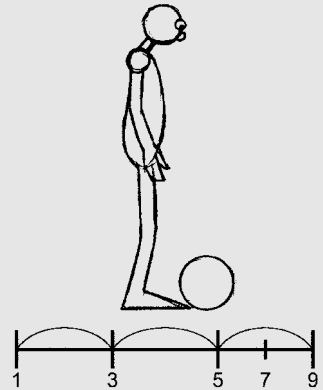

The second key position is at frame 9. Move your character up slightly. This is the anticipatory move (more about anticipation in the next chapter).

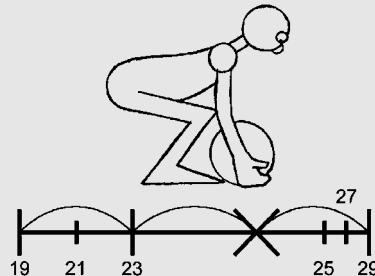
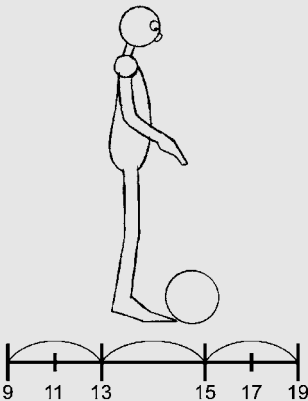

The third key position is a frame 19. This is where our character is grabbing hold of the ball. The hands should be placed at the lower part of the ball.

The fourth key position is at frame 29. As the character starts to pick up the ball, his body will lean back and his bottom will go down. The weight of the ball causes the arms to become straight and even stretch a bit.

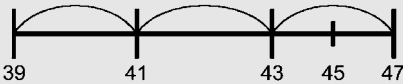
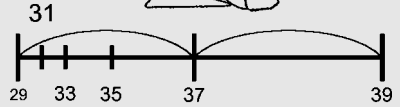
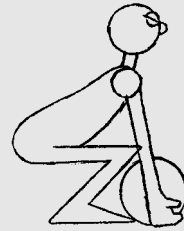

The fifth key position is at frame 39. As the weight of the body is moved backwards, the arms straighten and the ball leaves the ground. The ball swings between the character's legs.

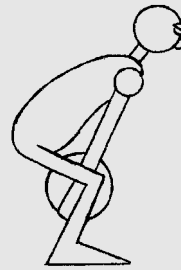

Think of the arms being straightened by the weight of the ball and swinging like a pendulum. As the ball travels between the legs, it crosses the plumb line and causes the character to lean forward.

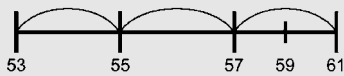

The sixth key position is at frame 47. As the body is raised further, the ball will swing further between the legs of the character, causing the body to lean backwards.

The seventh key position is at frame 53. The character slows down as he goes onto his tiptoes. This is the overshoot position (more about overshoot in the next chapter).

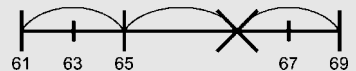

The eighth key position is at frame 61. As the character starts descending towards the resting position the ball keeps moving upwards. This is because the ball contains momentum from being picked up and wants to keep going.



The ninth key position is at frame 69. Our character has moved up slightly from the last key position and the ball has fallen down against its legs.

The tenth key position is at frame 75. Here the character has dropped down slightly and is leaning back and bending the legs to take account of the weight of the ball.

When you've drawn these key positions, shoot them on your line tester (see lift\_2D\_keys.avi in chapter003 of the CD-ROM to see how the animation should look).



## in-betweening the key positions

When we were animating the bouncing balls we could stick quite closely to the timing charts. With a human being it's not that simple. The timing charts should be regarded as a rough guide or reminder to you of where the in-betweens should go. You may find that you will have to make some parts of the character's body move faster than others or leave other bits behind in order to make the movement more believable.



Between key position one and key position two (frame 1 and frame 9), make the hands 'drag' a bit to make the wrist movement seem more fluid.

Between the second and third key positions (frame 9 and frame 19), make the hands flail upwards as it moves out of the second key position. As the hand goes downwards towards the ball make it move

outwards towards us to give the idea that it is going to grasp the ball.

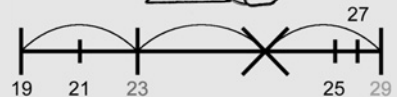

Between the key positions three and four (frame 19 and frame 29), the first bit of the movement is quite slow (19, 21 and 23 are close together) then there is a sudden movement as the arms become taught (a big gap between 23 and 25). At the very end of the movement there are three drawings very close to key position four to decelerate quickly (drawings 25, 27 and 29 are very close together).

Between key positions four and five (frames 29 and 39) there is a slow movement until the halfway point (29 to 37) and then a sudden movement as the heavy ball 'gives' (between the drawings 37 to 39). At frame 37 the body is positioned half way between 29 and 39 but the ball is positioned about a third of the way between 29 and 39. This will give the impression of the ball being heavy.

Between key positions five and six (frame 39 and 47) the ball swings between the character's legs and slows as it reaches the end of its swing



Between keys six and seven (frames 47 and 53) the character reaches the highest position and the ball swings slightly to the right as it is picked up. The arms stay straight and the character goes up onto its toes. The character slows down as this position is reached (49, 51 and 53).



to the left (43, 45 and 47). The arms stay straight and they swing like a pendulum.



Between keys seven and eight (frames 53 and 61) the character comes back down to earth but the ball continues moving upwards, slowing at its apex (57 and 59).

Between keys eight and nine (frame 61 and 69) the ball falls to a resting point against the character's tummy with the arms at full stretch. The ball comes out of its apex slowly (drawings 63 and 65) then falls quickly (gap between 65 and 67) and then slows into the next key (69). This slowing down is caused by the body moving upwards and the arms stretching slightly, the body slowing to its highest point at key nine (69).



Between keys nine and ten (69 and 75) the character comes down to its final resting position, slower out of key nine (the drawings between 69 to 73 are closer together).

Have a look at lift\_2D.avi, chapter003 of the CD-ROM.

### *the lift in 3D*

This scene is 100 frames long.

OK! Lets get animating in 3D. Take all your 'lift' animation drawings and arrange them in a nice pile next to your computer, so you have a reference for each of the key positions. Pin your x-sheet where you can see it so you know the frame number that corresponds with each of your key positions.

Open up the simple character model that I've built that is appropriate to the program you are animating with. So that's mayaman.mb for Maya, maxman.max for 3D Studio Max; xsiman.scn for Softimage XSI and lightwaveman.lws for LightWave. You'll find them in the man\_model folder in, chapter003 of the CD-ROM. (There are also .pdf files on how to build a basic character in each of the four programs. These are in a folder called 'making man' and are called 'building a man in 3DSMax.pdf', 'building a man in LightWave.pdf', 'building a man in Maya.pdf' and 'building a man in XSI.pdf'. Have a go at animating with the model I've provided first, then if you are interested have a go at building your own character.)

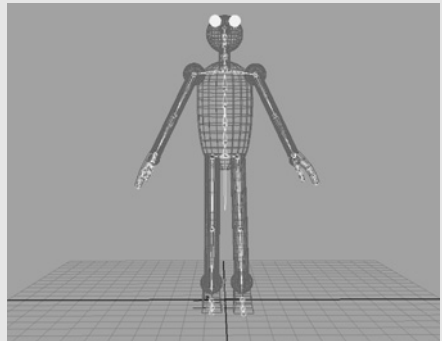

This character consists of a 'skin' made of primitive objects and a set of bones inside that are connected to the skin. The majority of the movement that we are going to do involves selecting these bones at various points and rotating them into the desired position.

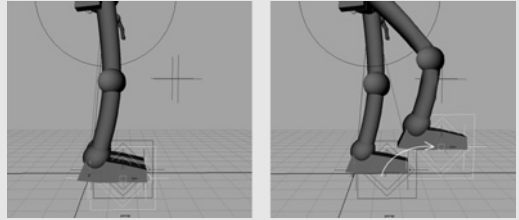

The legs and the arms of the character have been set up with inverse kinematics (IK). This means that you can grab the lower part of the leg (or a 'handle' that is connected to it) and move the entire leg. This can make walking and positioning the feet on the ground easier (but sometimes it causes more problems than it solves).

The feet have three 'handles' attached. One square and two diamonds. The square (called LfootControl or RfootControl depending on whether it is the left or right one) controls the movement and rotation of the foot. The outer of the two diamonds (called RheelControl or LheelControl) controls the rotation of the heel. The inner of the two diamonds (called RtoeControl or LtoeControl) controls the rotation of the toe.

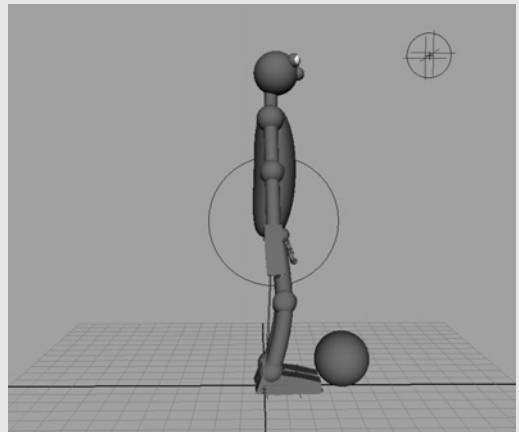
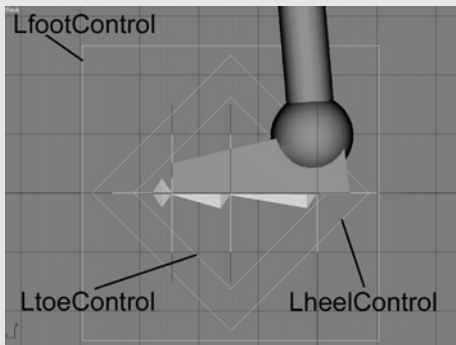

Create a sphere 1.3 units in diameter (13 units for 3D Studio Max) and place it at the feet of your character in the same position as key 1 of the drawn animation (about 3.5 (35 in Max) in X and 1.3 (13 in Max) in Y).

(We also need to make a second ball to attach to the hand of the character. The reason for this is that if you try to get your character to pick up a loose ball, it slops all over the place in its hands. The first ball will stay on the ground all the way through the scene. At the point that the character grabs the ball it will become invisible. The ball attached to its hand has been invisible up to that point and will then become visible. This all happens at frame 29.)

Then you need to move your character into each of the major key positions at the appropriate frame numbers and tweak the way the computer does the in-betweens. This is done either by adding extra key frames (breakdowns) or by manipulating the animation curves appropriate to your program.

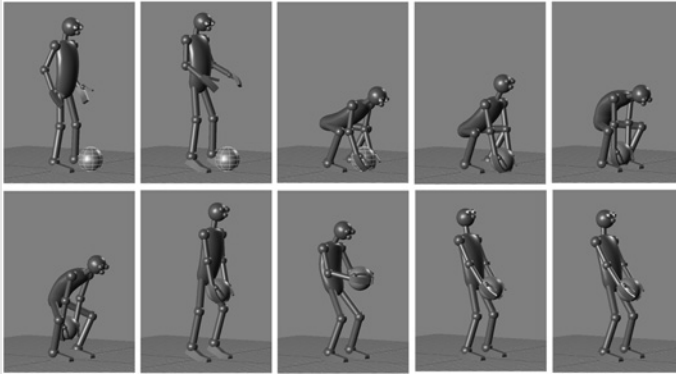

As with the drawn animation, you will need to add some extra key positions to improve the animation. Set these extra key positions at the equivalent of the breakdown positions of the drawn animation.

Between key position one and key position two, make the hands drag a bit to make the wrist movement seem more fluid.

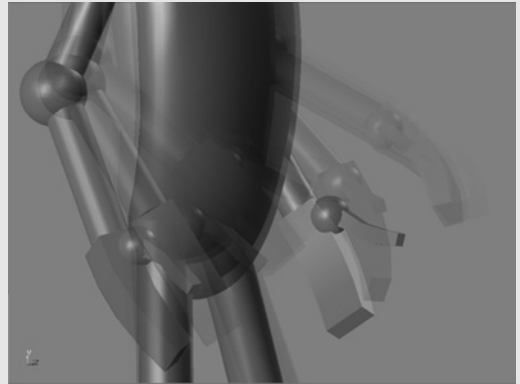

Between the second and third key positions, make the hand flail upwards as it moves out of the second key position. As the hand goes downwards towards the ball make it move outwards towards us to give the idea that it is going to grasp the ball.

Draw on the screen with a chinagraph pencil to mark previous key positions as a guide to your animation.

Have a look at lift\_3D.avi, in chapter003 of the CD-ROM.

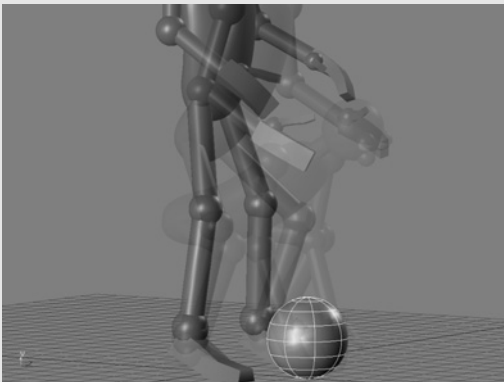

In chapter003 of the CD-ROM, you will find .pdf files that go into more detail about how to do the lift animation exercise in each of the four animation programs. These are called 3DSMax\_lift.pdf, lightWave\_lift.pdf, Maya\_lift.pdf and XSI\_lift.pdf.

## *the push in 2D*

In this exercise we will get our character to push a heavy object. In this case it is a heavy block.

To get a feeling for this, try pushing something heavy. If you cant find anything, then try leaning against a wall facing it and pushing. This will give you an idea of how to approach this exercise. As your character leans against the block you will find that the plumb line will be forward of the legs. The further forward your character leans, the heavier the block will look.

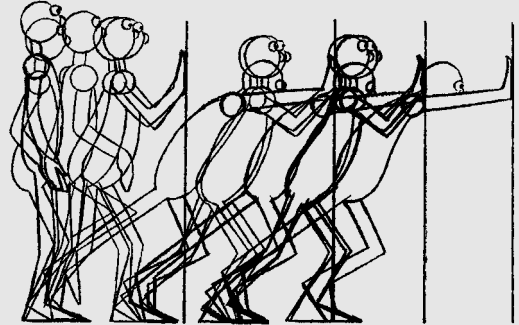

Imagine that the block is pushed along when our character has both feet on the ground. The block moves a little, then stops. The character takes a step, then when both feet are on the ground the block is pushed again. It moves a little and stops, the character then takes another step and so on.

### **working out the key positions**

The sequence is 130 frames long.

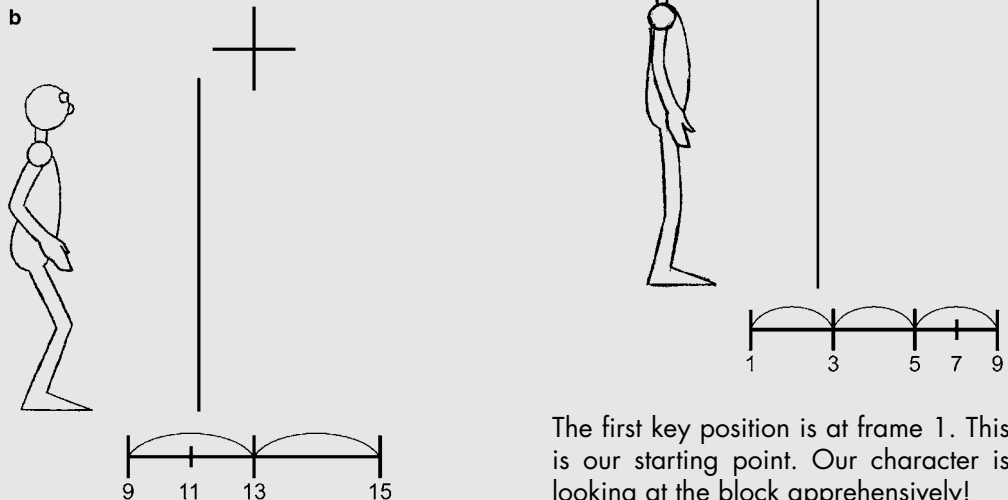

The first key position is at frame 1. This is our starting point. Our character is looking at the block apprehensively!



The second key position is at frame 9. This is where our character bobs down in anticipation of stepping towards the block.

The third key position is at frame 15. At this point the character is halfway through the step towards the block.

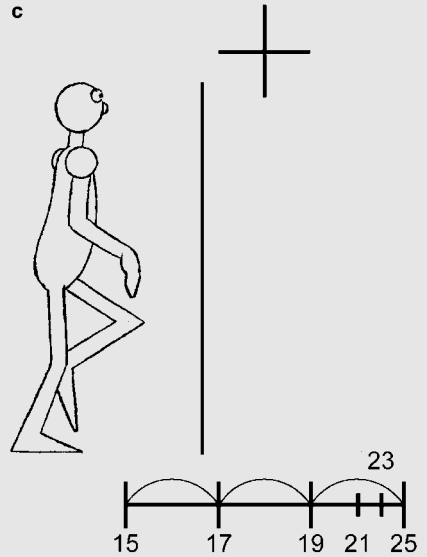
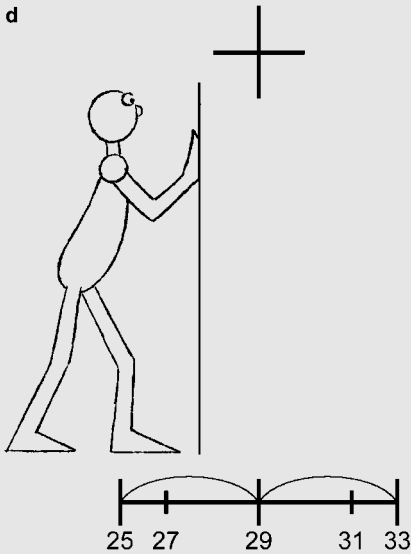

The fourth key position is at frame 25. Our character places his hands on the block.

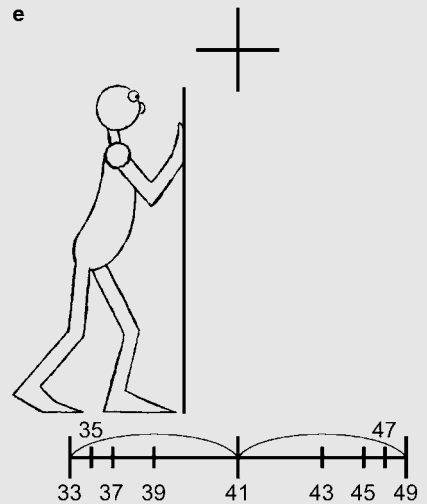
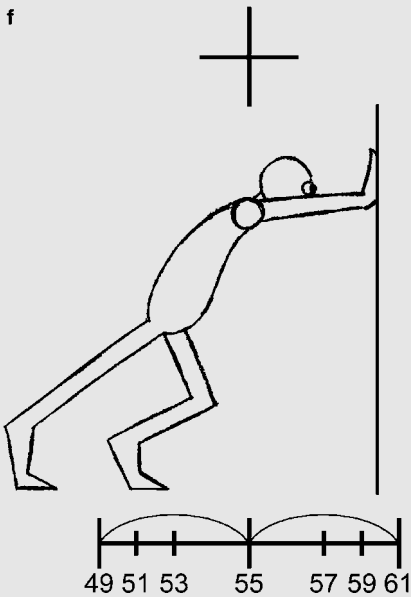

The fifth key position is at frame 33. The body moves slightly forward but because the block will not move immediately, the hands stay in the same place and the elbows bend, closing the gap between the hands and the shoulders.

The sixth key position is at frame 49. The block starts to move as the arms straighten and the body angles forward and the legs unbend. The body is now at full stretch and the block stops moving.

The seventh key position is at frame 61. With the block now stationary, the character takes a step towards it. This key position is very much like the fourth key position but one step ahead.

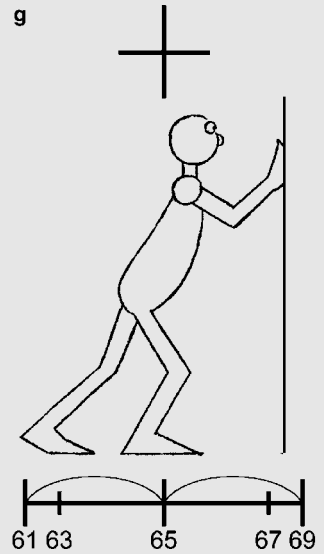
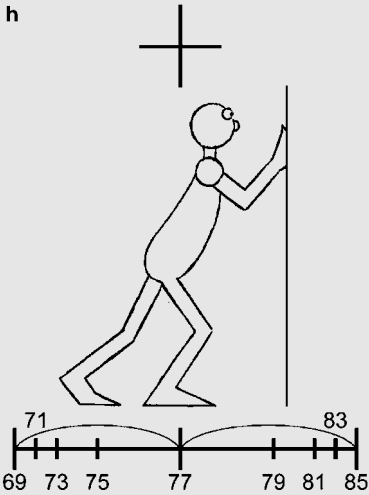

The eighth key position is on frame 69. The body starts moving but the block and hands stay in the same place so the arms bend a little.

The ninth key position is at frame 85. The body is now at full stretch and the block has moved.

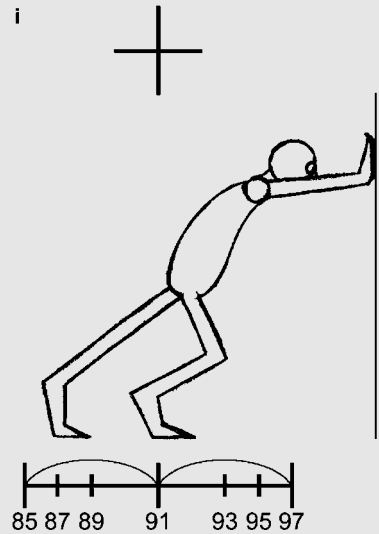
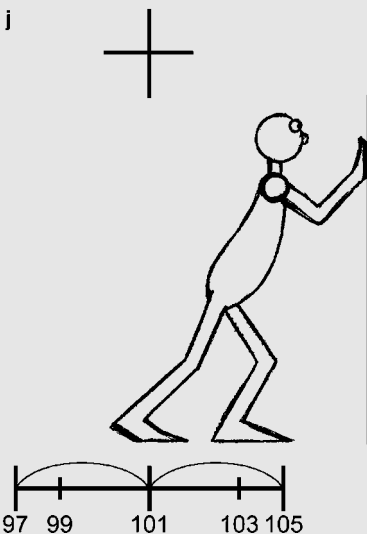

The tenth key position is at frame 97. The character has taken a step towards the block.

The eleventh key position is at frame 105. The arms bend as it starts pushing.

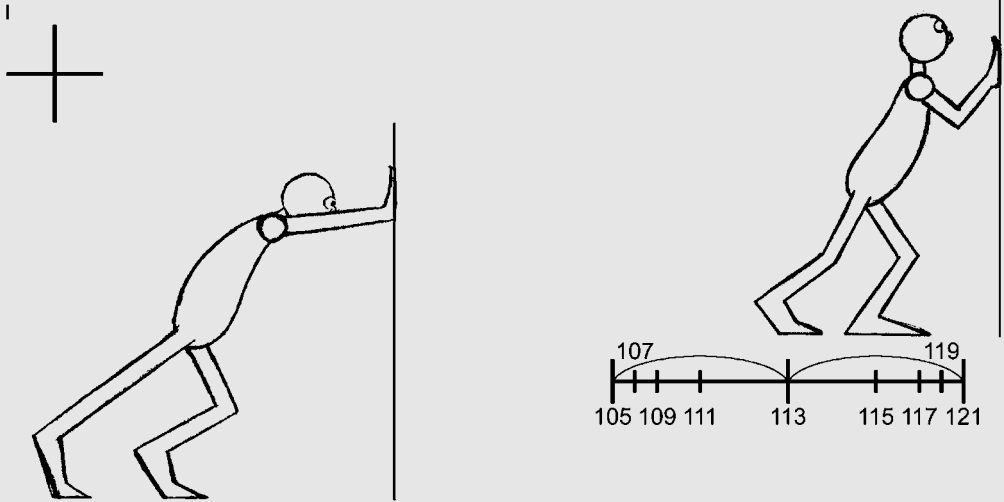

The twelfth key position is at frame 121. The final key position has the character at full stretch having pushed the block.

Shoot the keys on your line tester. Once you are happy with the timing, mark up the key positions on an x-sheet and re-number them by the frame (see `push_keys.avi` in chapter003 on the CD-ROM).

### in-betweening the key positions

The in-betweens between the first, second and third key positions are fairly straightforward and follow the timing charts. Drag the head slightly on the way down (between frames 1 and 9) and drag the hand slightly on the way up (between frames 9 and 15).

With the in-betweens between the third key position (frame 15) and the fourth key position (frame 25), have the hand describe an arc through the wrist before it is placed on the block.

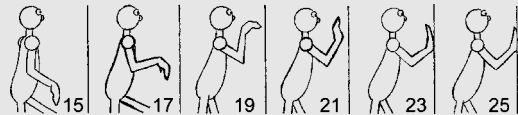

The in-betweens between the fourth key position (frame 25) and the fifth key position (frame 33) are where the character moves slightly forward but the block won't give. These are fairly straightforward, so just follow the timing charts.

With the in-betweens between the fifth key position (frame 33) and the sixth key position (frame 49) have the back arch up to the shoulders as the block is pushed. The arms lock straight at the breakdown position (frame 41) and stay straight until the sixth key position (frame 49).

The in-betweens between the sixth key position (frame 49) and the seventh key position (frame 61) are where the character takes a step towards the block, so the breakdown (the major in-between at frame 55) will be a 'cross over' position. This is where one leg is picked up and crosses over to be placed down ahead of the other.

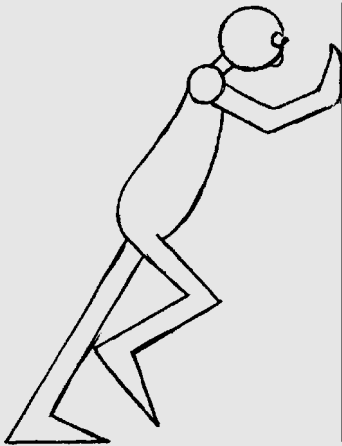
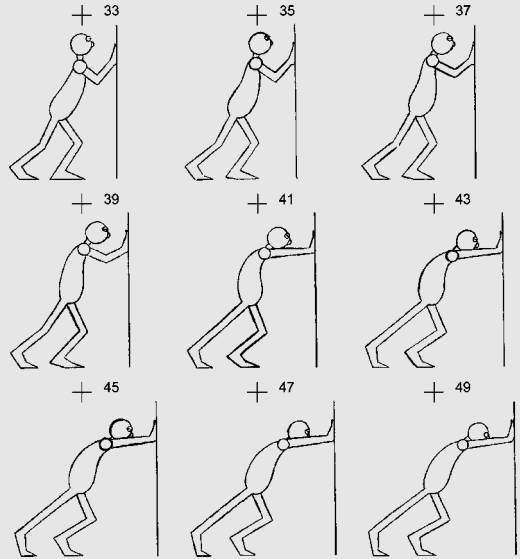

The rest of the in-betweens in the sequence repeat the pattern set above. Between keys seven and eight (frames 61 and 69) the in-betweens are a repeat of those between keys four and five (frames 25 and 33), where the character does the initial move before the block starts to move. Between keys eight and nine (frames 69 and 85) the in-betweens are a repeat of those between keys five and six (frames 33 and 49) where the block is pushed. Between keys nine and ten (frames 85 and 97) the in-betweens are a repeat of those between keys six and seven (frames 49 and 61) where the character takes a step towards the block, only the other leg does the cross over. Keys ten and eleven (frames 97 and 105) are in-betweened like those between keys four and five (frames 25 and 33). Finally the in-betweens between keys eleven and twelve (frames 105 and 121) are a repeat of those between keys five and six (frames 33 and 49)!

Take a look at `push_2D.avi` in chapter003 of the CD-ROM to see the completed sequence.

### *the push in 3D*

Load your character into the scene and save the scene as 'push'. Create a block for your character to push which will be 15 units by 15 units by 15 units (or in 3DS Max

150 units by 150 units by 150 units). Place this block about 5 units (or in 3DS Max, 50 units) in front of your character.

Set keys at each of the appropriate key positions, just like your drawn animation, and slide the block along at each of the pushes. Hopefully you'll have something that looks like `push_3D_loose.avi` in chapter003 of the CD-ROM.

Open up the animation curves in your program, select all of the key positions and convert the curves to stepped (Maya), constant (XSI), etc. You should then have something that looks like `push_3D_keys.avi` in chapter003 of the CD-ROM.

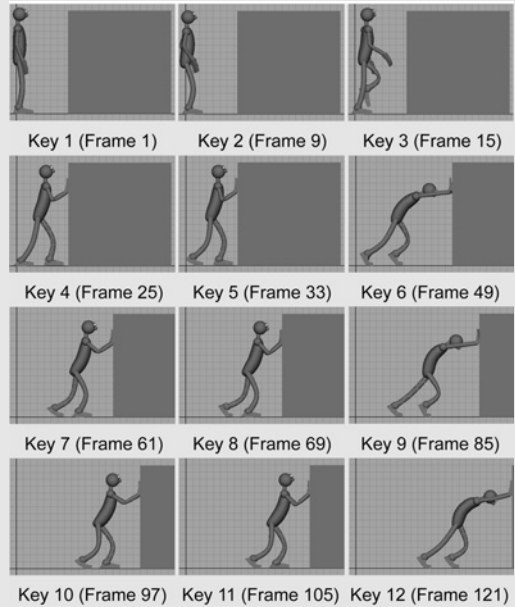

Take out the first two key positions (drawings 1 and 9) of your drawn animation and the in-between drawings (or have a look at the illustrations **a** and **b** on p. 71). The two breakdowns are at frames 3 and 5. On the computer go to frame 3 of your animation and 'ghost' it so that you can see the key positions at 1 and 9 (or better still draw these two positions on the screen with a china-graph pencil). Go to frame 3. Translate and rotate your character so that it is in the same position as drawing 3 (about a third of the way between drawings 1 and 9). When you are happy with this, select everything and set a key. Repeat for frame 5, which is one third closer to frame 9. Frame 7 (the other drawn in-between) should be OK for the computer to do!

Between the second and third key positions (frames 9 and 15) the breakdown is at frame 13 and is halfway between the two keys. Select frame 13 on the time slider and position your character halfway between the key positions at frames 9 and 15 (see the illustrations **b** on p. 71, and **c** on p. 72). One thing that is quite nice to do is to make one of the arms slightly later than the other. This just makes the movement look a bit more natural rather than mechanical.

Between the third and fourth key positions (frames 15 and 25) have the hands follow an arc through the air before they make contact with the block (see the illustrations **c** and **d** on p. 72).

Between the fourth and fifth key positions (frames 25 and 33) we can let the computer do the work for us, so specify that the animation curves between these two key points should be spline (see the illustrations **d** and **e** on p. 72).

Between the fifth and sixth key positions (frames 33 and 49) the character is pushing the block. In order to get the impression of it putting in a lot of effort we need to arch its back at the breakdown position (frame 41). So do this breakdown first and then do the in-betweens either side of it (frames 39 and 43) (see the illustrations **e** and **f** on p. 72).

Between the sixth and seventh key positions (frames 49 and 61) the character takes a step towards the block. The breakdown is the cross over position, which is at frame 55 (see illustrations **f** on p. 72 and **g** on p. 73), half way between frames 49 and 61. Put the time slider to frame 55 and arrange your character into this position and set a key. Then go to frame 53 and position the character halfway between the character's positions at frames 49 and 55. Then go to frame 57 and position the character halfway between the character's positions at frames 55 and 61 (see illustration **f** on p. 72 for the timing chart).

The rest of the in-betweens in the sequence repeat the pattern set above. Between keys seven and eight (frames 61 and 69) the in-betweens are a repeat of those between keys four and five (frames 25 and 33), where the character does the initial move before the block starts to move. Between keys eight and nine (frames 69 and 85) the in-betweens are a repeat of those between keys five and six (frames 33 and 49) where the block is pushed. Between keys nine and ten (frames 85 and 97) the in-betweens are a repeat of those between keys six and seven (frames 49 and 61) where the character takes a step towards the block, only the other leg does the cross over. Keys ten and eleven (frames 97 and 105) are in-betweened like those between keys four and five (frames 25 and 33). Finally the in-betweens between keys eleven and twelve (frames 105 and 121) are a repeat of those between keys five and six (frames 33 and 49)!

Take a look at `push_3D.avi`.

In chapter003, of the CD-ROM you will find .pdf files that go into more detail about how to do the push animation exercise in each of the four animation programs. These are called `3DSMax_push.pdf`, `lightWave_push.pdf`, `Maya_push.pdf` and `XSI_push.pdf`.

## *the pull in 2D*

This last exercise follows a character pulling an object.

Imagine a large block with a rope attached to it. Our character hauls on the rope to pull the block along. The further the character leans away from the block, the heavier it will appear.

As with the other exercises, acting the sequence will help you to get a clear

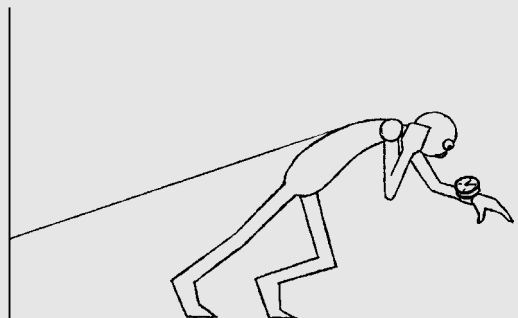

understanding of the movement. You could sit a friend on a chair and try pulling them along.

Remember that you may find a different way of doing this movement from the way I've animated it. If so, do it your way. This sequence is 100 frames long.

The first key position is at frame 1. The character is stood in front of the block with the rope hanging loose from their shoulder.

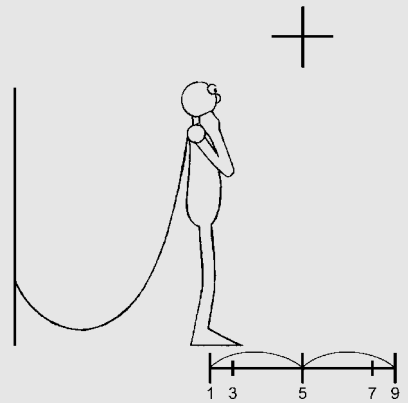

The second key position is at frame 9. This is where the character bobs down in anticipation of the first step.

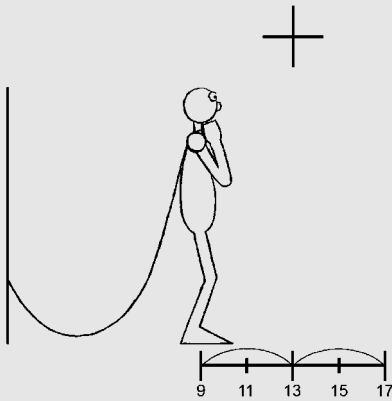

The third key position is at frame 17. At this point the character has taken the first stride and the rope has gone tight.

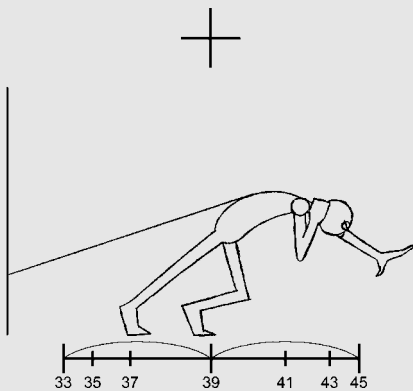
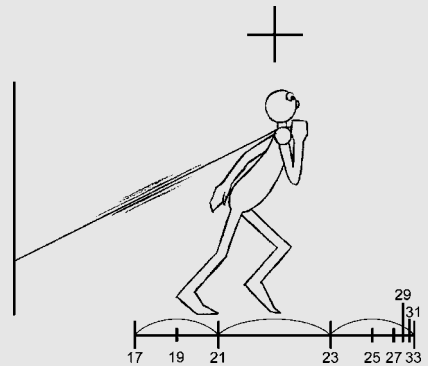

The fourth key position is at frame 33. Both feet are on the ground and our character has leant forward to pull the block.

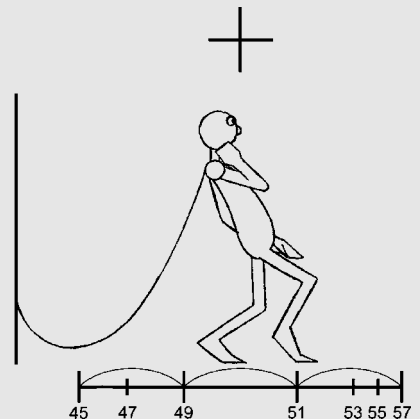

The fifth key position is at frame 45. The character has taken a step forward while leaning the body back allowing the rope to fall loose.

The sixth key position is at frame 57. The character leans forward and the rope tightens.

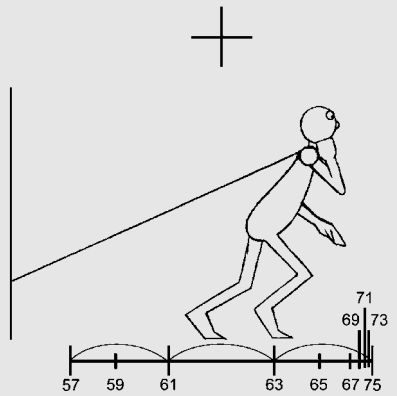
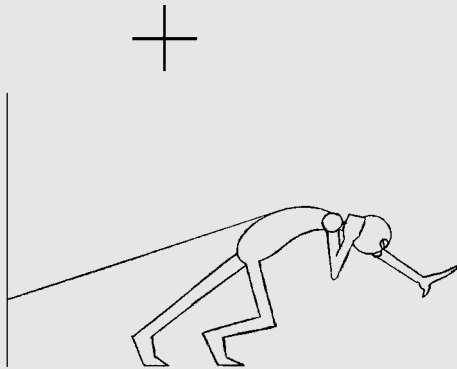

The seventh and final key position is at frame 75. Both feet are on the ground and our character has leant forward to pull the block.

Shoot these keys on the line tester to see how they work. See pull\_2D.avi in chapter003 of the CD-ROM.

### in-betweening the key positions

The in-between drawings follow the timing charts on the whole. Just remember to arch the characters back as it leans against the rope and pulls the block.

These in-betweens occur between the third key position (frame 17) and the fourth (frame 33) and the sixth key position (frame 57) and the seventh (frame 75).

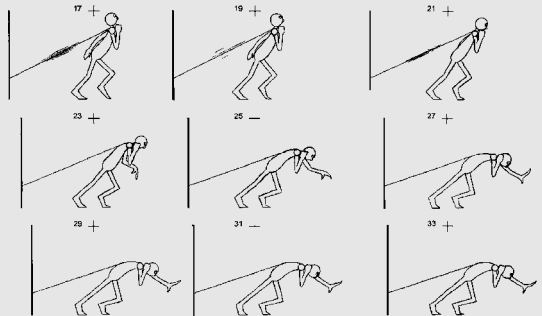

### the pull in 3D

This is the most difficult exercise we've tried so far in 3D. It is particularly fiddly and you have to think about three things at once. The character, the rope and the block and how they relate to each other. The character is always going to be the most important of these three elements. The block and rope react to what it does and give it resistance.

Build a block 15 units by 15 units by 15 units (in 3DS Max, 150 by 150 by 150), just like in the last exercise but place it behind your character by about 11 units (110 in 3DS



Max). You then need to make a rope. This consists of a very long thin cylinder with lots of bones running down the length of it. Make it 25 units in length (250 in 3DS Max) and have a bone for every unit. It should then be attached to the block at one end and the character at the next. The bones then need to have IK attached, to help control the rope.

Work through your drawings (or the illustrations shown in the pull in 2D exercise), manipulating the character into each of the key positions at the

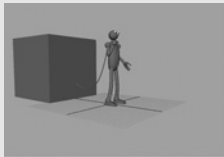
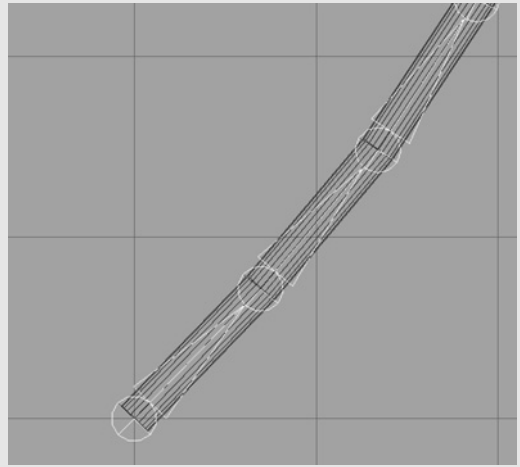

Frame 1

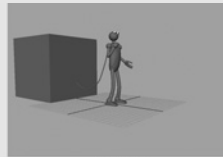

Frame 9

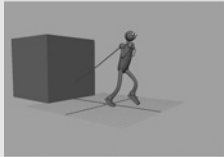

Frame 17

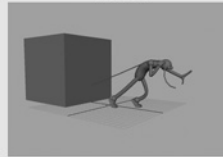

Frame 33



Frame 45



Frame 57

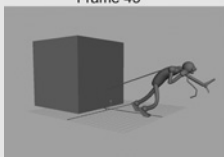

Frame 75

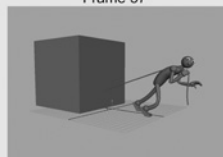

Frame 100

corresponding frames and setting a key on everything!

Take a look at `pull_keys_3D.avi`.

Once the keys are done go back over the animation sorting out the breakdowns, the foot slip and anything else that looks a bit untoward.

Take a look at `pull_3D.avi`.

Getting the rope to work correctly is a real pain, and all the programs have a slightly different way of dealing with it!

On the CD-ROM in chapter003, you will find .pdf files that go into more detail about how to do the pull animation exercise in each of the four animation programs. These are called `3DSMax_pull.pdf`, `lightWave_pull.pdf`, `Maya_pull.pdf` and `XSI_pull.pdf`.

## how to build and rig a simple 3D character

This character is built and ready and waiting for you to animate it. Just have a look in the folder 'man\_models' in 'chapter003' folder on the CD-ROM. However if you want to have a go at building him (and it will give you a better idea of how to animate him later) here are some basic instructions. There are specific .pdf files in chapter 003 folder on the CD-ROM that relates

to the program that you want to use to build this man. They are called; 'Building a man in 3DS Max', 'Building a man in LightWave', 'Building a man in Maya' and 'Building a man in XSI'. Always consult these files when building your man.

There are lots of ways to build and rig a 3D-animated character.

A 3D characters' skeleton will consist of a series of bones (or joints) that are linked together and rotate in relationship to each other (you will hardly ever move or translate these bones). These will, in turn move the skin (or envelope) that surrounds them. The bones need to be linked to the skin. There are several ways of doing this, two ways being:

### *skin and bones*

The most sophisticated way of constructing a character is to build a complete 'skin' and then insert bones within it and link them to the skin. This is referred to as 'skinning' or 'enveloping'. You then need to modify the skin, so that different parts of it move correctly in relation to the bones. This is achieved by 'weighting'. All four programs have slightly different ways of 'weighting' a character. The basic idea is that you select points on the surface of the skin and assign them a differing degree of influence dependent on how each part of the skin should move in relation to the bone. A good way to demonstrate this is the way in which the skin of an arm would move with the upper- and lower-arm bones. If the bones are inserted into the arm without any weighting and then you bend the arm, you will get a rubber hose effect at the elbow. If however the arm is correctly weighted to the bones, the skin at the elbow will move correctly.

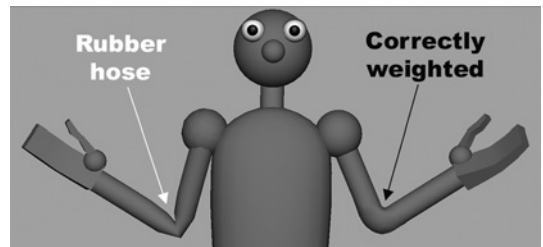

You could go even further and insert muscle groups that expand and contract with the movement of the arm. The possibilities are endless.

What you do need to remember though is that to build an animated character in a feature film there would have been several artists involved in it's construction. First there would have had a sculptor that made a model out of clay, which would then have been scanned into the computer. Then a digital artist would have cleaned up this model within the computer to simplify the mesh. After this a rigger would insert the skeleton and weight the model to make sure it moves correctly. This would also work out things like muscle groups, facial expressions and place 'handles' on the important bones to ease the animation process. After this a texture artist would work out the colouring of the character and a technical director would assign the texture to the skin. This could take weeks if not months.

### *child of the joint*

The other way of building a character is often referred to as 'child of the joint'. The idea is that most of the parts of your character are linked to the bone inside them in the

hierarchy and there would usually be one part of the body per bone. When you select the bone and rotate it, the part of your character that is linked to the bone will move with it. If you have a look at the character that I have built for the exercises in this book, the majority of him is constructed as child of the joint. The upper arm is a cylinder, the elbow is a sphere, the lower arm is a cylinder and the hand is a box shape. The ball of the thumb is a sphere and the thumb is a shaped box. The advantage of this type of construction is that you don't have to do any weighting and is simple and quick to put together. The disadvantage is that you end up with a rather blocky looking basic character.

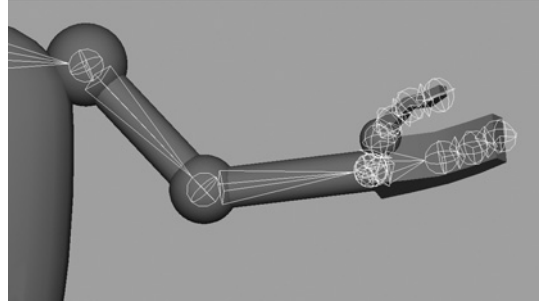

In fact, the man I created has a mixture of skinning and child of the joint. The body is skinned to the six bones of the spine, the neck is skinned to the neck bones, the hands and thumbs are skinned to the hand and thumb bones, and the feet are skinned to the foot bones. The limbs, head, nose and eyes are child of the joint. Most models will be a mixture of skinning and child of the joint.

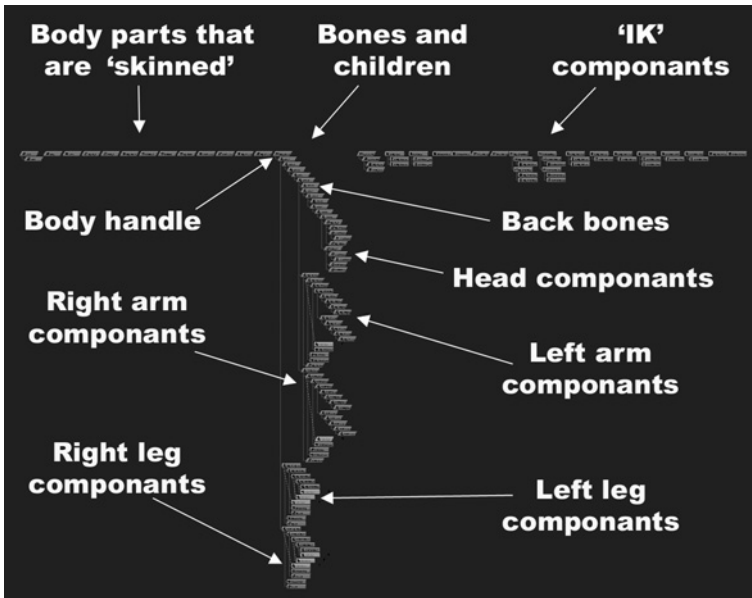

All of these components (the polygons and the bones) will appear in the 'Schematic View' (3DS Max, LightWave and XSI) or 'Hypergraph' (Maya) part of your program.

You can select parts of your man within the schematic view or hypergraph when animating (this can sometimes be easier than selecting parts of your man in the viewport).

So I'm going to show you how to build this model (there are more detailed instructions on how to build the man model in 3DS Max, LightWave, Maya and SoftImage in folder chapter003 on the CD-ROM).

### *first get your body parts*

First you need to create all of the bits that make up the models body.

These consist of separate parts for the head, eyes, eye lids, pupils, nose, neck, body, shoulders, upper arms, elbows, lower arms, hands, thumbs, upper legs, lower legs, ankles and feet. Take a look at the specific .pdf files in chapter 003 folder on the CD-ROM that relate to your program for the dimensions and how to build these parts.

You now need to assemble your man. Arrange him on the centre line of your viewports.

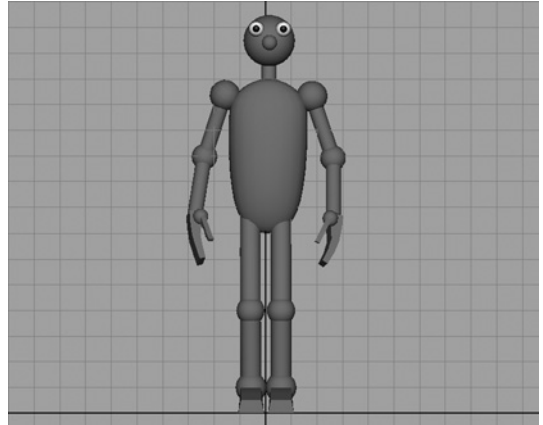

### *putting bones in your man*

Almost all movements within the human body starts at the base of the spine. So this is where we are going to start putting bones inside our man. To create the spine we need to create a chain of six bones that starts at the base of the spine and finishes between the shoulders.

Select a viewport where you can see the man from the side and then select your 'bone creation tool' (called 'Bones' button in 3DS Max, 'Skeleton' button in LightWave Modeler and 'Draw Child Bones' in LightWave Layout, 'Joint Tool' in Maya and 'Draw 2D Chain' in XSI). Start by clicking between the man's legs and then left click evenly up the man's body a further six times to create six bones for the spine. Rename each of these joints 'BackBone01, BackBone02', etc.

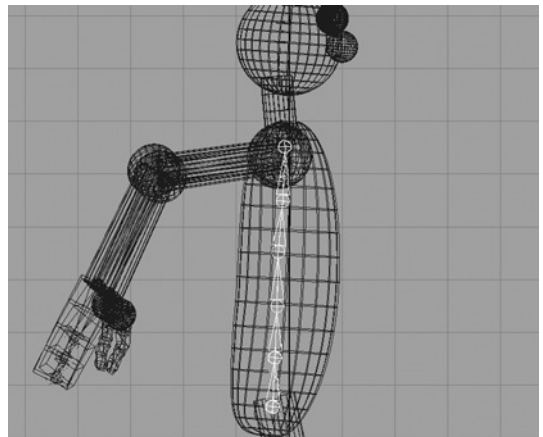

Now we need to put some bones through the neck and head. Left click at the top of your top back bone and then click a further three times to create two bones in the neck and one bone in the head. Name them 'NeckBone01, NeckBone02', etc.

We now need to link the head and neck to the bones inside them. (We will leave the body and spine till later.)

Open up the 'Schematic View' (it's called Schematic View in 3DS Max, LightWave and XSI and the Hypergraph in Maya).

The schematic view gives you a graphic interpretation of your model. Each of the block shapes in the schematic view is referred to as a node and this is a graphic representation of each of the parts of your model. The bones, the polygons and everything else that makes up your model will have a node representing it. These will be arranged in a 'hierarchy'. And if you select a node at the top of the hierarchy everything lower down will be affected by it. For example, if you select the node that represents the arm bone and move it in one of your viewports, the arm will move with it (if the arm is correctly attached to the bone).

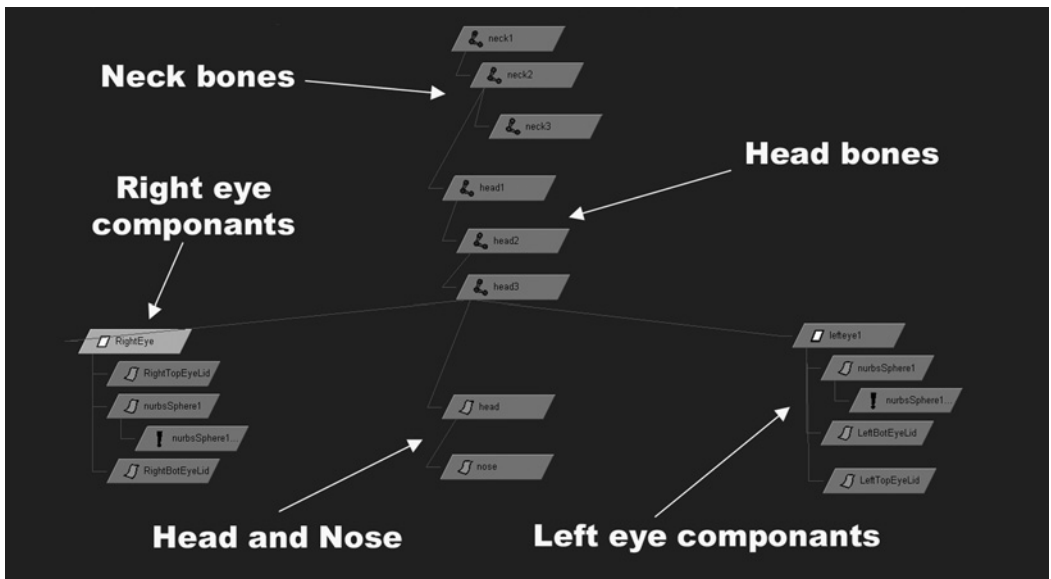

Find the head and neck bones. First we are going to make the head the child of the head bone (link the head bone to the head) so that when we move the head bone the head will move with it.

(Take a look at your specific 'Building man in...' .pdf file in chapter003 of the CD-ROM).

By using the same procedure make the 'RightEye', 'LeftEye', 'Nose', 'RightTopLid', 'RightBotLid', 'LeftTopLid' and 'LeftBotLid' children of the 'HeadBone'. (Don't do anything with the pupils just yet.)

We now need to 'bind' (Maya), 'Skin' (LightWave and 3DS Max) on 'Envelope' (XSI) the neck to the neck bones. This will make the neck bend when the bones within it are rotated. (Take a look at your specific 'Building man in...' .pdf file in chapter 003 of the CD-ROM).

Once the neck is 'bound' to the neck bones we need to connect the neck bones to the back bone. (Take a look at your specific 'Building man in...' .pdf file in chapter 003 of the CD-ROM).

## setting up eye controls

To make the eyes move we need to set up some eye controls. These will be positioned in front of the eyes and when you select and move them the mans eyes will follow them. Create two non-rendering, cross-shaped objects called 'Nulls' (In LightWave and XSI), 'PointHelpers' (3DS Max) or 'Locators' (Maya). You then need to get the eyes to look at these two controls. This is done by applying a 'constraint' between the each eye and each eye control. Its called an 'Aim' constraint in Maya, a 'Look At' constraint in 3DS Max, a 'Motion Option' in LightWave and a 'Direction' constraint in XSI. Then all you need to do is to make a circle and place it in between the two controls and make it the parent of these two controls. So when you move the circle the eyes will follow it. You can also move the controls separately to get a cross-eyed look.

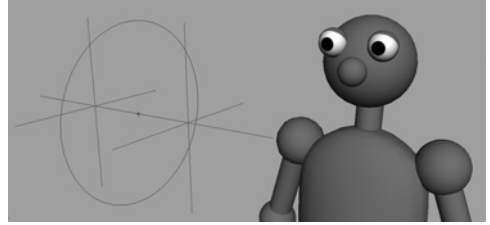

## setting up the legs

To operate the legs we need to use something called 'Inverse Kinematics' (also called 'IK'). Inverse Kinematics is where you can select a control at the end of a limb and move the entire limb (with it's joint in the middle) and place it where you want it and then set a key on it. Think of it as being like the way in which you would move a string puppet. 'Forward Kinematics' (also known as 'FK') is where you would have to move each joint through the limb separately in order to place the end part of the limb to where you want it. Think of this as being more like the way that you would animate a jointed puppet in stop frame animation. Both methods have their advantages and disadvantages. With IK, the joints through the limb can twitch about during the movement but you get more accuracy on where the end of the limb will be (e.g. where the feet meet the floor). You usually have to set up a control on the elbow or knee and set keys on it to stop it twitching about. With FK you can much better flow through the limb when doing follow-through and overshoot but the end of the limb can rattle about when it has to be placed on something (e.g. a hand resting on a table). With this model there will be a very simple example of IK on the arms and a more complicated version on the legs. You could have IK on the legs and FK on the arms. Play around with this model first and then try the same model but without the IK on the arms and see what you prefer.

First draw five bones through the leg and foot. These will be called 'RightThigh' (or 'LeftThigh'), 'RightShin', 'RightHeel', 'RightBall' and 'RightToe'.

Now you need to create three IK constraints (called 'IK Handles' in Maya, 'IK Solvers' in 3DS Max, 'Bank Controller' and 'Pitch Controller' in LightWave and in XSI the IK is

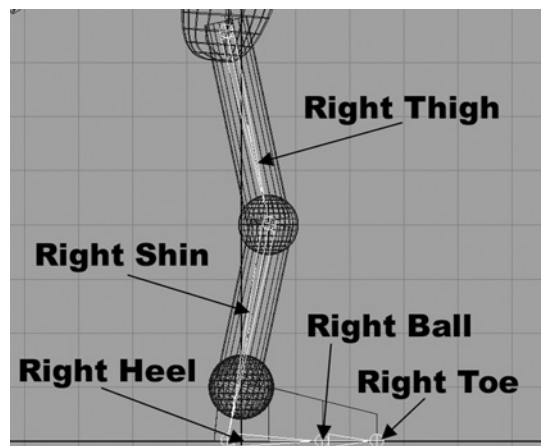

there already in the form of 'Effectors'). These are positioned between the top of the thigh bone and the heel bone, the heel bone, the ball bone and the toe bone.

Now create three squares that are progressively smaller. Position them around the foot as in the illustration. These should be called 'FootControl', 'HeelControl' and 'ToeControl'. You also need to create three pivot points (these can be Nulls, Locators or Point Helpers depending on your program). They need to be positioned at the heel, ball and toe of the foot. Finally create a 'KneeControl' that is positioned in front of the knee.

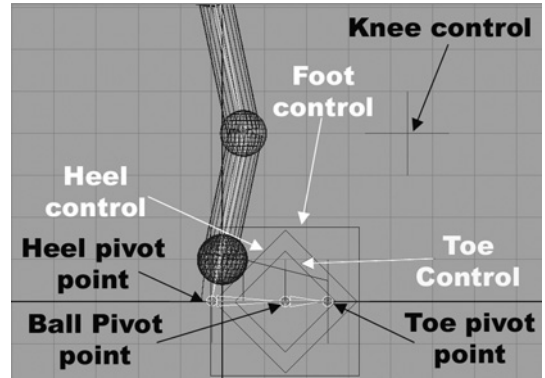

All these parts now need to be linked and constrained to each other (and all in a slightly different way depending on what program you are using, check out the .pdf file on the CD-ROM). Basically you do this: the toe pivot point should be linked to (made the child of) the 'ToeControl', Link both the 'ToeControl' and the 'HeelControl' to the 'FootControl'. Link the IK of the leg to the heel pivot point. Link the IK of the heel to the ball of the foot pivot point. Link the IK of the toe to the toe pivot point. Link the ball of the foot pivot point to the FootControl. Finally constrain the KneeControl to the bottom the leg IK chain. Phew!

Make each of the parts of the leg children of the bones within them and 'Skin' the feet to the foot bones.

The 'FootControl' controls the up down, side to side and rotation of the foot as a whole. The 'HeelControl' controls the rotation of the heel as the toe is kept on the ground. The 'ToeControl' controls the rotation of the toe. The 'FootControl' can be moved up down and side to side and also rotated. The 'HeelControl' and 'ToeControl' should only be rotated.

Next 'Skin' the spine to the body.

Finally we need to put some bones through the arm, hand and thumb. Make the sections of the arm children of the bones within them and 'Skin' the thumb and the hand to the thumb and digit bones. Link the top of the arm to the shoulders and (depending on taste) add IK to the hand of the arm. I always find it easier to animate arms with IK than without.) Also add elbow controls to each elbow (like with the knees). These will help sort out any weird angles that the arms adopt when you move the arm controls.

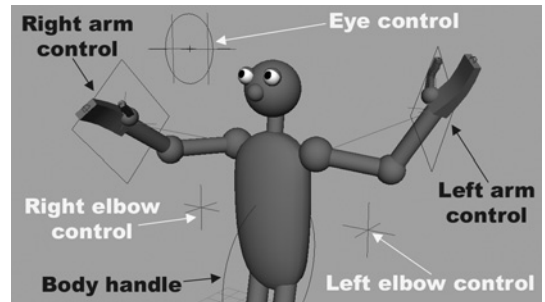

When building your man always consult the relevant .pdf file in chapter003 folder on the CD-ROM.

## chapter 4

# timing, anticipation, overshoot, follow-through and overlapping action with an animated character

### chapter summary

- *timing*
- *anticipation*
  - how much anticipation force*
  - acting and anticipation*
  - double takes!*
  - speed and surprise*
  - anticipation during a move*
  - varying the amount of anticipation*
  - other ways of using anticipation*
- *follow-through*
  - follow-through of inanimate objects*
  - follow-through of animate (living) objects*
- *overlapping action or overshoot*
- *vibration*
- *exercises*
  - the string and stick in 2D*
  - the string and stick in 3D*
  - the dive in 2D*
  - the dive in 3D*



## timing

This is probably the most difficult thing to teach and learn about in animation. Timing makes a movement witty or touching or relevant. It is central to any form of film making, whether live action or animation. It runs through all elements of visual moving imagery. Every chapter in this book is about timing.

Timing is about conveying information to your audience so they can follow the action. I always think that good timing is the minimum period you give your audience to understand what is happening. If you make a move or a pose too quick, they won't follow what's going on, make a move or a pose too slow and the audience will be bored. Timing will control how your audience reacts to what they see. Sometimes you will make your audience wait for the action, or you can lead your audience to expect one thing to happen and then another thing happens (surprise is the basis of a lot of humour). You can lull your audience into a state of complacency through repetition and then make your character do something different. These are only a few examples of the use of timing but you can see what I mean about it being difficult to teach.

I touched on timing in Chapter 1 and I have been through the basic stages of working out timing during the exercises. To recap, these are as follows. First, draw the key positions (making sure they are as clear as possible) and shoot them on a line tester for the required amount of time (see Chapter 1). Then vary the number of frames each drawing is held for, until you have a series of stills that express all the information needed for the scene. You then show this to as many people as possible and ask them if they can understand the scene. If all or some of the drawings flash past and no one understands the action, give the offending drawings more frames. If your audience does understand what's going on, well done, but make all the drawings play back for a shorter amount of time. Show this to your audience and see if they still understand it. Keep everything as tight as possible. Never be happy with something that will just do. Always keep pushing your audience, keep experimenting with what you can get away with. Having said this, you must allow for movement between your key positions. Err on the side of being slightly too slow. You can always take out the in-betweens later.

Once you have a sequence of key positions that you are happy with, you can then work out how many drawings to do as in-betweens and where they should be placed (mark these up with timing charts at the bottom of every key).

The best way to work out the position of the keys is to act out the movement of your character in front of a mirror. Using a stopwatch to time this is very helpful. If you don't have a stopwatch try saying 'one little monkey, two little monkeys, three little monkeys' ('one little monkey' takes about a second to say,

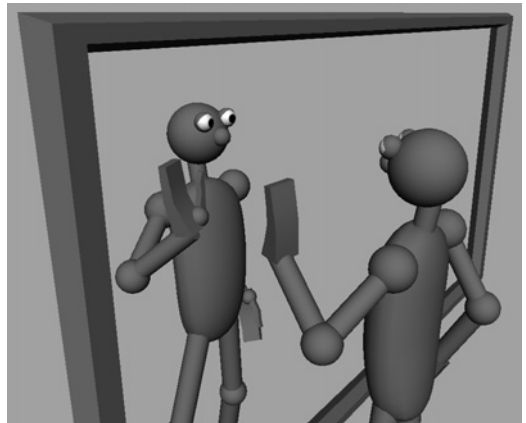

'one little' takes about a half second, so does 'monkey'. 'One', 'little', 'mon' and 'key' take about a quarter of a second each to say). Of course acting out a scene in front of a mirror while saying 'one little monkey, two little monkeys' will make you seriously question your sanity. Don't worry! This is the first part of the process in becoming an animator. Get used to working things out this way. Keep thinking of the minimum that the character needs to physically do in a scene. Never try to fit too much information into too short a period of time. Keep things simple.

As you watch yourself, make thumbnail sketches showing the progression of the movement. This way you don't forget the sequence when you get back to your desk. Act out the scene

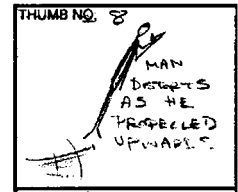
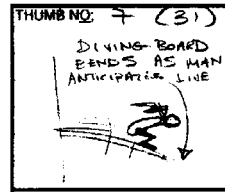
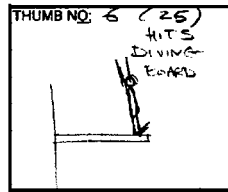
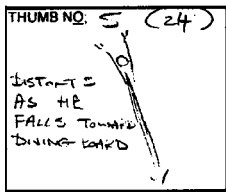
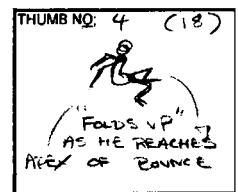
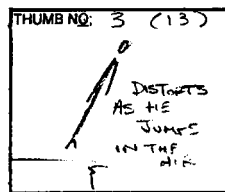
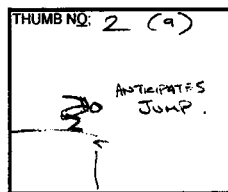
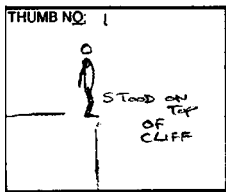

until the movement becomes second nature and you can feel what's happening at all points as you draw or move the scene on your computer.

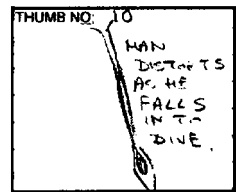
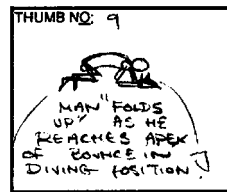

Observing other people acting out a scene, or going about their daily lives will also help with your understanding of timing. Watch people and become familiar with how they're moving and how long it takes them to do certain actions. When you're sat at a table outside a coffee bar or pub, watch the people walking by. When watching them use a stopwatch to time how long an action takes. You could say 'one little monkey, two little monkeys ...' (although not too loud). Also think about what's going through their mind. Are they moving slower because they're depressed or they're contemplative? Are they moving faster in order to get somewhere quickly, or do they need to get away from something?

Timing comes with experience. Experience comes by doing lots of animation and getting it shown to as many people as possible. Don't be afraid of asking for advice, be big enough to take criticism and always think of your audience.

## anticipation

Every action initiated by a living creature (humans, animals or inanimate objects that have a character) will look better if you use an anticipatory move prior to the main move. An anticipatory move is one that precedes the main movement your character will make, and follows a path that is in the opposite direction to that main movement.

Anticipation serves two purposes.

It communicates to the audience that the character is initiating a major movement. It's as if the character is winding itself up prior to making the move.

It alerts the audience to the fact that something is going to happen and makes sure they are looking at the right place on the screen to see that move (it's all very well doing a move that will surprise an audience, but if they are not looking at it they won't see it and consequently won't be surprised).

A few examples of anticipatory moves follow.

If somebody is going to bend down to pick something up, they will make a slight move upwards (in the opposite direction to the main downward movement), before bending over.

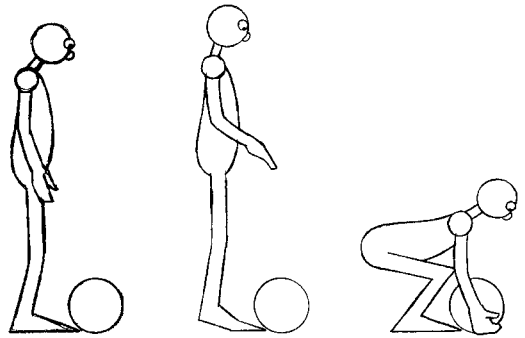

Before walking in one direction, they will pull themselves back (in the opposite direction), before taking the first step.

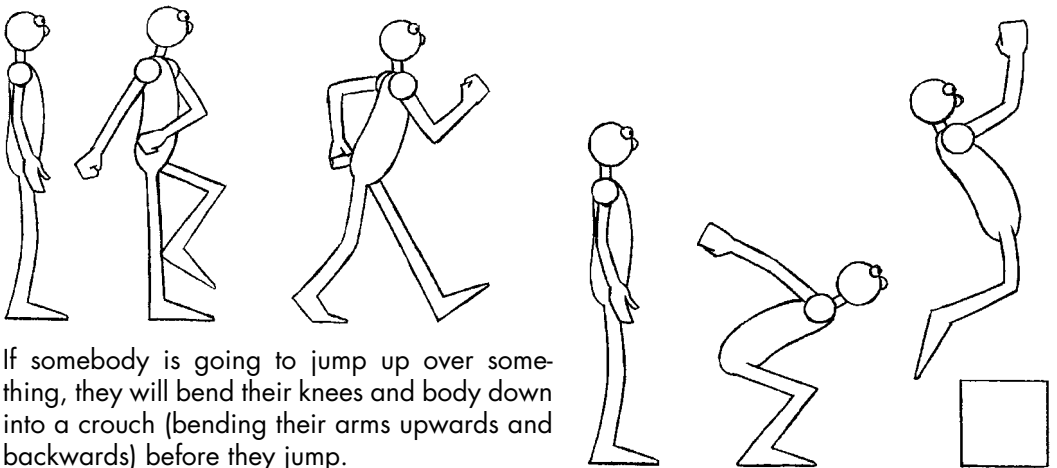

If somebody is going to jump up over something, they will bend their knees and body down into a crouch (bending their arms upwards and backwards) before they jump.

Before throwing something, they will pull their arm back (and lean their body back) in order to put as much energy into the throw as possible.

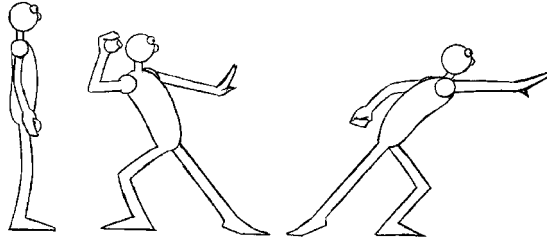

If someone is about to faint and fall to the ground they will straighten up before falling.

If a character is flying through the air and they suddenly fall (Icarus, losing the ability to fly, for example), they will flinch upwards before falling out of screen.

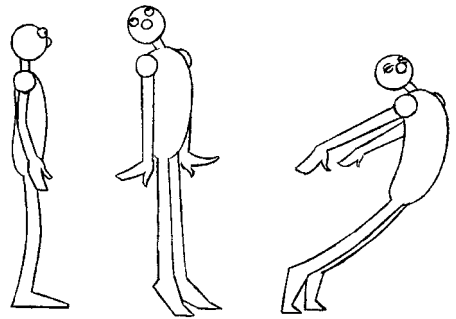

The main occasion that you wouldn't use anticipation is when animating an inanimate object affected by gravity and you don't want to give the impression of the object being alive.



## *how much anticipation*

This depends on a number of factors.

- How much *force* is being put into the move.
- How *fast* the move is.
- How much you want to *surprise* the audience.
- Whether the anticipation is taking place *during a move* or is initiating a *change of direction* during a move.
- It also depends on whether part of the character's body is anticipating the move or the whole body.

## force

These are examples showing how force affects anticipation.

If somebody wants to throw a relatively light ball a long distance, they will lean right back in anticipation of the throw. They will pull back with the ball into the extreme position relatively slowly and accelerate out of the extreme position quickly.

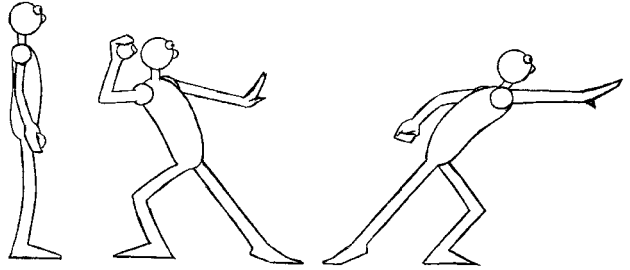

If they were throwing the same ball a short distance, and trying to hit a target with accuracy, the extreme position will not be as far back. They will move slowly backwards into the extreme position and accelerate slowly out of it, making a quick movement at the end of the throw with a flick of the wrist.

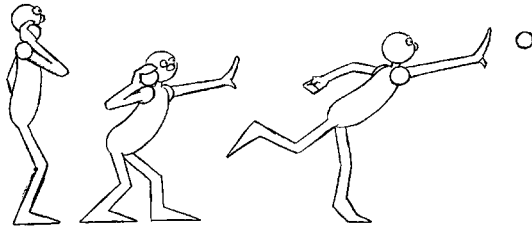
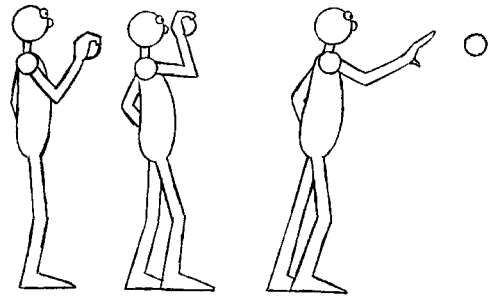

If somebody is trying to throw a heavy ball, they may not be able to lean back very far without unbalancing themselves. In this case the ball would be kept fairly close to the body. The body would be used more in the throw, bending down at the knees and swinging the arms (if they are

both holding the ball), just far enough backwards to prevent themselves from overbalancing. They could perhaps take a step back or part their legs further in order to keep the centre of balance above and between the legs.

When jumping, the weight that the character is trying to move is themselves. A heavier character will need to anticipate more than a lighter character in order to jump in the air!

When jumping upwards the direction of the anticipation is straight down. The higher somebody wants to jump the further down a body will have to crouch in anticipation.

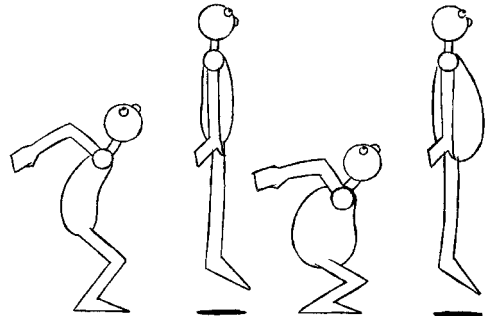

If somebody wants to jump a long distance they will pull themselves backwards and downwards in anticipation. The amount backwards and the

amount downwards depends on the angle at which the character will jump. Anticipating downwards for height and backwards for distance. Rather than keeping the two feet together the legs will take a stride.

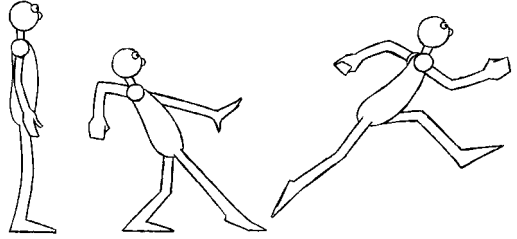

## *acting and anticipation*

When it comes to acting, the way a character moves when changing position will influence how extreme the anticipation is. A slow movement could have a small anticipation. A fast violent move would need a larger anticipation. A sudden movement would barely have any anticipation at all. Added to this is the frame of mind the character is in together with their surrounding environment. Usually there will be an anticipatory position, before or during any move.

One way to carry out this is to have a small anticipatory move of the head in the opposite direction of the major move. Make the eyes move in the direction of the major move first. If a character is going to look screen right, the eyes will look screen right first, while the head does a small anticipatory move to the left. It will then turn to face screen right following an arc.

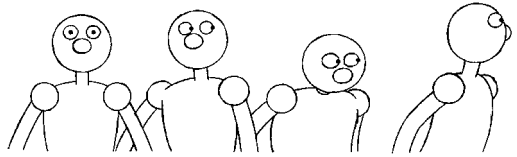

Sometimes anticipation in acting can be as small as a slight roll of the eyes; sometimes it can be as huge as a full-blown double take.

## *double takes!*

The classic example of anticipation is a double take (called this because it involves a character looking at something twice – taking something in twice). This is when a character catches sight of something (perhaps out of the corner of its eye) but does not take in the significance of what it has seen. This first look would be followed by an anticipatory move. This could lead to the character almost screwing themselves up (in the opposite direction to the major or 'take' move). This anticipatory move is followed by the second look. The second look can be as extreme as the eyes popping out of their sockets and a huge mouth with a large wagging tongue. Watch any Tex Avery film if you want to know how to do an over the top double take correctly.



Double takes don't have to be as extreme as this. They can be as subtle as a small nod of the head from the first look to the next. This gives the suggestion that the character has seen something, is slightly surprised by what they've seen and needs to see it again to make sure their eyes are not deceiving them.



## *speed and surprise*

If a movement is quick or is made suddenly, it's best to use a small anticipatory move. Having said that, much depends on the force and the speed of the move. Somebody running fast will start with a big anticipatory move.

To shock your audience with an unexpected action, you may think there would be no anticipatory move. If this was left out the audience could miss the action because they may not be looking at the right place. Have a small and very quick anticipatory move (just enough to catch your audience's eye) and then do your sudden move.

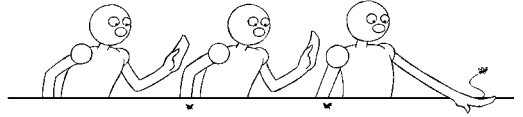

Another way of giving a hint that something is going to happen is to make another part of the body do the anticipatory move. In this example the character is pointing with his right arm. Make its arm move suddenly away from the body. The rest of the body would be thrown back first and then be dragged forward by the arm.

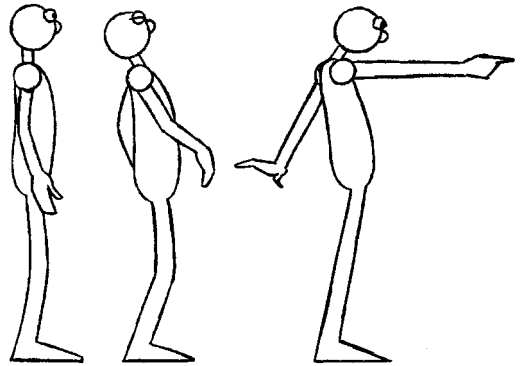

This relative flinging of the body backwards acts as an anticipatory move and gives the audience something to latch onto prior to and during the major move.

## *anticipation during a move*

Anticipatory moves, as with the sudden movement we discussed above, don't have to happen before a move, they can happen during a move as well.

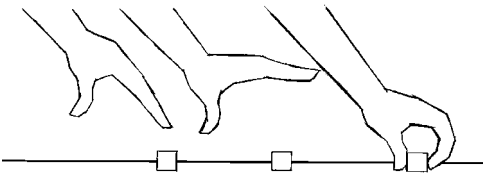

If somebody is moving their arm to pick something up, as the hand approaches the object it may pause and pull back slightly, opening its fingers just before it grabs the object. The arm as a whole is moving all the time, but the hand relative to the arm is moving backwards (anticipatory move) and then forward (major move).

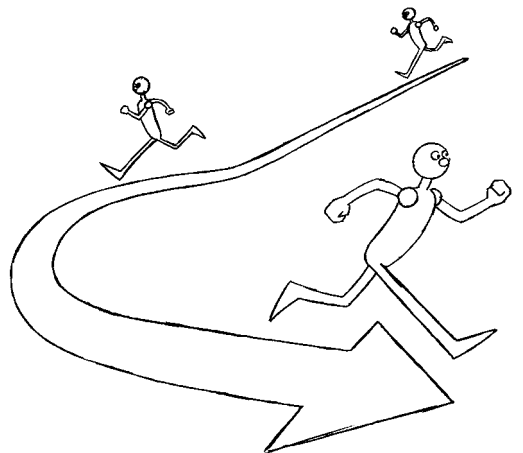

If a character is running and wants to change direction, they could twist away, still running, before executing the main turn. I always think of this in relation to driving a car and making a tight turn. In order to do this you have to initially steer outwards in order to increase your turning circle. The same is true of a four-legged character like a horse or a dog.

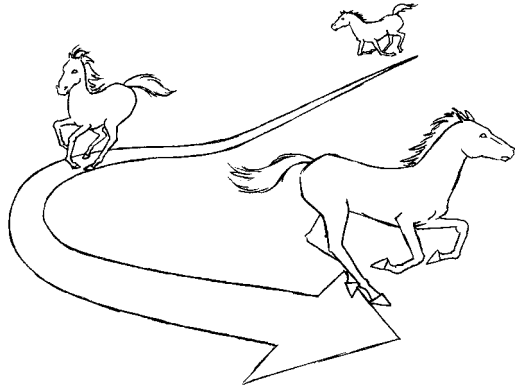

When walking or running around a corner the head will always turn into the corner first followed by the body.

This all helps with creating momentum and it alerts the audience to the fact that the character or animal is going to make a turn.

If a character is tripping up you can always make it look better by having a very slight pause at the first point of the trip (to get the audience wondering whether the tripper will fall over or not). Use a few frames (six to eight), then as gravity takes hold, part of the body (led by the stomach (centre of gravity)) starts to fall toward the ground. Have the arms, the head and the legs thrown back slightly in the opposite direction to the fall before following the rest of the body.

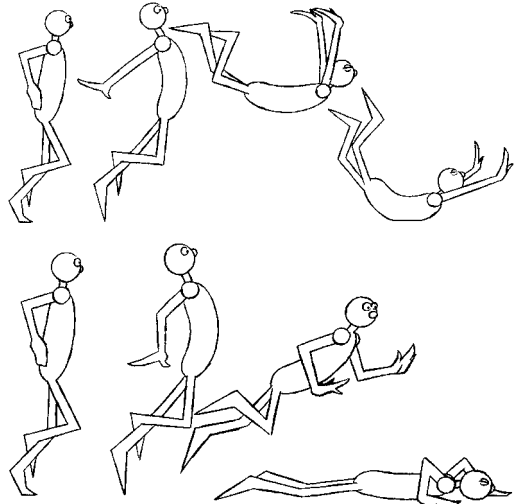

This is a very cartoon like trip and, hopefully, will make an audience laugh. A more naturalistic trip will look something like the illustration. An audience seeing this trip will not laugh, they will go 'ouch'!

### *varying the amount of anticipation*

This is to do with the amount that the body anticipates a given move over its entirety. If a character is going to point with its arm, the arm is going to pull back in anticipation by a large amount. The body will pull back by only a small amount, the head (especially if the character is looking at something intently) may move by an even smaller amount.

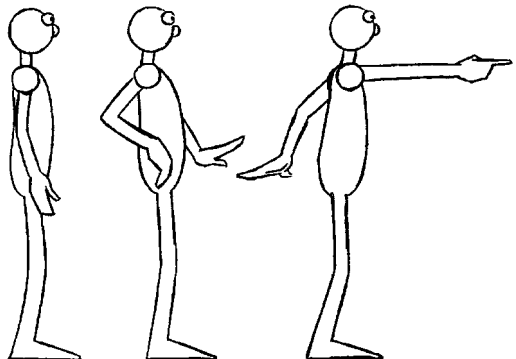

If a character is going to make a move which uses the entire body, then the whole body



will do an anticipatory move. Any variation across the body will be relatively less.

When animating a scene where there will be several anticipations, try to think of different ways of doing each anticipatory movement. If they are all done in the same way your animation will look very mechanical and repetitive.

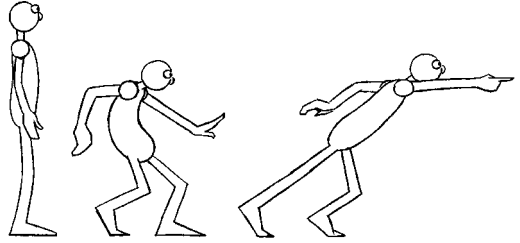

### *other ways of using anticipation*

Anticipation can also be used with special effects animation. When something is struck by lightning, the clouds that generate the flash should light up at different patches. This will let the audience know that something is about to happen. Just before the bolt of lightning appears have a white flash frame.

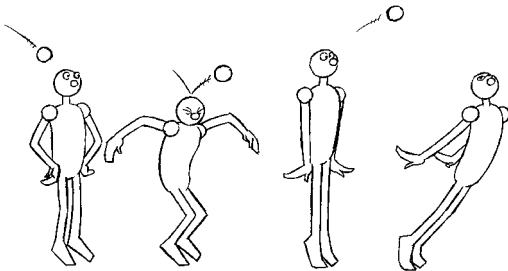
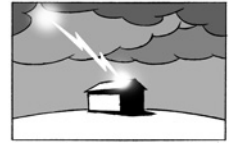

Otherwise the audience misses the bolt of lightning.

Somebody hit on the head by a rock will bounce up straight into the air before falling over, anticipating the fall.

### **follow-through**

When a character initiates a move, follow-through is the movement by additional matter, which follows the major anticipation and overshoot movement. This follow-through movement is made by the extremities of the body, such as hair, ears, tails, etc. and also ancillary items such as clothing and general drapery.

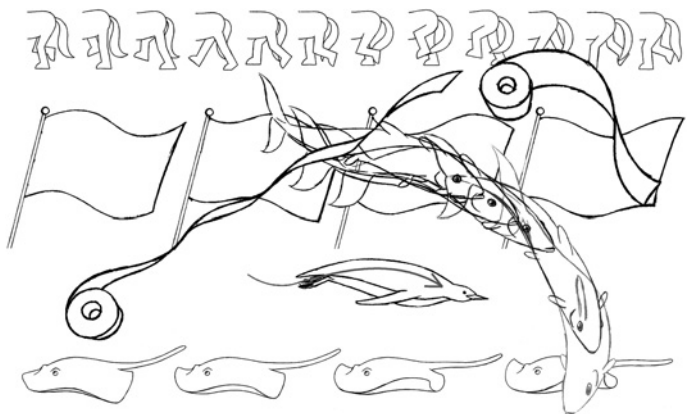

## *follow-through of inanimate objects*

This is the animation of hair, manes, coat tails, ties, sleeves, strings, general drapery, etc.

Generally inanimate objects connected to your character will follow a path similar to the part of the character they are attached to. Depending on the size and flexibility of the object it will flail out from the end of this path to varying degrees.

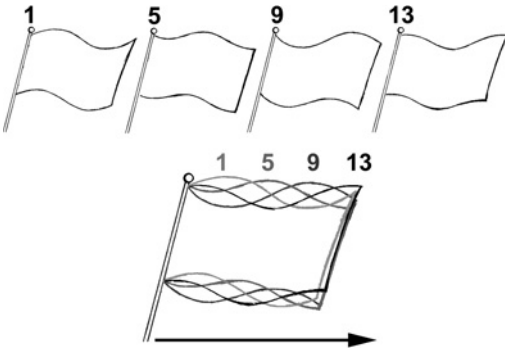

Depending on the stiffness of the object, you will get a slightly different type of follow-through. Generally a piece of drapery will demonstrate a wave running along its length as it is pulled through the air. At its most simple this is like a flag cycle. See [flag\\_cycle.avi](#) chapter004 of the CD-ROM.

A flag cycle consists of a piece of cloth that has a wave running through it. Each crest of the waves on one drawing becomes the crest of wave on the next drawing. The first key drawing (number 5) is the mirror image of the first key position (number 1) and the fourth key drawing (number 13) is the mirror image of the second key drawing. They will then need in-betweening. You should shoot these drawings: 1, 3, 5, 7, 9, 11, 13, 15, 1, 3, 5, 7, 9, 11, 13, 15, etc.

Imagine a piece of cloth being pulled through the air. The cloth will drag behind the point where it is being held by the hand, flailing outwards at the end. If the hand



slows down or stops, the cloth will catch up with the hand and start to move ahead.

A piece of string or rope will act in a similar way but because they have a greater flexibility

than a piece of cloth they will flail out of the path set by the character to a larger degree.

A steel chain will do something similar but will always be affected by its weight falling faster, but not swinging as far.

If the object holding the cloth speeds up, the cloth straightens as it is left behind. Just give it a very tight wave running along its length.

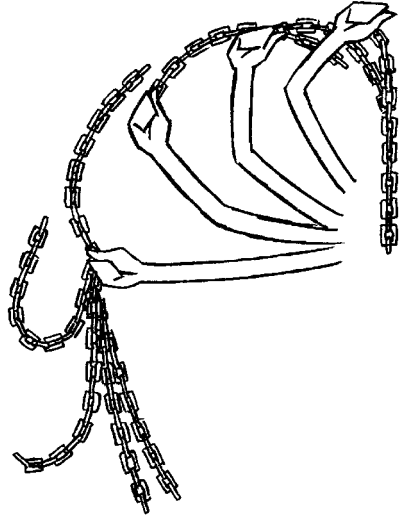
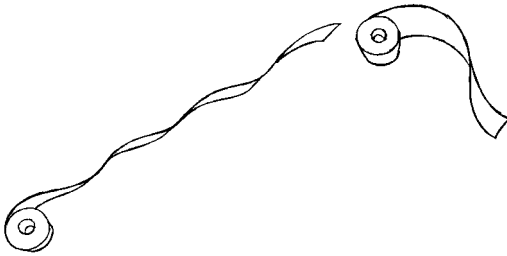

## *follow-through of animate (living) objects*

This is the animation of ears, tails, breasts, beer bellies and to a lesser extent, arms, legs, the neck and head. Anything that at certain times moves loosely on the body.

Rather than following the path of the character, these body parts have a life of their own. They follow the pattern of cloth or string but can be more exaggerated.

Tails are extensions of the backbone and as such have a particular movement. Always think of them as part of the backbone and think of them as resembling a chain of joints.

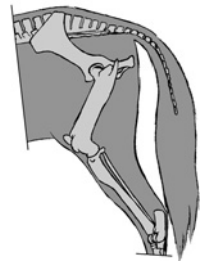
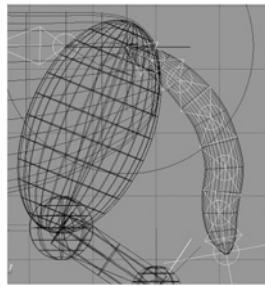
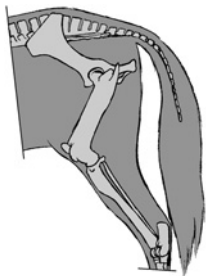

It's worth knowing how much of the tail is backbone as it varies from animal to animal and will affect how the tail moves. A horse's tail is a relatively short stump of bone with a large amount of long hair attached to it. A cat's tail is backbone along its entire length.

In the same way that a piece of string will, to a certain extent, follow a path led by the part of the body that initiates the movement, the same will happen with the tail. This time the movement is led by the animal's bottom.

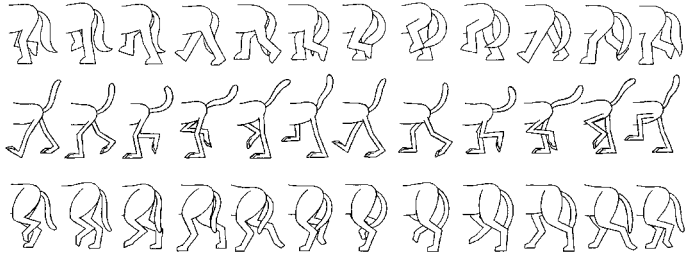

Occasionally the animal will initiate a slight movement through the tail itself. So for most of the time the tail will follow a cycle but occasionally it will give a twitch and do something slightly different. The tail will then return to the cycle.

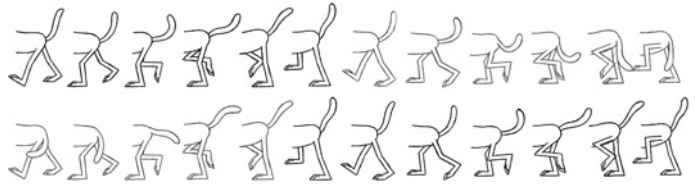

Think about how much of the tail will be following through and how much is initiated from within. Some of the movement is as a result of the animal's bottom moving and some of the movement is as a result of the animal moving the tail.

Ears move slightly differently. As with the tails, the make-up of the ear will vary from animal to animal. This affects the movement during follow-through. With dogs ears for example, a spaniel's ears will move in a much more floppy way than a terrier's ears. This is because a spaniel's ears are larger and softer and a terrier's ears are shorter and stiffer.

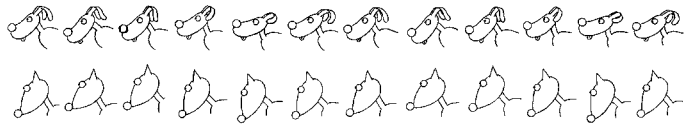

Any sort of hair will move more like an inanimate object, because hair consists of a huge amount of individual strands. On their own they would move like a piece of light string, but collectively they have a firmer quality. It is always a good idea to simplify a clump of hair to an outline with a few individual strands highlighted. To draw every single hair would take a very long time. In 3D whole sections of the animation program are dedicated to the animation of hair and to a certain extent will do a lot of the work for you. It is always a good idea to have some understanding of how hair works.

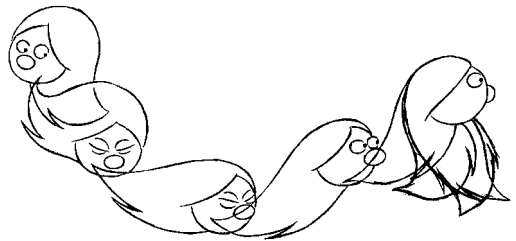

As with the previous examples, the level of follow-through depends on how extreme the movement is. If we take as an example a head moving from side to side; as the head moves from one side, the hair fans out close to the scalp. It then starts to taper towards the tips before pinching up thinner at the extreme of the movement.

With 3D-computer animation it depends how naturalistic you want to be. Keep in mind that the more realistic your design, the more realistic the audience expects it to move.

The limbs of a character will demonstrate follow-through during a movement. The amount of follow-through is dictated by the nature of the action.

An animated arm that accurately follows the true movement of the limb may look ungainly to the audience. When you animate a sequence like this it can look jerky and not flow nicely.

The arm should be re-drawn so that the arm flows with the movement.

To achieve a graceful movement as an arm moves into a resting position may require the bending of

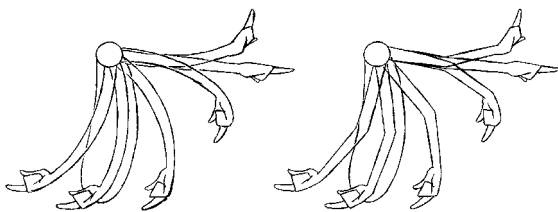
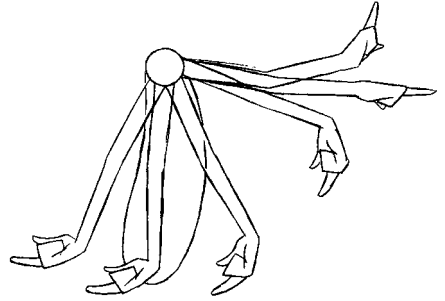

joints into impossible positions. This way of achieving fluidity by cheating is often called the 'breaking of joints'.

Imagine that the arm is a length of rubber hose and will follow-through the movement initiated by the hand. This will look fluid but will also look odd, as

though it has lost the elbow and the wrist joint. To make it more convincing, take this piece of animation but add the elbow and the wrist joint to it. Bend the elbow or wrist joint in such a way that it follows the general bend of our rubbery arm. Don't worry that the joints do something impossible. As long as it moves nicely it doesn't matter!

You can take this idea further when any of the limbs are moving at a very fast speed. The arms can lose their joints altogether and even be distorted along the length of the movement to suggest speed. This is referred to as 'smearing'.

What is happening is that the movement is so fast that each individual shot frame is not fast enough to catch a sharp image of a particular bit of the movement.

A similar thing happens in live action film-making. If you look at the individual frames of a live action

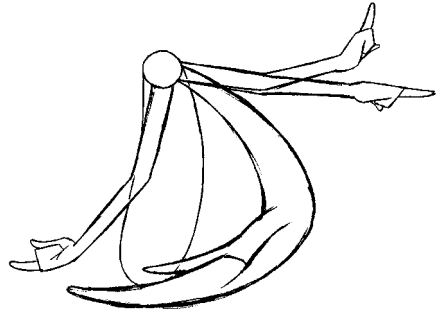

sequence which shows a fast movement, the image will be distorted.

The leading part of the moving limb will be fairly sharp but the trailing part will be blurred. You can replicate this in your animation in a number of ways. These include smearing, adding whiz lines or (in 3D) motion blur.

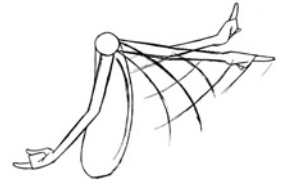

Smearing and whiz lines tend to be more cartoon like, motion blur tends to be more realistic. With all of these techniques they should only be used at the appropriate time. If you use these tricks to slow a movement you end up with a mutant limb. You should never actually see any of these distortions but you should miss them if they are not there. Only ever use them with a fast move.

If a character is moving so fast that they cannot control their limbs, we will get the most distorted follow-through. This will happen, for example, when a character is falling through the air or is being pulled out of screen.

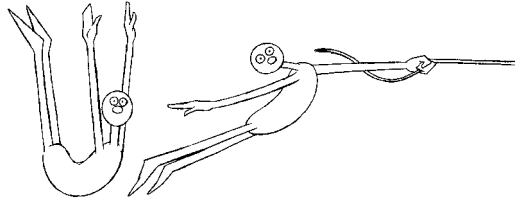

Generally it's always a good idea to animate the follow-through of these parts of a character after you've done the main animation. Follow-through always works better if you animate straight ahead, so take your completed rough animation and put the additional followed-through bits on afterwards.

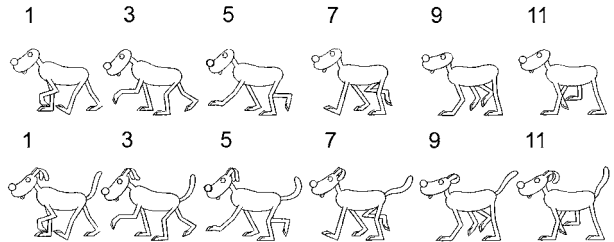

## overlapping action or overshoot

When a character makes a move and then comes to a stop it's always a good idea to make individual parts of that character come to a stop at different times. This gives the impression of a character that is alive. Having a character come to a dead stop makes a character look just that, dead! A good way of doing this is

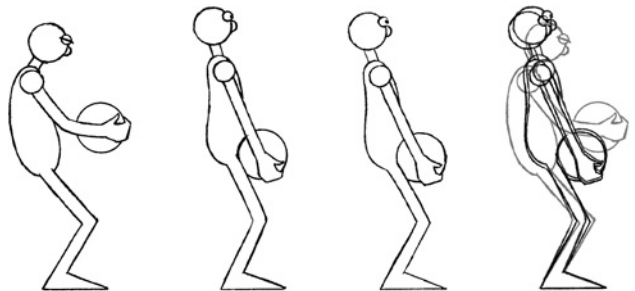

to give your character overlapping action. This means making your character go slightly

beyond the position it will come to a stop in and then going back to this position. It overshoots its final position. A good example of this is at the end of the lift sequence in the last chapter. The character moves upwards after the ball is picked up and then settles down at the end.

For example, when a character lands on the ground after jumping, the legs will bend as the knees take the weight. The arms will 'flow' forward in an arc and be pulled back as the body unbends. The head will be tilted backwards as the body falls and be dragged back up as the body straightens. When the body comes to a stop the head will go slightly beyond its final resting-place and then come back to a stop. This is what overshoot is. Extremities of the body go beyond the body's final resting place and then come back to rest.

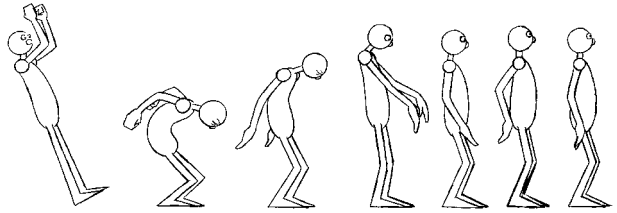

When somebody points, the finger doing the pointing will go slightly beyond its final resting position. You could even lose the joint and make the arm perfectly straight at the most extreme position and try stretching the arm as well.

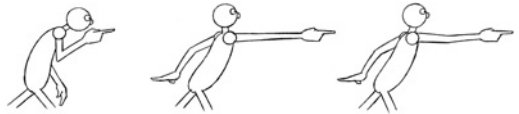

When a head moves from one side to another, it will go slightly beyond its final resting position and then move back to a stop. The hair continues to move, as will the jowls, ear-rings and any other loose items. The hair, being lighter, will go further beyond the stopping position; the ear-rings, being heavier and more solid, will not go as far. The jowls will only go beyond their resting position a small amount before coming to a stop. Both the hair and the jowls will come back to a final resting position but at slightly different times; the hair will come to a stop last.



Drapery will move beyond the character's final resting position and then flow back to a graceful stop.

Making parts of you character come to a stop at different times always improves your animation.

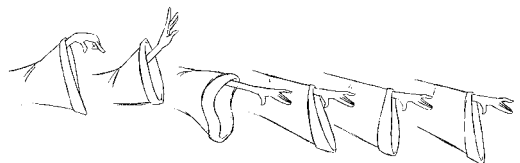

## vibration

When we have a stiff object that can show a small amount of flexibility, like an arrow, a plank of wood or a fishing rod, we will get a certain amount of vibration with its follow-through and overlapping action.

When an object like this comes to a sudden stop or is bent and then released we get a vibrating movement.

To put these drawings on an x-sheet put drawing 1 at frame 1 then drawing 5 at frame 2, drawing 2 at frame 3, drawing 8 at frame 4, drawing 3 at frame 5, drawing 7 at frame 6, drawing 4 at frame 7, drawing 6 at frame 8 and finally drawing 5 at frame 9.

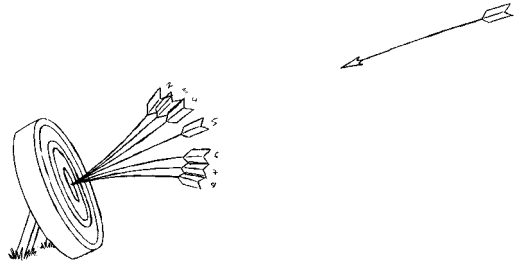
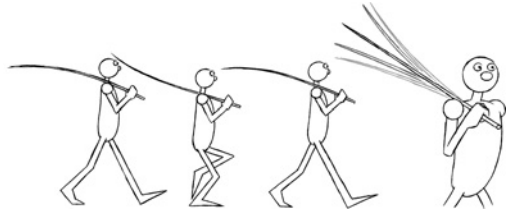

## exercises

### *the string and stick in 2D*

For this exercise we will animate follow-through using a piece of string attached to a stick. Imagine the stick being waved through the air by someone's hand and the string trailing after it. The stick will move forward in an arc, stop and then move back again dragging the string behind it. When the stick reaches the end of its arc, the string overlaps. The stick is then moved through an arc back to the first position, the string being dragged and then overlapping. This action is repeated a second time and then the stick comes to a stop at the same position as frame 1. The piece of string overlaps and comes to a rest. This scene is 100 frames long.

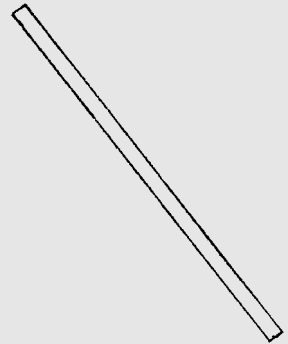

First animate the stick, without the string. For the first key position draw your stick at a jaunty angle.

The stick is going to move forward in an arc to an angle that is a mirror image of the first position. This is key 2. This is at frame 17.

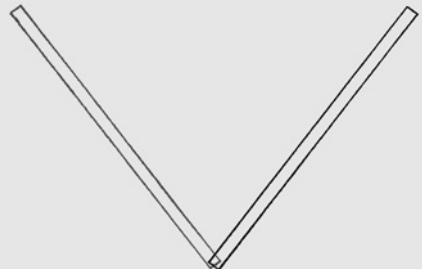

Bring the stick back to the same position as key 1. This is the third key position. This is at frame 33. Draw the stick at the same position as key 2 for the fourth key position. This is at frame 49. Finally



draw the stick at the same position as key 1 for key position 5. This is at frame 65. Have a look at stick\_2D\_keys.avi in chapter004 of the CD-ROM to get the idea.

In-between the key positions by accelerating out of one key position and decelerating into the next.

Have a look at stick\_2D.avi in chapter004 of the CD-ROM. This is the stick waving backwards and forwards.

Now animate the string as 'straight-ahead' animation, drawing on top of your stick drawings. Start with the string hanging down from the end of the stick on frame 1. As the stick moves forward to the next drawing, the string will be pulled forward through the air and will follow-through the shape of the previous drawing.

When the string reaches the second key position (the point where the stick comes to the end of its arc) the string will keep going forward and will be pulled in the opposite direction as the stick moves back through its arc.

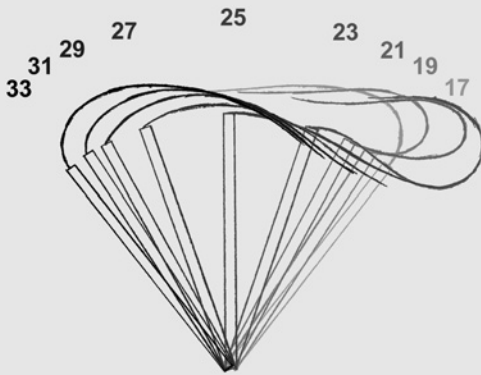

going forward and then be pulled in the opposite direction as the stick moves back through its arc.

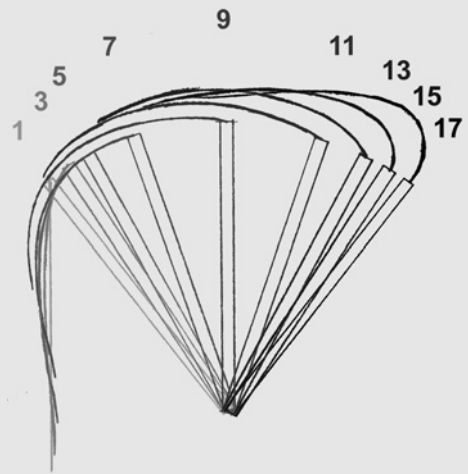
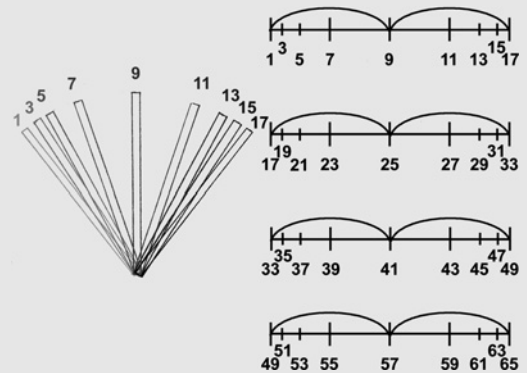

When the stick reaches the end of the second arc (key position 3) the string will keep

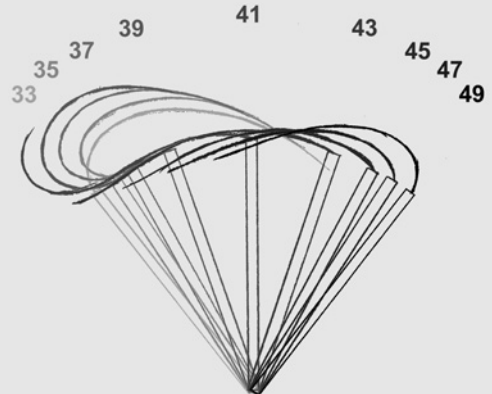

When the stick reaches the end of the third arc (key position 4) the string will keep going forward and then be pulled in the opposite direction as the stick moves back through its arc.

When the stick reaches the end of the fourth arc (key position 5) the string will keep going forward and then be pulled in the opposite direction as the stick moves back through its arc.

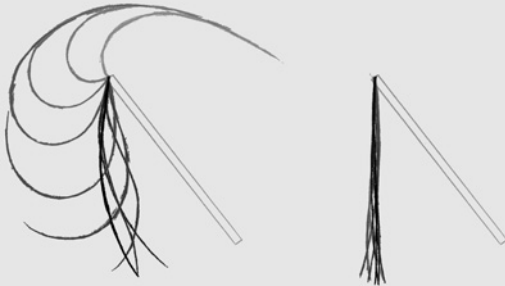
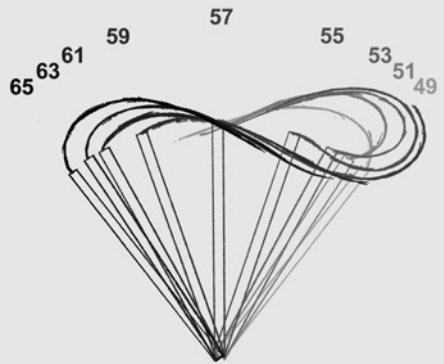

When the stick comes to a stop the string will swing over and sway to a stop.

Take a look at `stick_string_2D.avi` in chapter004 of the CD-ROM.

### *the string and stick in 3D*

First we need to build our stick and string. Create two cylinders, arrange them in a position that resembles the first position of the drawn animation and put bones into them.

This is described in greater detail in the .pdf files; `3DSMAX_stick_string.pdf`, `LightWave_stick_string.pdf`, `Maya_stick_string.pdf` and `XSI_stick_string.pdf` in chapter004 of the CD-ROM.

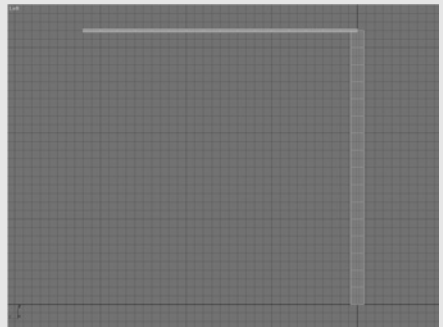

Animate the stick rocking backwards and forwards, then animate the string every other frame at a time, copying the drawn animation (final five illustrations in the 2D exercise).

### *the dive in 2D*

We will animate a character diving off a cliff, then bouncing off a diving board and finally splashing into the sea. This scene is 70 frames long.

During this scene the diver is distorted on certain frames to emphasize the movement. The diver

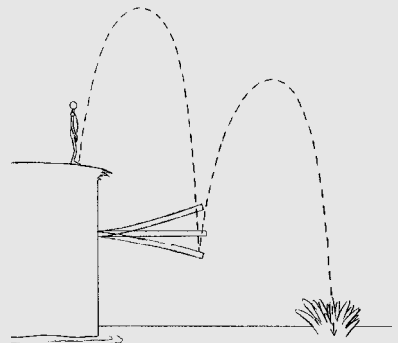

should never be distorted for more than one frame at a time and only at the fastest point of any move.

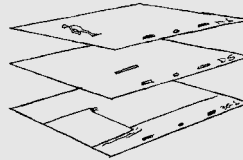

| LEVELS |   |   |   |   |   |   |   |   |   |
|--------|---|---|---|---|---|---|---|---|---|
| FRM NO | 1 | 2 | 3 | 4 | 5 | 6 | 7 | 8 | 9 |
| 1      |   |   |   |   |   |   |   |   |   |
| 2      |   |   |   |   |   |   |   |   |   |
| 3      |   |   |   |   |   |   |   |   |   |
| 4      |   |   |   |   |   |   |   |   |   |
| 5      |   |   |   |   |   |   |   |   |   |
| 6      |   |   |   |   |   |   |   |   |   |
| 7      |   |   |   |   |   |   |   |   |   |
| 8      |   |   |   |   |   |   |   |   |   |
| 9      |   |   |   |   |   |   |   |   |   |
| 10     |   |   |   |   |   |   |   |   |   |

First draw your background on a piece of paper. Use the one above for reference. On a separate piece of paper draw the diving board. This will animate when the diver hits it, but will remain still at the start of the scene. Drawing it on a separate sheet will save you having to draw it on every diver drawing.

When it comes to putting this information on an x-sheet. The background will be on the lowest layer (call it BG1), the diving board is on the middle layer (these will be called drawings D1 to D9) and the diver is on the top layer (call these drawings M1 to M59).

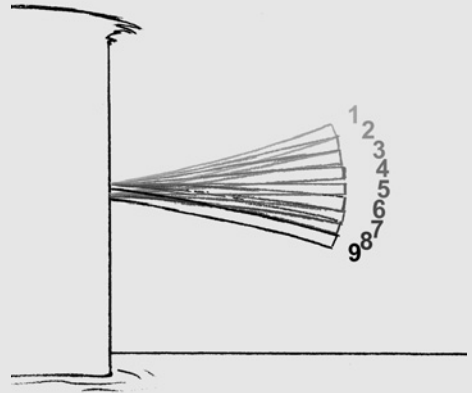

Draw and number the diving board as in the next illustration. The drawings are numbered by the drawing instead of the frame. Have diving board number D5 at the start of the scene (the straight diving board).

Start by drawing the key frames first. In the following illustrations I've included the breakdown positions (the major in-betweens) as well. Do these after you've drawn all the key positions.

Have your diver stand at the top of the cliff and anticipate into the jump. The character

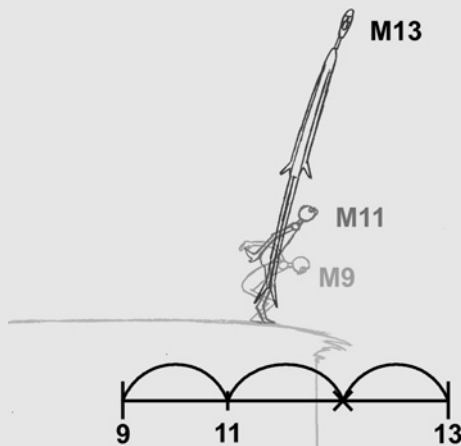
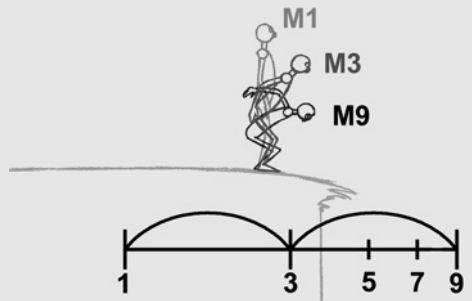

bends down and throws their arms out the back. These are key positions one and two that are at frames 1 and 9 with the breakdown (the major in-between) at frame 3.

When our diver takes off, distort the character as far as you possibly can up to the apex

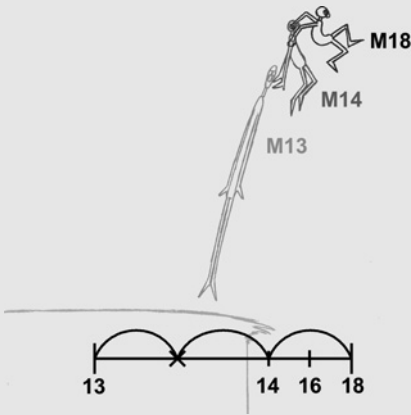

of the jump. At the apex have our character regain his original shape. These are the second and third key positions at frames 9 and 13 with the breakdown on frame 11.

The diver follows an arc through the air similar to the balls we animated in Chapter 2. These are the third and fourth key positions at frames

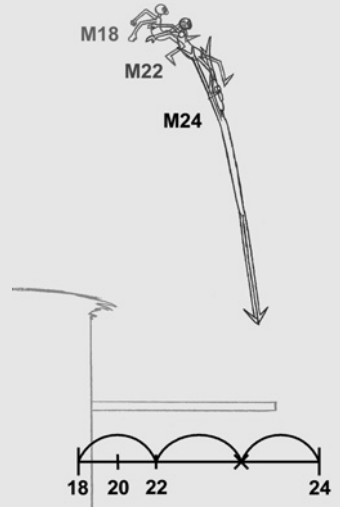

13 and 18, the breakdown being at frame 14.

As our diver falls, make the character distort again in the direction of the fall before the diving board is hit. These are the fourth and fifth key positions at frames 18 and 24 with the breakdown at frame 22.

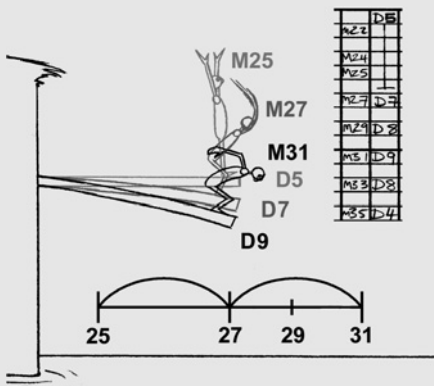

The diving board will bend as it is hit. At this point the diving board will move with the diver. These are the sixth and seventh key positions at frames 25 and 31. The breakdown position is at frame 27. Diving board D5 goes with diver

M25, D7 goes with M27, D8 goes with M29 and D9 goes with M31.

After the diving board bends down, the diver will bounce up from the board and be stretched along the second arc of his dive. These are the seventh and eighth key positions and are at frames 31 and 35. The

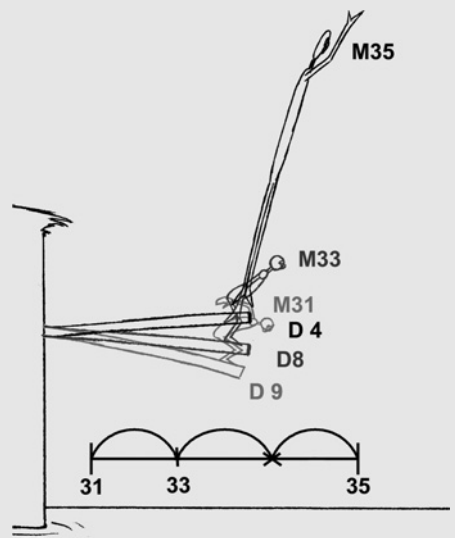

breakdown position is at 33. Diving board D9 goes with diver M31, D8 goes with M33 and D4 goes with M35.

At the apex of this arc the character will slow down and regain his shape. These are the eighth and ninth key positions at frames 35 and 40, the breakdown position being at frame 36. D4 goes with M35, D1 goes with M36 and D1 goes with M40.

The diver will then fall into the water distorting at the fastest point. These are the ninth and tenth key positions and are at frames 40 and 46, the breakdown position is at frame 44. D9 goes with M40, D3 goes with M44 and D3 goes with M46.

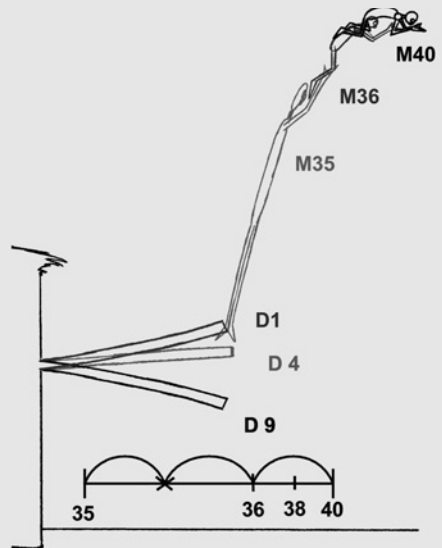

Then there will be a splash as the diver falls into the water.

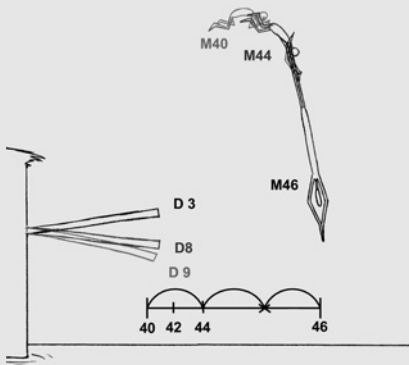

The diving board will then vibrate to a stop. Draw the following positions and then shoot them in the order shown.

This will produce the effect of the diving board vibrating and gradually coming to a stop.

When you've completed all of these key positions, try shooting them with your line tester. I've included the rough timing and the timing charts with this exercise.

Take a look at dive\_2D\_keys.avi in chapter004 of the CD-ROM.

|    |    |    |    |
|----|----|----|----|
| 24 | 24 | 25 | 1  |
| 25 | 25 | 26 | 1  |
| 26 |    |    |    |
| 27 | 27 | 28 | 1  |
| 28 |    |    |    |
| 29 | 29 | 30 | 2  |
| 30 |    |    |    |
| 31 | 31 | 32 | 3  |
| 32 |    |    |    |
| 33 | 33 | 34 | 4  |
| 34 |    |    |    |
| 35 | 35 | 36 | 5  |
| 36 | 36 | 37 | 6  |
| 37 |    |    |    |
| 38 | 38 | 39 | 7  |
| 39 |    |    |    |
| 40 | 40 | 41 | 8  |
| 41 |    |    |    |
| 42 | 42 | 43 | 9  |
| 43 |    |    |    |
| 44 | 44 | 45 | 10 |
| 45 |    |    |    |
| 46 | 46 | 47 | 11 |
| 47 |    |    |    |
| 48 | 48 | 49 | 12 |
| 49 |    |    |    |
| 50 |    |    |    |
| 51 | 51 | 52 | 13 |
| 52 |    |    |    |
| 53 | 53 | 54 | 14 |
| 54 |    |    |    |
| 55 | 55 | 56 | 15 |
| 56 |    |    |    |
| 57 | 57 | 58 | 16 |
| 58 |    |    |    |
| 59 | 59 | 60 | 17 |
| 60 |    |    |    |

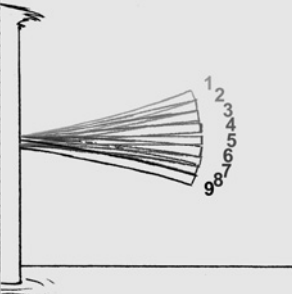

You could also take a look at my rough x-sheet called `dive_x-sheet_1.pdf` or `dive_x-sheet_1.jpg` and `dive_x-sheet_2.pdf` or `dive_x-sheet_2.jpg` in chapter004 of the CD-ROM.

Once the key animation looks OK, in-between the keys, following the timing charts. Do the breakdowns first and then the in-betweens. Make sure that the character's body returns to its proper shape immediately before and after the points at which it's distorted.

Take a look at `dive_2D.avi` in chapter004 of the CD-ROM.

When you're happy with your drawn version have a go in 3D!

### *the dive in 3D*

For this follow the sequence below.

- We need to build a cliff, a diving board and the sea.
- We then place our character at the top of the cliff.
- Animate the character through the key positions.
- Get the diving board to vibrate.
- Finally distort the character at the necessary frames.

As a guide it helps to put in some nulls (or any other non-rendering objects) at the apex of each bounce and at the point where the character hits the water. When you are zooming in and out of the scene and animating at the same time you can refer to these objects.

For the key positions follow your drawn animation (illustrations for key 2 to key 9 following), but when sorting out the keys don't put in any distortion of the body at frames 18, 24, 35 and 46. Just move the

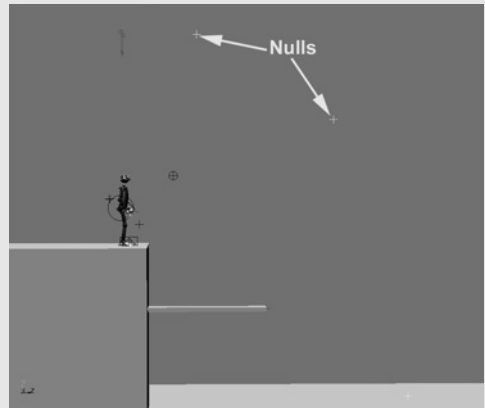
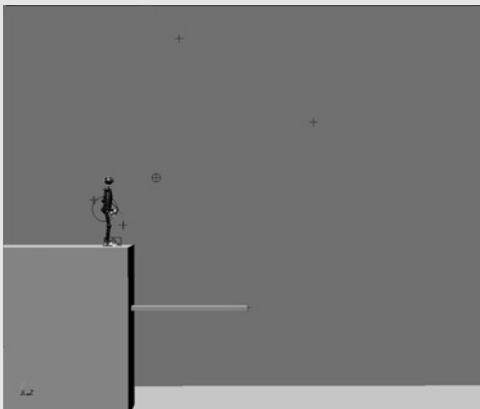

character to a rough approximation of the distorted position.

At key position 1 (frame 1) we need to have our character standing at the top of the cliff in a relaxed pose.

At key 2 (frame 9), the character bends down into the anticipation position of the jump.

Key 3 (frame 13) is the position where the character is distorted on the way up to the apex of the first bounce. When just putting in the key positions we want to move the body to a point halfway between the character's anticipation position at frame 9 and the apex of the first bounce, without any distortion.

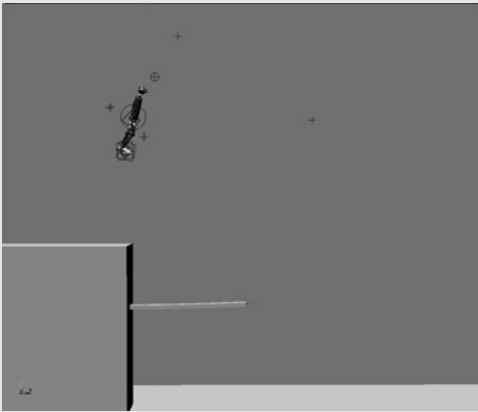
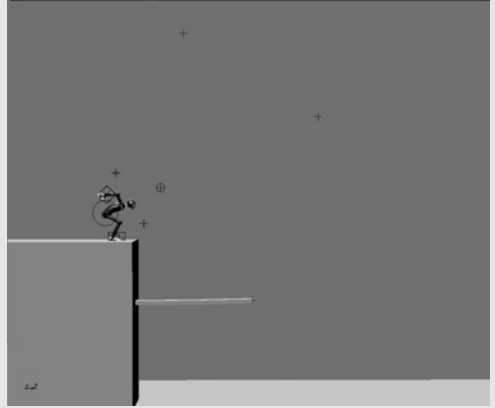

At key 4 (frame 18) the character is at the apex of the bounce. Move him into the same position as the fourth drawn key position (drawing number 18).



At key 5 (frame 24) the key position should be distorted but, as for key 3, just move the character to a rough approximation of the correct position.

At key 6 (frame 25) the character first comes into contact with the diving board. Move the character down to a point where his heels are just touching the board.

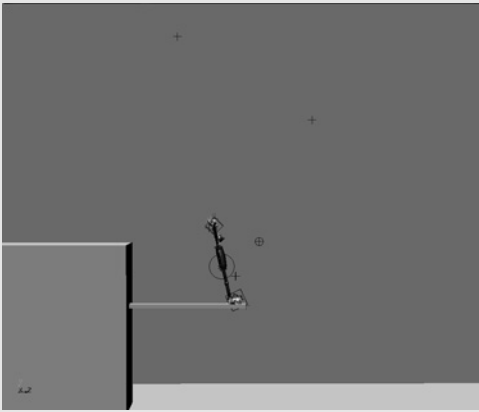

At key 8 (frame 35) the character should be distorted on his way up to the apex of the second bounce. At the moment put the

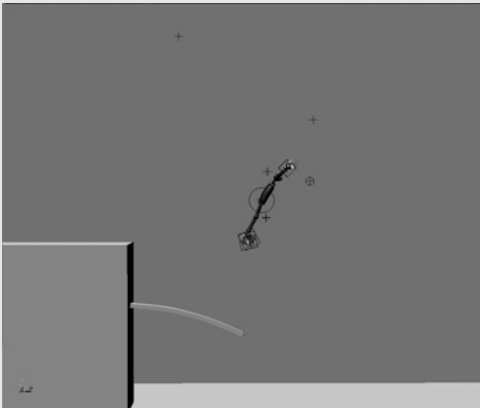

Key 10 (frame 46) is where the character distorts as he falls towards the water. Position our character undistorted into this position.

Key 11 (frame 47) is where the character has hit the water.

Once the key positions are done it's time to sort out the details like putting in the break-down positions, distorting the character at

Select all the bones in the diving board and set a rotation key.

At key 7 (frame 31) bend the diving board by rotating each of the bones in the hierarchy progressively more so that you get something that looks like the drawn animation. Then move our character down into an anticipation position.

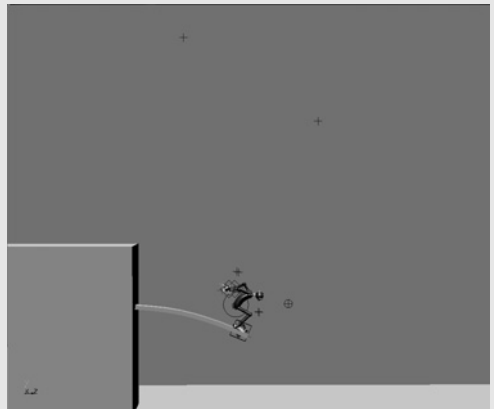

character in a position that approximates this position undistorted.

Key 9 (frame 40) is the apex of the second bounce so position the character curled up with its arms in a diving position.

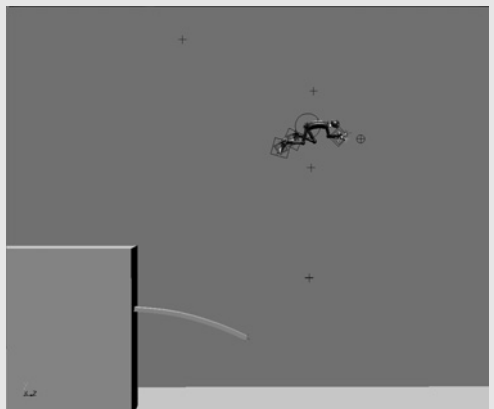



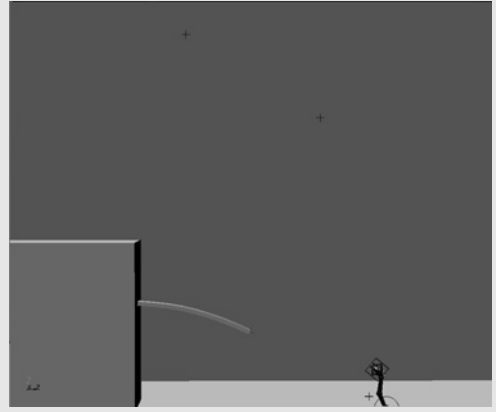
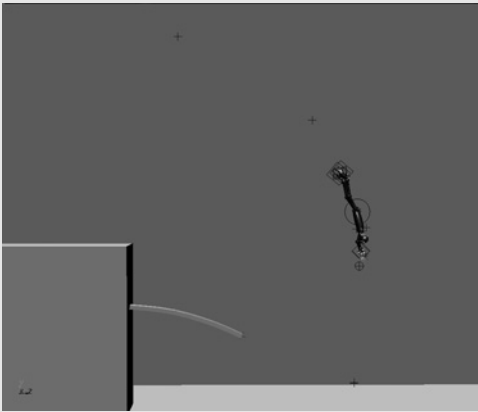

frames 18, 24, 35 and 46 and making the diving board vibrate. All the four programs do this in a slightly different way.

This is described in greater detail in the .pdf files 3DSMAX\_dive.pdf, LightWave\_dive.pdf, Maya\_dive.pdf and XSI\_dive.pdf in chapter004 of the CD-ROM.

## chapter 5

# human walks and runs

### chapter summary

- *walk cycles!*
- *walking*  
*pace*
- *walking mechanics*  
*the four basic positions of a walk*  
*the stride positions*  
*the cross over positions*  
*shoulder movement*  
*arm movement*  
*up and down movement of the body*
- *walk cycles displaying different moods*
- *external influences*
- *two people walking together*
- *running*
- *exercises*  
*walk or run cycle in 2D*  
*walk or run cycle in 3D*  
*changing the pace and mood in a walk in 2D*  
*changing the pace and mood in a walk in 3D*

A human walk can be a difficult sequence to animate believably. This is because your audience are walking experts! They have been walking since they were about a year old and see people walking around them all the time. Consequently they can judge whether your walk is convincing. If it's not so good they stop believing in your character.

## walk cycles!

A walk cycle is a piece of animation where a character walks on the spot (similar to walking on a treadmill) and the background pans past them. It consists of two strides that are repeated.

The one thing to remember about walk cycles is that they are by nature repetitive. When we see someone walking along, we are observing a living, breathing person, who is taking in the world around him or her. What we see when watching a walk cycle are the thoughts and actions of the character during those two strides, repeated continually. Consequently, when you animate a walk cycle of somebody in a certain mood, it can seem false, over the top or repetitive.

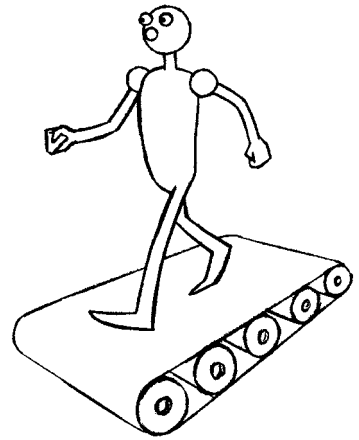

I've found that walk cycles tend to work better if you make them slightly stylized. I think this is because if you deliberately make the design more artificial, your audience will forgive the artificial movement. The more realistic you make an animated character, the more the audience expects it to move in a realistic way.

Take a look at `stylised_walk.avi` in chapter005 of the CD-ROM.

Walk cycles tend to be used in TV series and computer games. The reason for this is that a walk cycle produces a lot of screen time for a small amount of work (and money).

You rarely see walk cycles in feature films. In a feature film an animator will usually animate a character walking from A to B in its entirety. This will produce a walk that is more believable. Only background characters will be doing any form of cycle in a feature film.

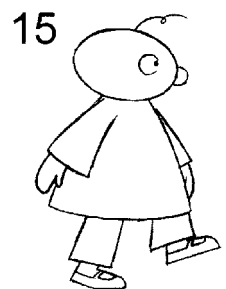
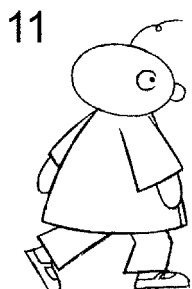
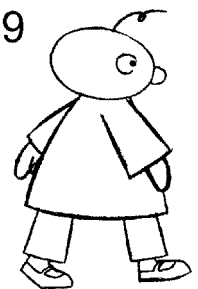
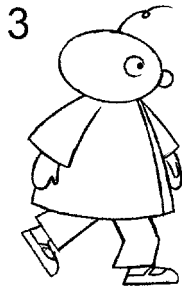
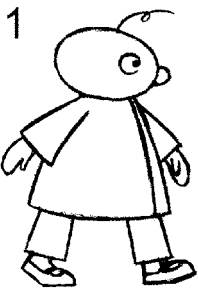

## walking

When animating a character walking from A to B we have to take the following into account.

### pace

Everybody has a natural pace they are comfortable walking at. Think of the pace of your character's walk as the amount of frames it takes for that character to take one stride.

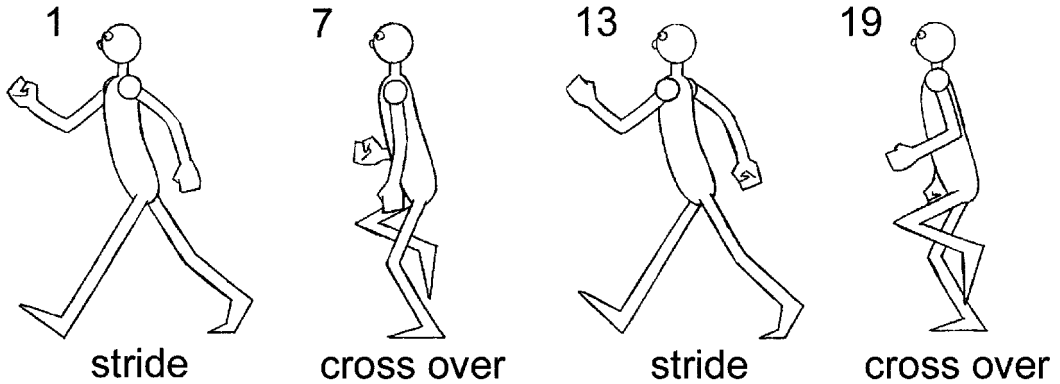

A walk cycle will consist of two major key positions. These are referred to as the stride positions, each with a different leg leading. The breakdown (major in-between) positions between these keys are referred to as the cross over positions. This is where the trailing leg is picked up and crosses over to be placed in front of the (previously) leading leg. Most people take a stride about every half a second. So at 25 frames per second, that's a stride every 10 to 16 frames.

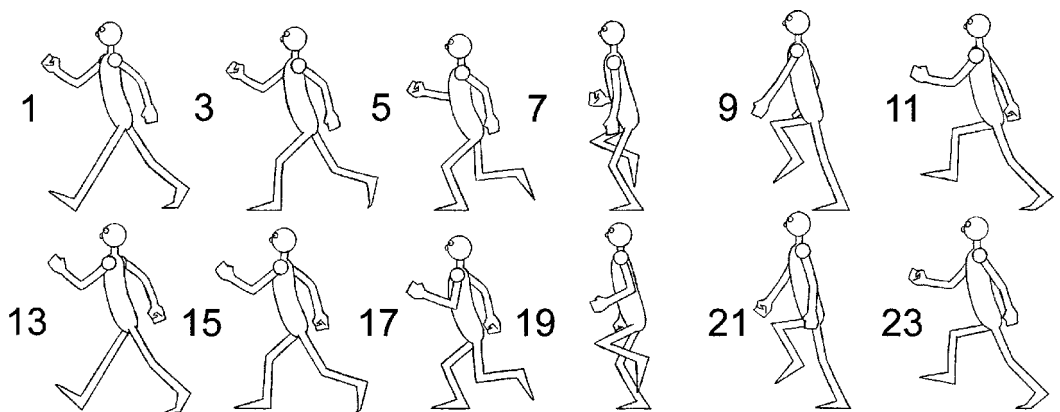

The pace of each stride varies depending on many outside influences. As they are strolling along someone's walking speed will change. It can be affected by the things they see and obstacles they have to negotiate or whether they are on their own or are in company. Frame of mind will also contribute – if they are feeling happy or sad or one of a million other moods.

Remember that all the joints of your character will move in arcs in relation to each other.

Take a look at *basic\_walk\_2D.avi* in chapter005 of the CD-ROM.

When a character slows down or speeds up during a walk the same pace, of around half a second a stride, will be maintained. A character slows down by making the stride shorter and speeds up by making the stride longer. They will still be making each stride roughly every half a second.

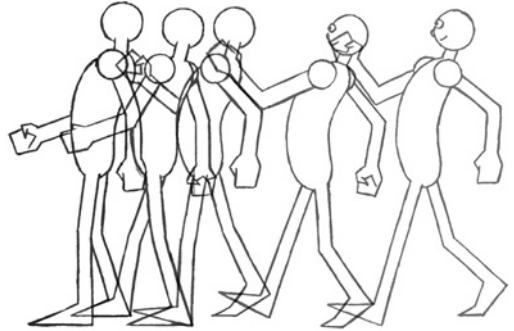

## walking mechanics

### *the four basic positions of a walk*

These are the two stride positions and the two cross over positions.

### *the stride positions*

The two basic keys of a walk are at the extremes of each stride. To complete a walk cycle you need two strides. The exact arm and leg positions will be dependent on the emotions of your character and the external influences being forced on them. However, one thing that is generally true of these 'stride' keys is that the shoulder of the leading arm will be twisted forward of the shoulder of the trailing arm. The hip joint of the leading leg will be twisted forward of the hip joint of the trailing leg. Opposite shoulders and hips lead.

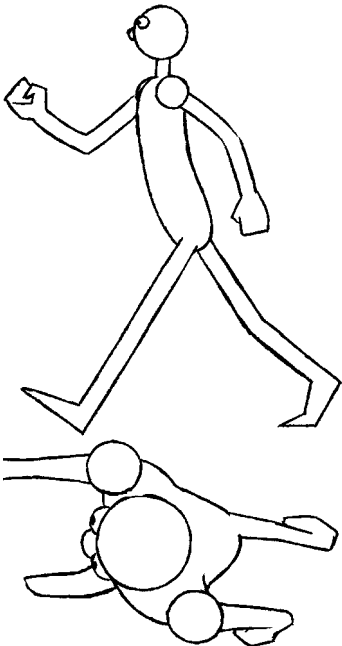

A large amount of the twisting that is happening in the body is occurring at the base of the spine. This is the most flexible part of the spinal column.

The twisting of the shoulders is dealt with by the movement of the shoulder blade and the collar-bone. This will push the shoulder joint of the arm forward or backward in order to balance the top part of the body.



The hips twist in the opposite direction to the shoulders, the leading hip being attached to the leg that is forward.

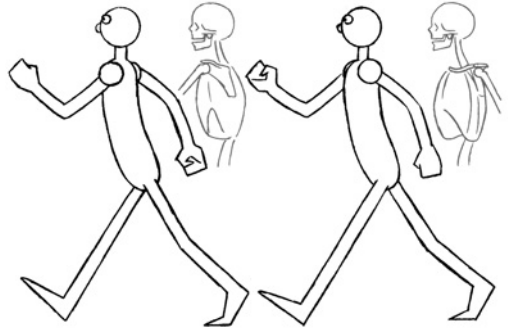
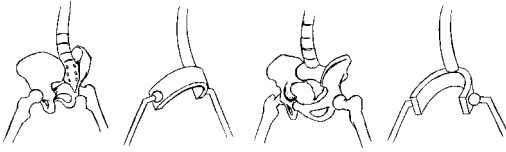

The angle of the hip at this stride position can help put over an idea of the mood of your character.

If the hip is angled with the leading hip higher than the trailing hip, this throws the backbone back and increases the curve in the small of the back. This gives a positive feel to the way your character holds itself. Moods such as happy, determined and laid back will have a hip positioned like this at the stride position.

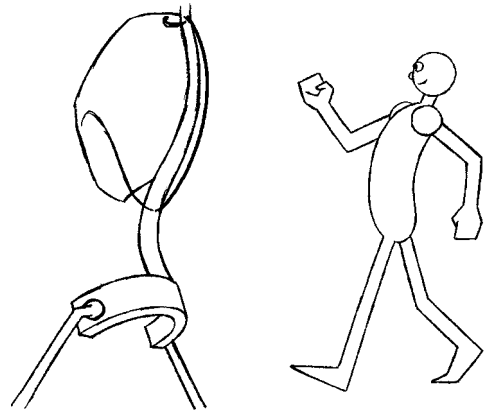

If the angle of the hip has the trailing hip higher and the leading hip lower, you get a curving of the spine forward which gives a negative angle to the body. Depression, misery, goofiness and tiredness are suggested by this hip angle.

Of course there are lots of other things that will suggest the mood of your character (which we'll go into later), but the angle of the hips and the body give the basics of emotion in a walk.

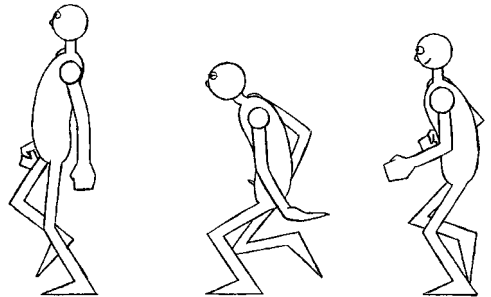

### *the cross over positions*

The breakdowns to sort out are the cross over positions. These are the drawings where the

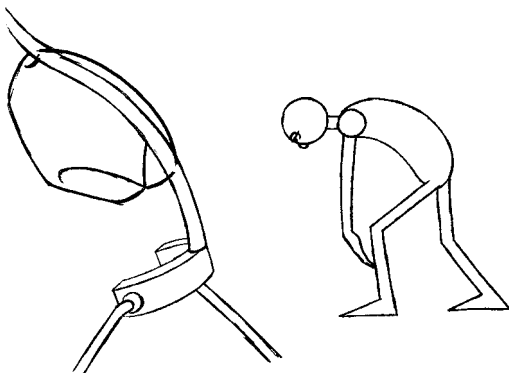

raised leg crosses over in front of or behind the leg that is still in contact with the ground.

A leg that is picked up high during the cross over looks light. The hip of the raised leg will be higher than the other hip.

These are the key drawings that give the audience a clue to the character and mood of your animation. A leg that drags along the ground when crossing over looks heavy. The hip connected to the raised leg would be lower than the hip of the leg touching the ground.

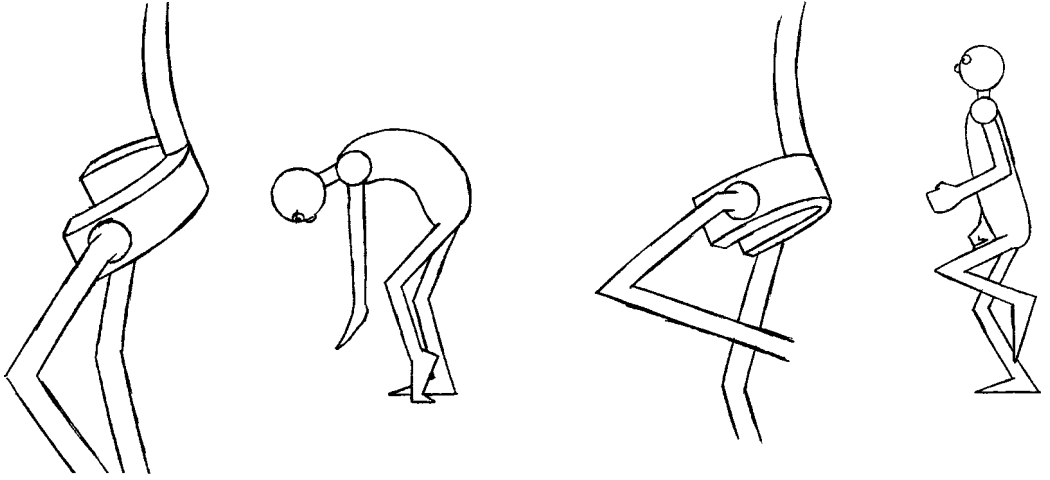

## shoulder movement

With the stride key drawings, the shoulder opposite to the leading leg will be forward. The other shoulder will be trailing. Because the shoulders can move independently of each other, the leading shoulder can be higher, lower or level with the trailing shoulder.

If the leading shoulder is angled higher than the trailing shoulder, this makes the top part of the body look as if it is pulled back. This gives an upbeat, positive feel.

If the leading shoulder is lower than the trailing shoulder, you give more direction to the top of the body. It gives determination to the character. The character is leaning towards what it's walking to.

How you draw the cross over key positions for the shoulders will also give a guide to character.

The shoulder of the arm coming forward moves up (in an arc) and the shoulder of the arm travelling back moves down (also in an arc) (creating a rolling of the shoulders towards the front of the body). This gives the impression of someone who is pushy, determined and knows what they want. A bit of a gangster's walk. The effort is being put into pushing the arms forward.

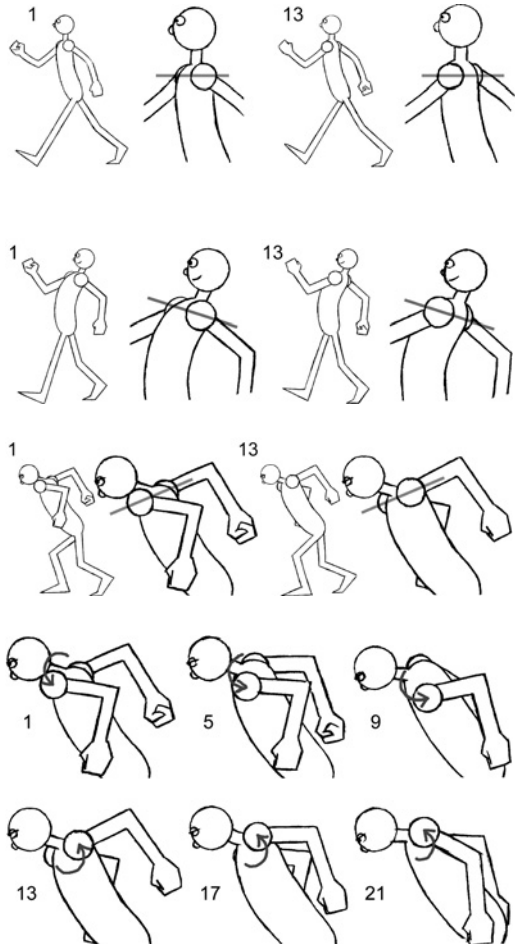

The shoulder of the arm that is moving forward dips down (in an arc) and the shoulder of the arm that is travelling back moves up (in an arc) (creating a rolling of the shoulders towards the back of the body). It gives the impression of someone who's happy and positive. The effort is being put into pulling the arms back.

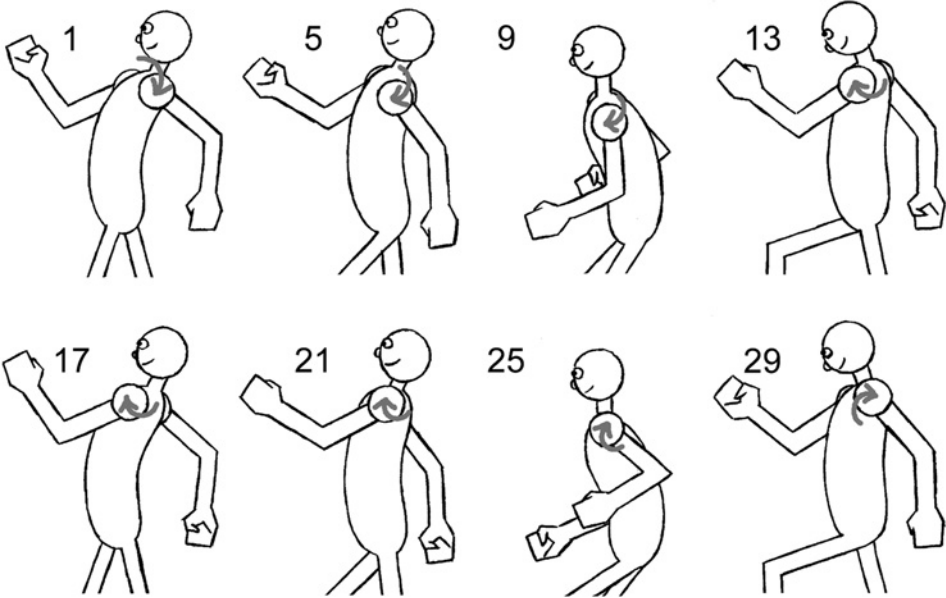

If both shoulders dip down when moving forwards and backwards, it gives the appearance of lethargy and depression.

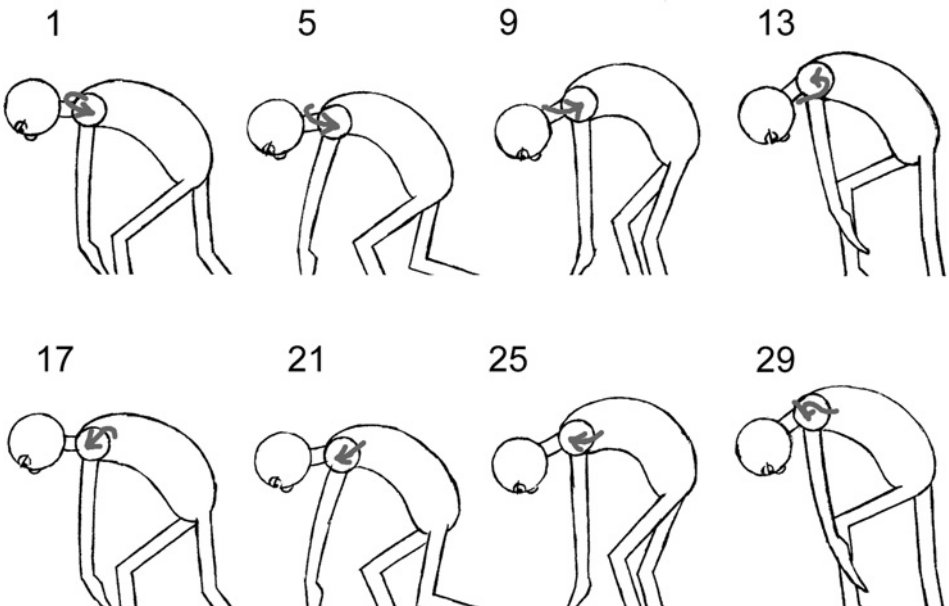



## *arm movement*

At their most basic the arms will swing like a pendulum. They will accelerate out of the extreme positions at the strides, moving fastest when they are near to the body. They will then decelerate as they reach the next extreme position, at the next stride.

The movement of the arms is affected by which joint in the arm is initiating the movement. If the shoulders initiate the movement, the arms will flail out from the shoulders down, following through the movement of the shoulders.

If the elbows initiate the movement, the arms will flail out from the elbows down, following through the movement of the elbows.

If the wrists initiate the movement, the hands will flail out from the wrists down, following through the movement of the wrists.

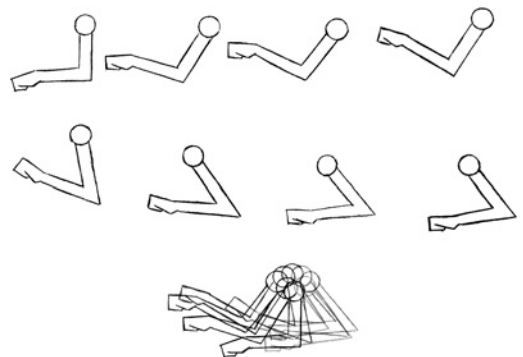
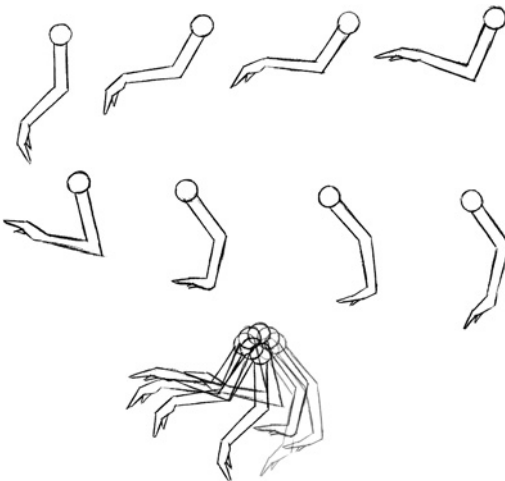
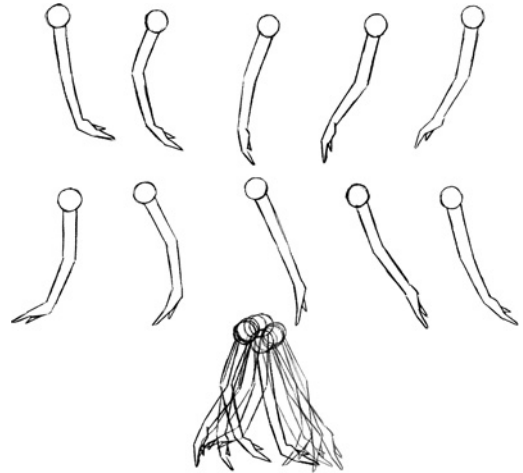
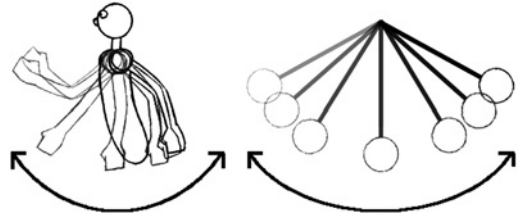

## *up and down movement of the body*

As a person walks, their body bobs up and down. Depending on the mood of your character, this will happen at different places.

During a basic walk the body will bob down at the point when all the weight goes on to the one foot. It will lift up at the point where the foot is brought over, between the cross over position and the stride position.

Making the highest point of the walk at the cross over will give a resentful depressed negative feeling. Animating the cross over at the lowest point of a walk will make the body bounce up and down further and give a more positive feel.

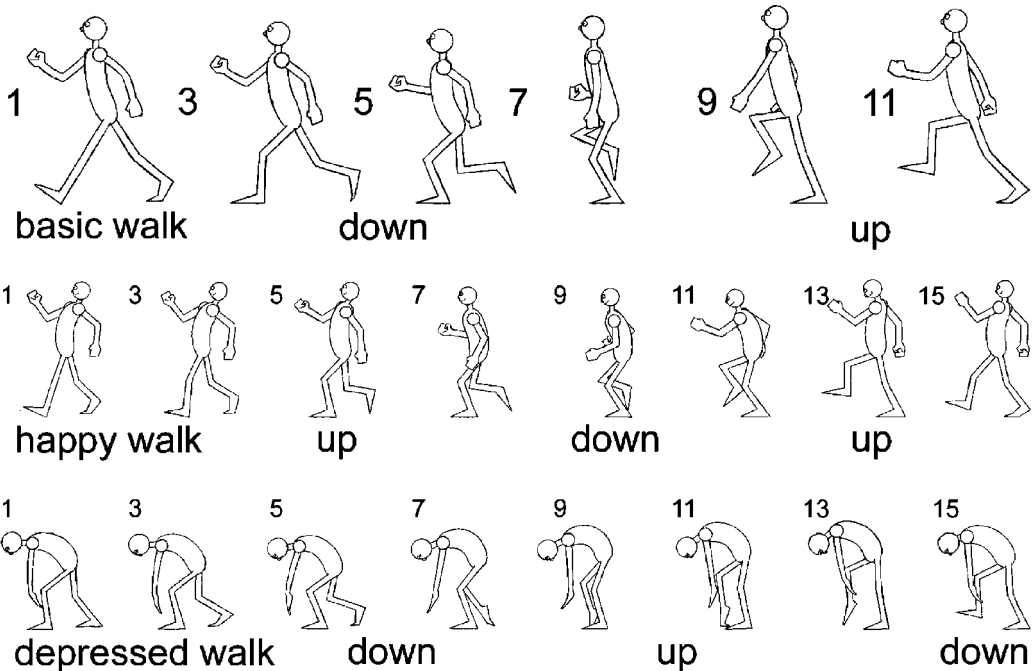

## walk cycles displaying different moods

It has to be emphasized that all the following examples of walks are stereotypes and as such are at the extreme cartoon end of the animation spectrum. The reason why I give these examples is that it is usually better to exaggerate real life, in order for your animation to look more convincing. If you try and make the animation look naturalistic (especially when you are learning to animate) it always ends up looking stiff and wooden. It's better to think of all your animation as having more in common with theatrical stage acting than with real life. When animating I've often found that it's better to 'ham up' a scene at first and then go back and tone the animation down if it's too over the top (it rarely is too over the top).

The mood or character of a person will affect the way they walk. If a person is depressed they will drag their feet and slouch forward with droopy shoulders. Their inner turmoil will result in them putting as little effort into their forward progression as possible so they can

concentrate on being depressed. Every move is an effort. A good depressed face and a head hung low will be the main sign to an audience of what is going on in the head of your character. The shoulders follow up and down arcs (the shoulder is at its highest point at each stride). Have a look at `depressed_walk_2D.avi` in chapter005 of the CD-ROM.

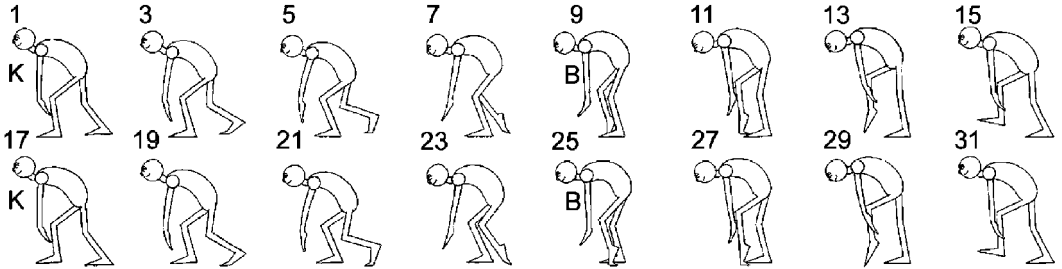

A not so clever person will move in a similar way, but this time the reason why the person finds movement such an effort is that they find walking intellectually difficult! If this dragging of the feet with droopy shoulder movement is topped with an erect head with a stupid grin and half-open eyes (too much effort to open the eyes fully), your character has a goofy look. Have a look at `not_so_clever_walk_2D.avi` in chapter005 of the CD-ROM.

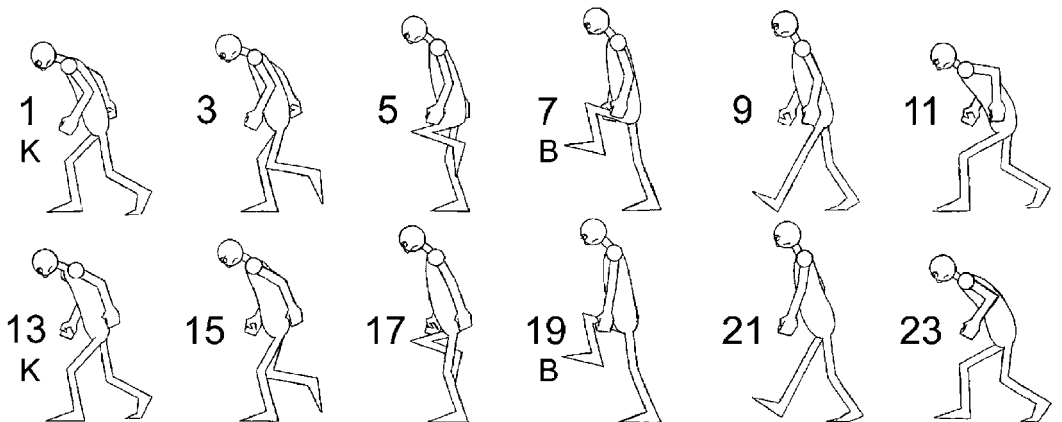
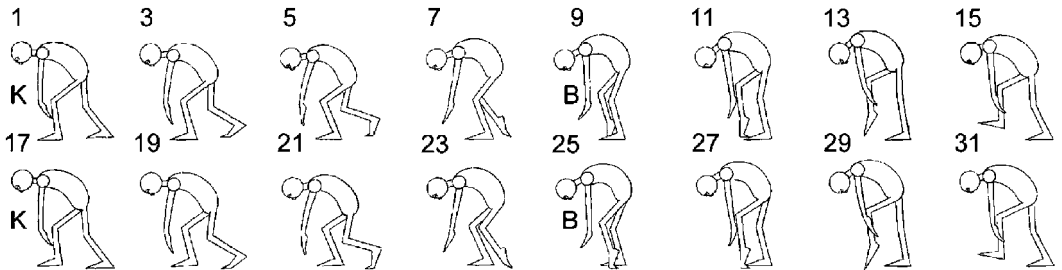

An angry person has something they are angry at, focusing their attention/gaze on the object of their anger. They will stamp their feet and clench their fists, holding their body at a stiff angle forward, maybe fixing their gaze toward the thing they are angry at. Shoulders rolling over the top as they move forward. Have a look at angry\_walk\_2D.avi in chapter-005 of the CD-ROM.

A determined person will move in a similar, smaller way but with the emphasis on the body angle. Everything about this person is pointing toward the goal that they want to achieve. Head down like a bull that is about to charge, keeping the leg and arm movements small so that nothing gets in their way.

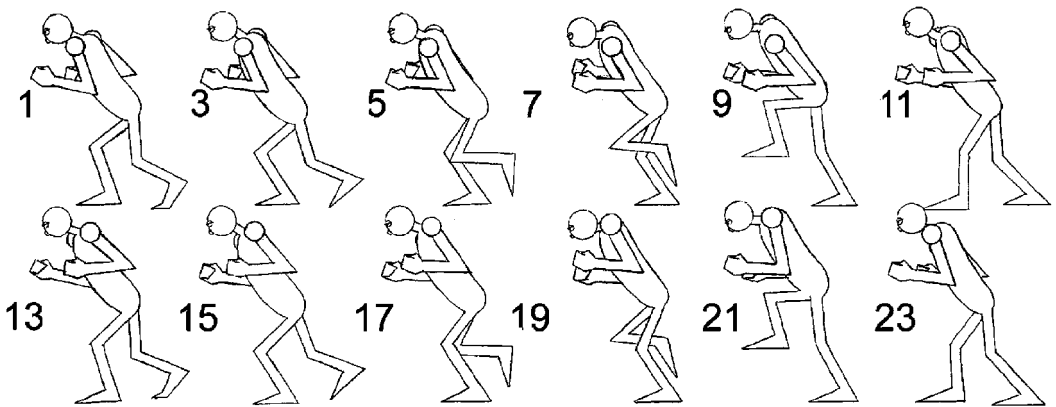

A happy person will walk with a spring in their step, perhaps putting a double bounce into their stride at the point where all the weight is on one foot. The strides will be light and the arms will swing with a snap (much slower at the extremes). It's as if they are full of energy and they are putting the excess into their walk. Shoulders rolling underneath as they move forward. Have a look at happy\_walk\_2D.avi in chapter005 of the CD-ROM.

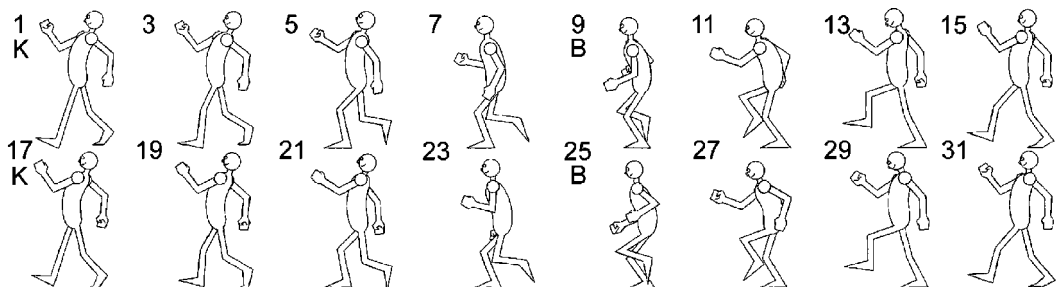

If somebody wants to be quiet when walking they could tip toe. This involves taking little steps on the tips of the toes. See `tip_toe_2D.avi` in chapter005 of the CD-ROM.

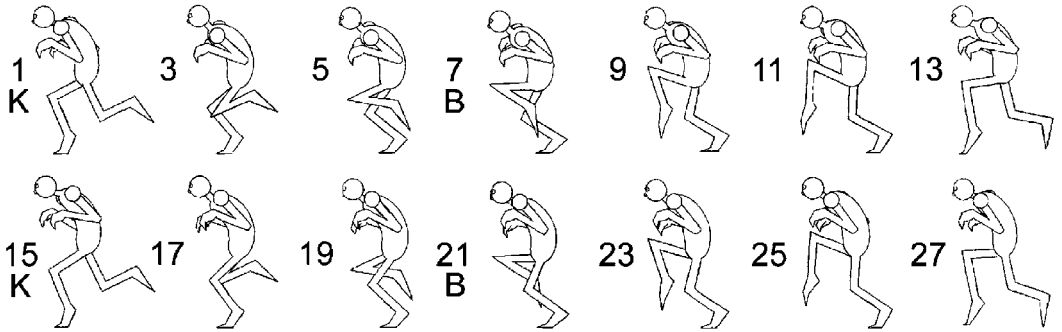

If someone wants to be really quiet (or is walking over a pond of ice and testing the surface) they could sneak. This involves placing the feet slowly onto the ground to test the surface (to see if it will make a noise or break). When the character knows the surface is OK, they will move forward and take the next step. See `sneak_2D.avi` in chapter005 of the CD-ROM.

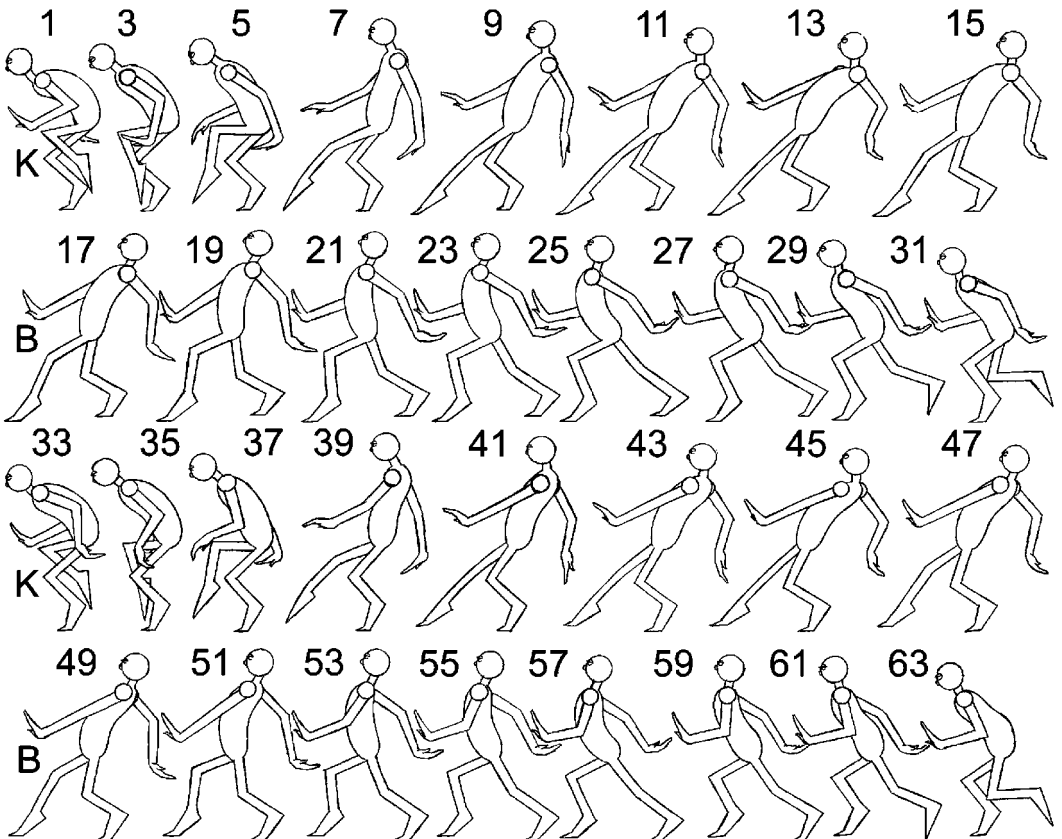

If somebody is cool and laid back, they are going to adopt a laid back position when they walk. The whole point of this type of walk is to give the impression that as little effort as possible is being put into it. The body is angled back and the legs are bent to help with balance. As the legs are picked up the body will slowly lower and then rise as the legs are kicked forward. See `cool_walk_2D.avi` in chapter005 of the CD-ROM.

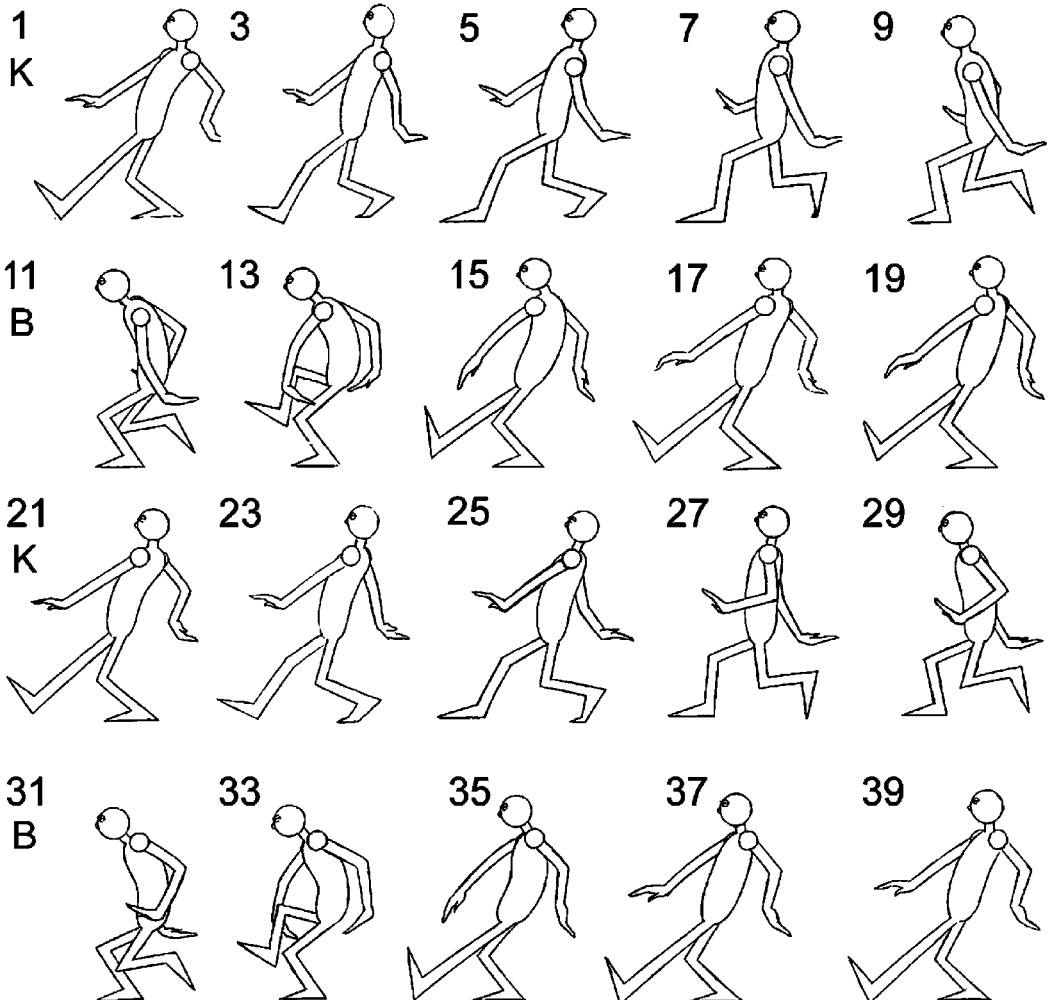

A dreamy person will float along, giving the impression of being very light. It's as if they are being carried along by their thoughts. The movement being like a leaf falling off a tree. Make them cushion themselves with their extended toe at the start of each stride. See `dreamy_walk_2D.avi` in chapter005 of the CD-ROM.

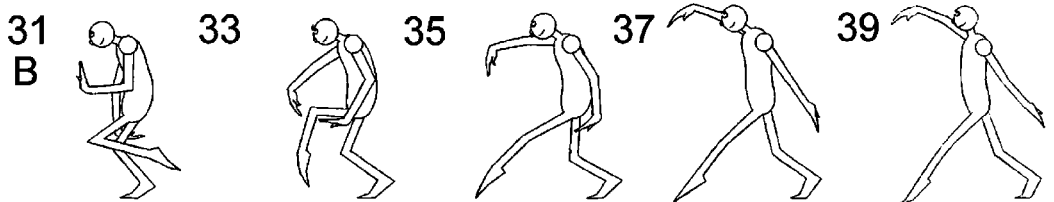
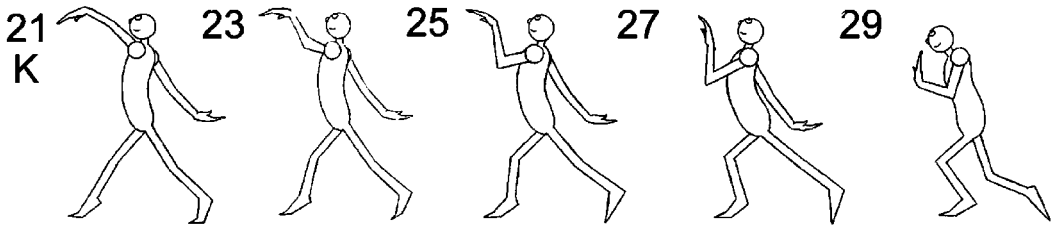
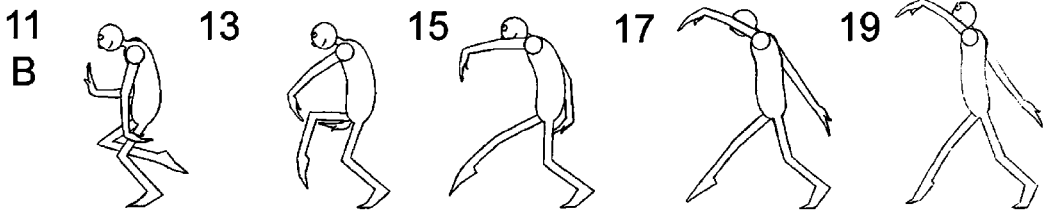
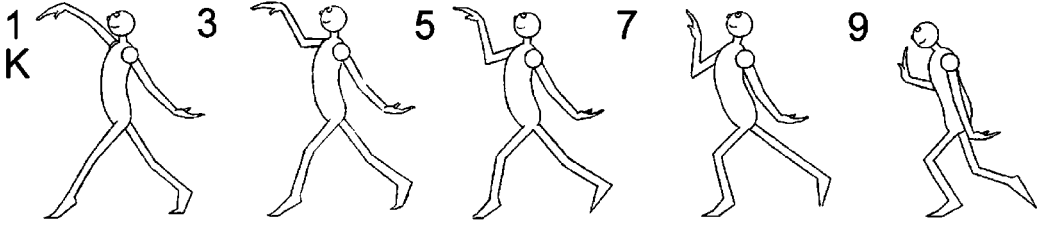

The double bounce walk is a type of walk used by a lot of cartoon characters. It involves having a dip of the body at the point where the front foot contacts the ground and a second dip of the body as the rear foot leaves the ground. See `double_bounce_walk_2D.avi` in chapter005 of the CD-ROM.

A walk can emphasize the sexuality of the walker. With a male this will involve a laid back top part of the body combined with a pelvic thrust at the lower part of the body with every stride. See `macho_walk_2D.avi` in chapter005 of the CD-ROM.

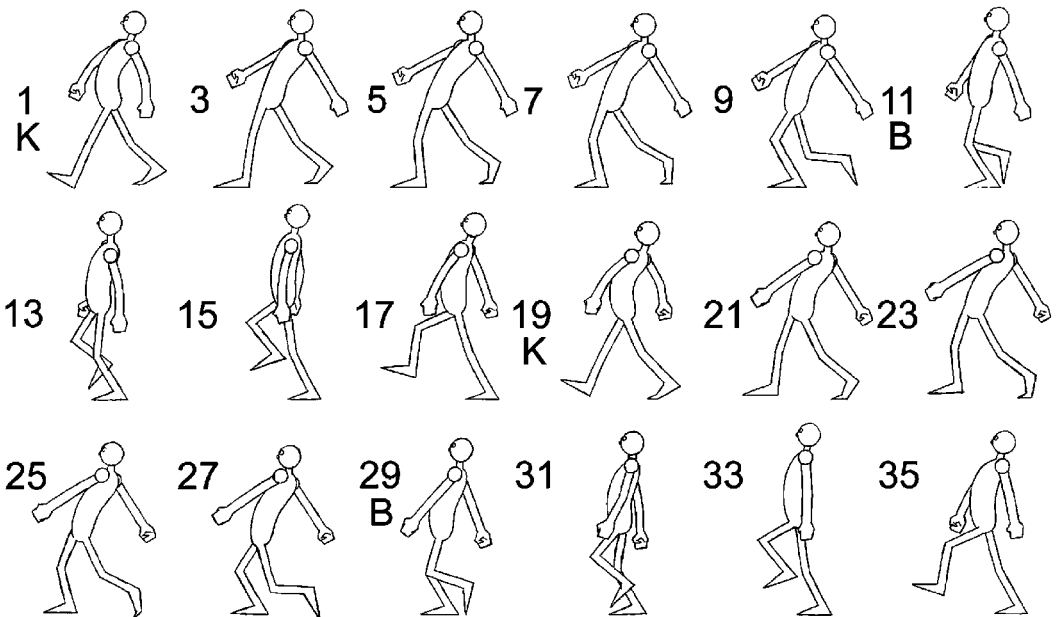
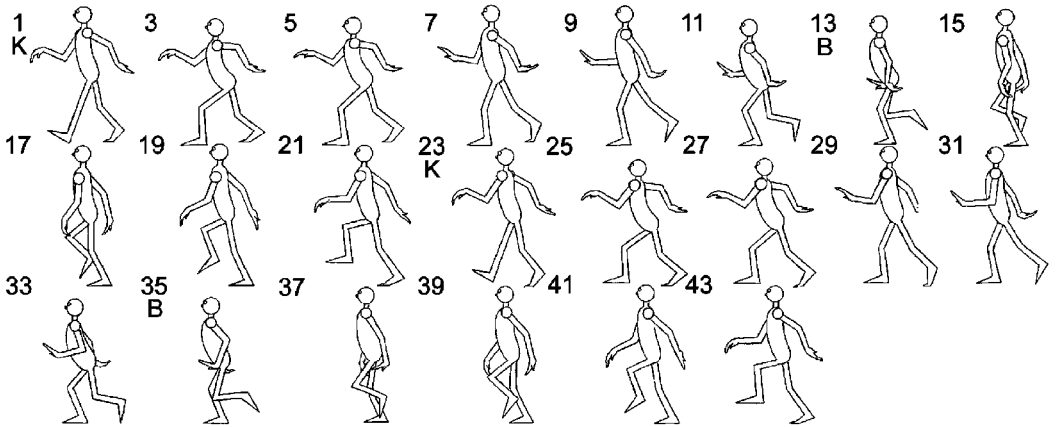

A female catwalk model's walk involves pushing out the hips sideways at each stride position. The small of the back is very curved and this pushes out the breasts and the bottom. The walk is on tiptoe (or high-heeled shoes). Because of this, during a walk it is difficult to bend the knee while all the weight of the body is moved over the leading leg. This results in the leg locking straight and the hip being pushed out to take this weight. The feet being placed in a central line in front of each other accentuate this. See `model_walk_2D.avi` in chapter005 of the CD-ROM.



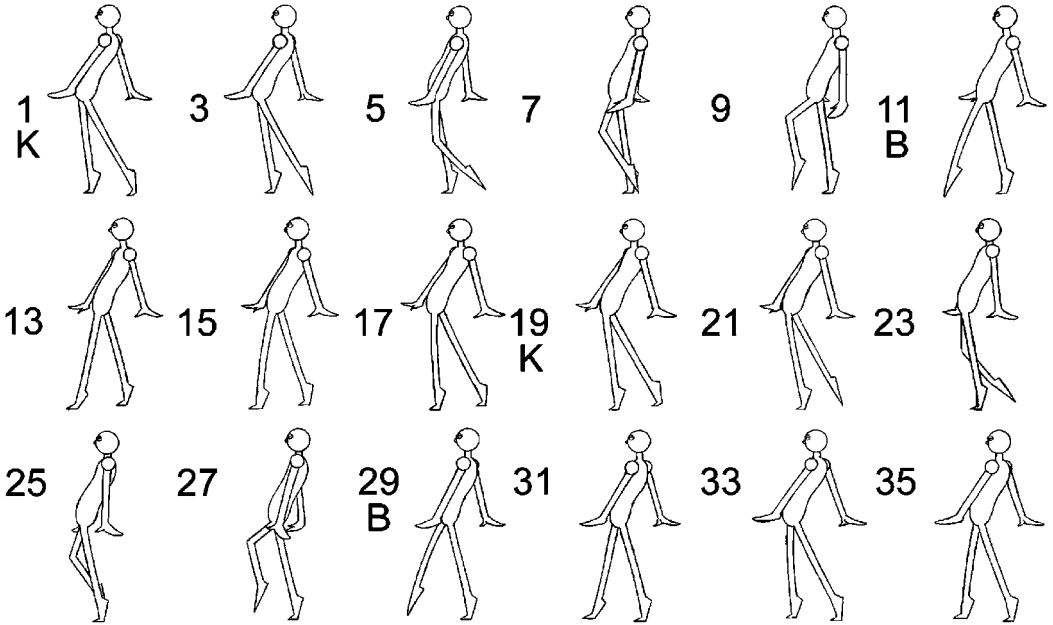

## external influences

When somebody is walking along not only will they have these internal influences; they have to contend with external ones too. Is the person carrying or pulling something? If so they will be straining to hold, pull or carry the object they are interacting with.

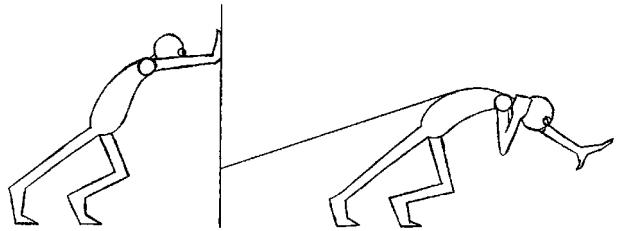

Are they walking up or down something (a ramp, a hill, stairs, etc.). What's the temperature (somebody who's hot will seem exhausted) or is the wind blowing (they have to push against the wind). Is the surface they are walking over smooth or rough? Somebody picking their way over a rocky landscape will be watching their feet, making sure they don't trip up).

Do they have to step over something (again they will have to look down in order to see where their feet are stepping) or is their attention taken by something that they are looking at (for example, a poster or cars, when they are crossing the road). Are they eating chips or talking on a phone.

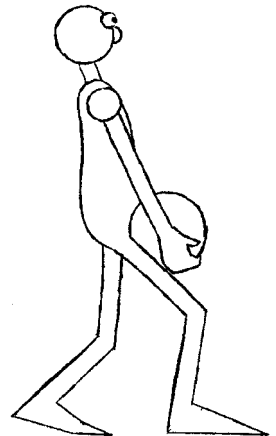

## two people walking together

When two people interact they do something called 'mirroring'. If you watch two people sitting in a pub together, they will often sit in a similar position to each other. They will take drags from a cigarette or sips from a drink at roughly the same times. Also scratch their heads or fold their arms in approximate unison. The amount of mirroring will vary depending on how well people know each other. Those who are good friends mirror more. Married couples who are used to each other's company (perhaps they are even bored with each other) tend to mirror less, depending on how much they want to emphasize their personality, but will return to mirroring at certain points during their interaction. The same can be said of two people walking together. They will often speed up or slow down their walk (or shorten or lengthen their strides) so they take steps at roughly the same time, especially if they are talking together. If their attention is taken by something else (a poster for example) they will revert to their natural walking pace (as they look at the poster), regaining their unison walk when they have each other's attention.

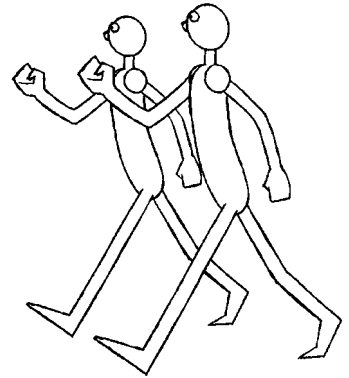

## running

The main point of a human running is to get from A to B as fast as possible. This is achieved, not by making the strides quicker (this results in a fast walk) but by making the strides longer. Each stride is basically a jump, with both feet off the ground. Each cross over point is the squash down following the jump, combined with the anticipation for the next jump. The twists in the body will be an exaggerated version of a walk cycle. The line of balance is pushed forward as if our character is falling forward – this gives more momentum.

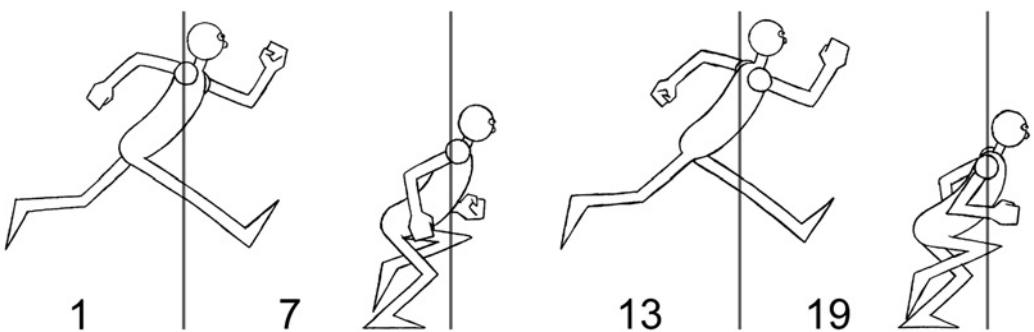

There are four basic key drawings to a run cycle:

1. Near side leg leading a stride and the far side leg trailing.
2. Near side leg impacting the ground and bending as the far side leg crosses over.
3. Far side leg leading the stride, near side trailing.
4. Far side leg impacting ground and bending as the near side leg crosses over and so on.

When in-betweening these key positions remember to bring the foot up and over from the stride position to the cross over position. Have a look at `run_2D.avi` and `run_3D.avi` in chapter005 of the CD-ROM.

Of course, because the stride is a jump, the squash is much bigger than during a walk cycle. The difficult bit is putting some character into your run.

If your character is running away from something it's as if the legs are running away with them. The legs could drag the body. See `run_away_2D.avi` in chapter005 of the CD-ROM.

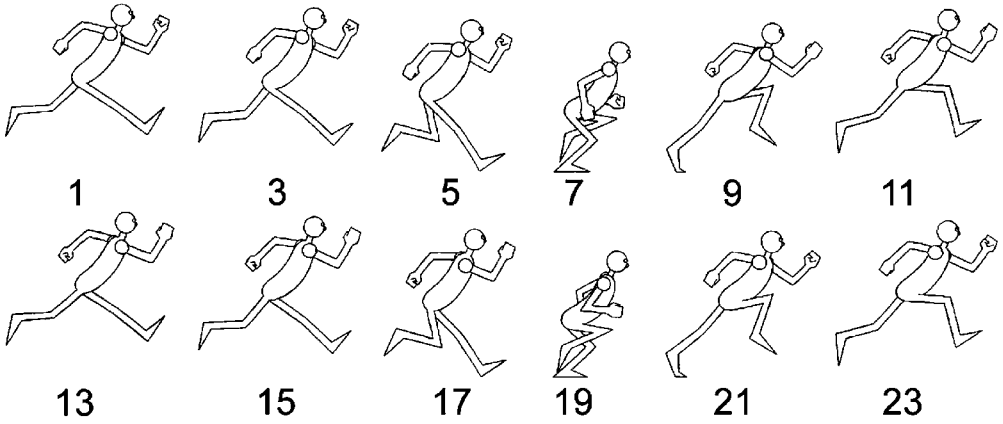

If somebody is running towards something, they will lean towards what they are chasing (be it something that is moving or the finishing line). See `run_toward_2D.avi` in chapter005 of the CD-ROM.

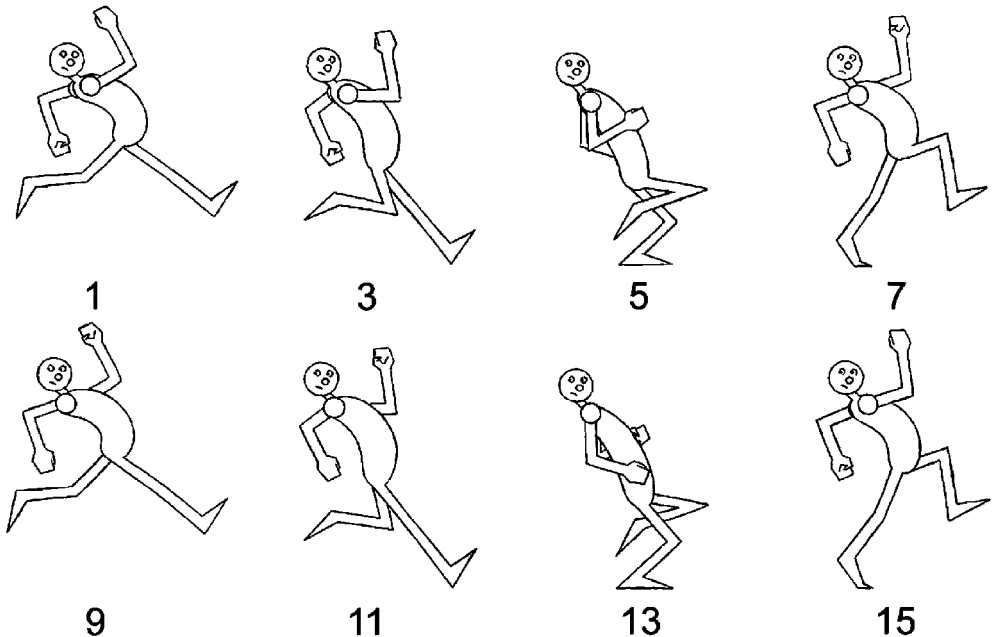

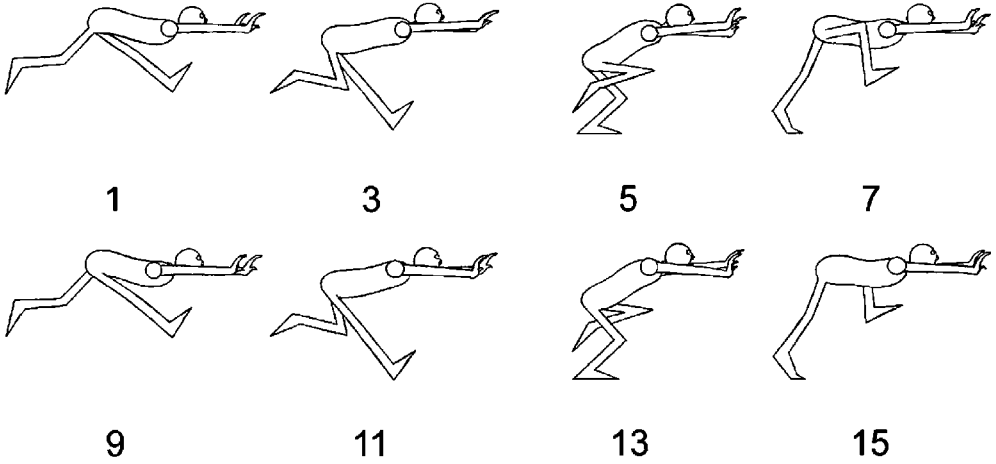

One good way of helping a run cycle work is to add whiz lines or to smear the arms and legs and if it's on singles also offset the legs slightly so that the legs don't strobe. See `fast_run_2D.avi` in chapter005 of the CD-ROM.

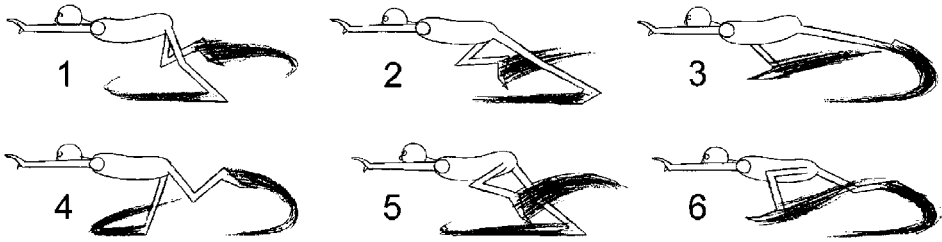

A skip is a kind of run that involves a floating stride position and landing on the rear foot. See `skip_2D.avi` in chapter005 of the CD-ROM.

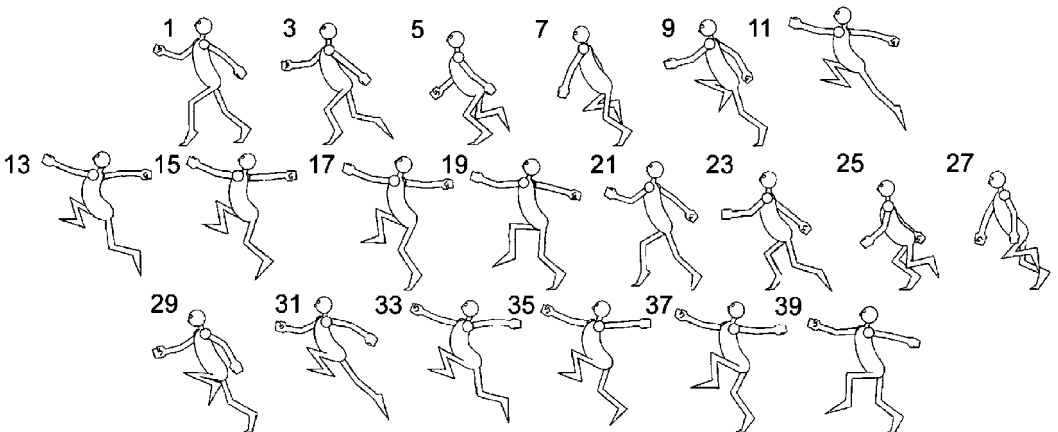

Take a look at `humanlocomotion.pdf` on the CD-ROM for larger versions of these illustrations.

## exercises

### walk or run cycle in 2D

Take any of the illustrated examples of walk cycles or run cycles and have a go at a character walking or running on the spot.

In order to do this you have to think of your character walking on a treadmill (the kind of device that you get in a gym).

Think of the body staying in the same position on the piece of paper, it can go up and down but not backwards and forwards.

Start with the two stride positions. They are basically mirror images of each other. Make sure that you take into account perspective when you draw each of these. This will prevent the character from 'strobing' (this is when the stride positions you've drawn look so similar that your audience can't tell the difference between them when the sequence is played).

Take a look at any of the ... walk\_2D.avi's in chapter005 of the CD-ROM.

Have a go at animating several of the different walk cycles.

### walk or run cycle in 3D

Because there is nothing new to learn in each of the 3D computer programs covered in this book I will only give a very general guide as to how to animate a walk cycle in 3D rather than doing each of the specific programs.

Take out your animation drawings for the walk or run cycle (or refer to the relevant illustrations).

We are only going to animate two strides (one complete cycle) and then loop the animation on playback. Our character will be walking on the spot, sliding its feet backwards along the ground and then picking them up to cross over and bring them forward.

In order for this to work correctly we need to set the length of the scene to one frame longer than the drawn walk or run cycle. For example if we are animating the basic\_walk, which is 24 frames long we need to set the length of the animation on your chosen computer program to 25 frames (this is fine for XSI and Maya; in LightWave and 3DS Max the first frame of a scene is 0 (zero) so set the scene length to 24).

Load your character model and move it into the first key position at the first frame of your animation. This will be a stride. Set a key for this position. Go to

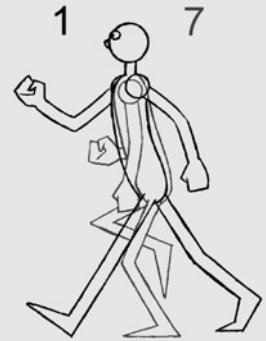

Frame 1.



the last frame and, without moving anything, select your model (or the individual sections that you moved at the first frame) and set a key.

Move the time/frame slider to the frame of the next stride key position and move your character into the position of this stride, setting keys as you do so. For example in the basic\_walk this will be at frame 13.

When you play the animation it will give the impression of the character sliding its feet backwards and forwards on the floor.

At each of the frames where the cross over breakdown positions occur move your character into a cross over position and set a key. For example in the basic\_walk these will be at frames 7 and 19 (6 and 18 in LightWave and 3DS Max).

Add extra key positions or manipulate the animation/function curves in order to stop the feet sinking and sliding in the wrong places.

If you want to add whiz lines make a sphere, distort it so it looks roughly like the shape of your drawn whiz line and place it behind one of the legs. Change the shape of the distortion for each frame, matching your drawn animation and render it as semi-transparent. Do the same for the other leg.

When it comes to rendering your animation, don't render the last frame. For example in the basic\_walk the piece of animation you have been animating is 25 frames long but only render 24 frames. This will prevent a pause at the point where the animation loops.

### *changing the pace and mood in a walk in 2D*

The background for the exercise we are going to do is like this one on the right.



Frame 13.

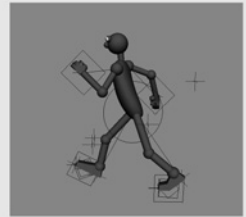

Frame 7.

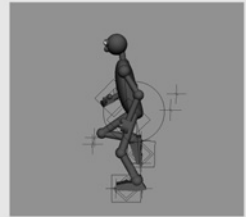

Frame 19.

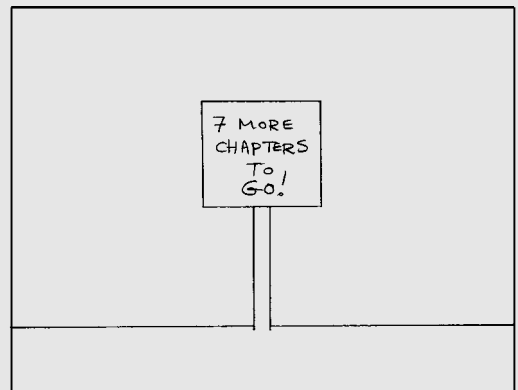

The idea is to have a character that walks into the scene from screen right, slows down to look at the sign (by taking shorter strides) and then, as a result of reading the sign, walks out screen left displaying a different emotion.

Our character will be walking along the floor this time, rather than sliding the legs back as in the walk cycle exercise.

The illustration shows the key positions for a character walking into the scene happy, slowing to see the sign and walking out unhappy as a result of seeing what is written on the sign.



First work out the stride positions all the way through the scene. Once these are done and you are happy with the pace put in the breakdowns. These are the cross over positions.

Take a look at `walk_by_2D.avi` chapter005 of the CD-ROM.

You don't have to follow this scenario. You may want to have a sad person become happy, or a miserable person become dreamy or a stupid person acquiring some intelligence, just make sure your audience understands it.

## *changing the pace and mood in a walk in 3D*

Start by building a floor for the character to walk on. Make it out of a grid, plane, box or cube. It should be about 100 units wide (1000 units for 3DS Max) and 30 units deep (300 in 3DS Max).

Don't make it any taller than 1 unit. Position it so that the majority of its length is in front of our character.

Make a sign for our character to read by creating a post out of a box or cube and make it 15 units high (150 in 3DS Max) and one unit wide and deep (10 units in 3DS Max). Position it 30 units in front of our character and 15 units to the side. Make the notice board attach to the post

by creating a box or cube 10 units tall and wide (100 units in 3DS Max) and 1 unit deep (10 units in 3DS Max), and position it at the top of the post.

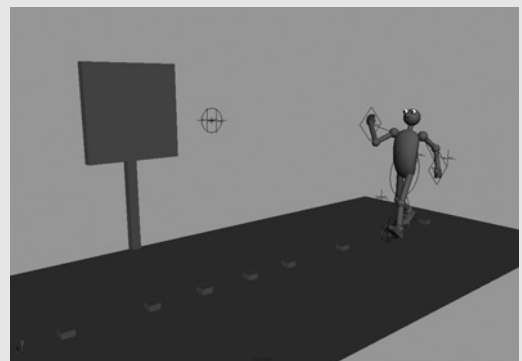

Using your animation drawings (or copy the first illustration in the walk and run cycle in 3D exercise), work out the basic stride key positions of the entire sequence.

This time the character will be walking along, rather than having the feet slide back, like during the walk cycle exercise.

One thing that can help is to put a block/cube/box at each of the points where the heel of the character touches the ground. This can act as a permanent marker for where the character is going to put his heel at each stride. Each stride during the happy part of the walk is 8 units long so place the blocks 8 units apart. At the point where the character is looking at the sign the strides are about 5 units apart so place the blocks 5 units apart. During the depressed walk part of the scene the strides are about 7 units apart so put the blocks 7 units apart. When your animation is done just delete the blocks!

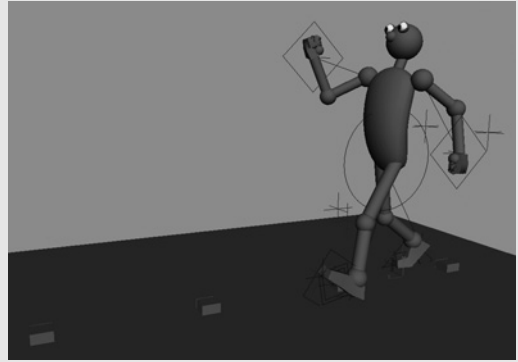

Once the key positions are done, go back and sort out the cross over breakdown positions.

To stop the feet slipping and sinking into the ground make sure that the rotation and translation animation curves that relate to the foot controls are flat at the points where the feet touch the ground.

Tweak your animation as needed and hopefully you will end up with something like walk\_by\_3D.avi in chapter005 of the CD-ROM.



## chapter 6

# animal walks and runs

### chapter summary

- *the four types of animal locomotion*
- *construction of an animal*
  - pantomime horse*
  - cartoon four-legged walks*
  - correct four-legged animal construction*
- *animal leg and foot construction*
- *animals with paws*
- *a dog walk*
- *a cat walk*
- *animals with cloven feet*
- *animals with hooves*
- *flat feet*
- *animal runs*
  - trotting*
  - cantering*
  - galloping*
  - transverse or rotary gallops and canters*
- *exercises*
  - dog walk cycle in 2D*
  - dog walk cycle in 3D*
  - dog walk or run cycle in 3D*

## the four types of animal locomotion

There are four kinds of gaits (types of locomotion) adopted by animals. These are walking, trotting, cantering and galloping. Before covering these we have to understand how different styles of animals used in animation are put together.

### construction of an animal

The best way to get an idea of how a four-legged animal moves is to go out and sketch some. Go to a zoo or a farm or just to the local park and draw animals. Don't worry if your drawings don't seem that good. The whole point of sketching is to make you look at your subject for long periods of time and to assimilate how they are constructed and how they move.

There are three ways to construct a four-legged animal. These are pantomime horse, cartoon four legged and correct four legged.

#### *pantomime horse*

This involves constructing your four-legged animal like two actors in a horse suit.

When the two actors walk in unison they will probably do something like that shown in the illustration. Both pairs of legs doing a basic human walk!

The walk consists of the four major key positions. The first key position is at frame 1: Stride at the front, cross over at the back. The second key position is at frame 7: Stride at the back, cross over at the front. The third key position is at frame 13: Stride at the front, cross over at the back (mirror image of the first key position). The fourth key position is at frame 19: Stride at the back, cross over at the front (mirror image of the second key position). This means that there is always at least two legs touching the ground and, in

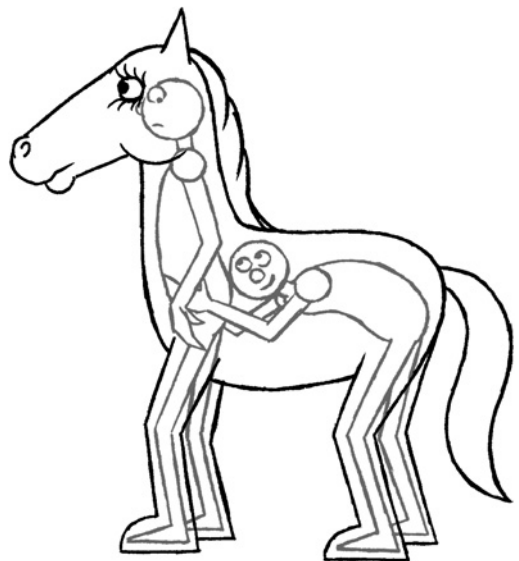
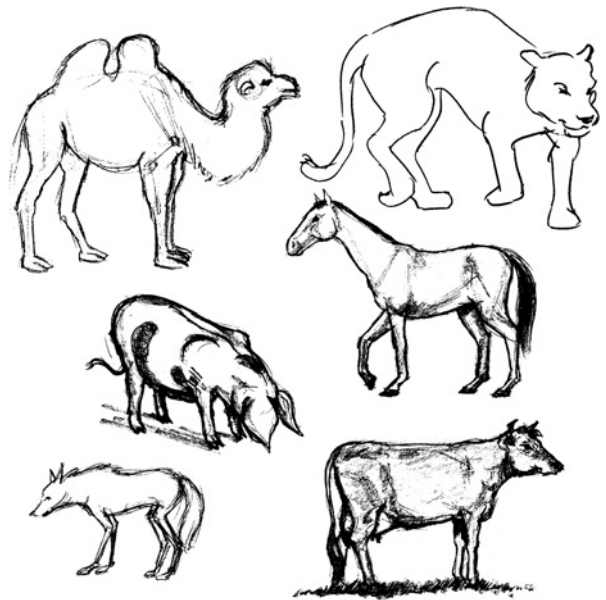

order to maintain a 'tripod' of balance, three legs will remain on the ground for as long as possible.

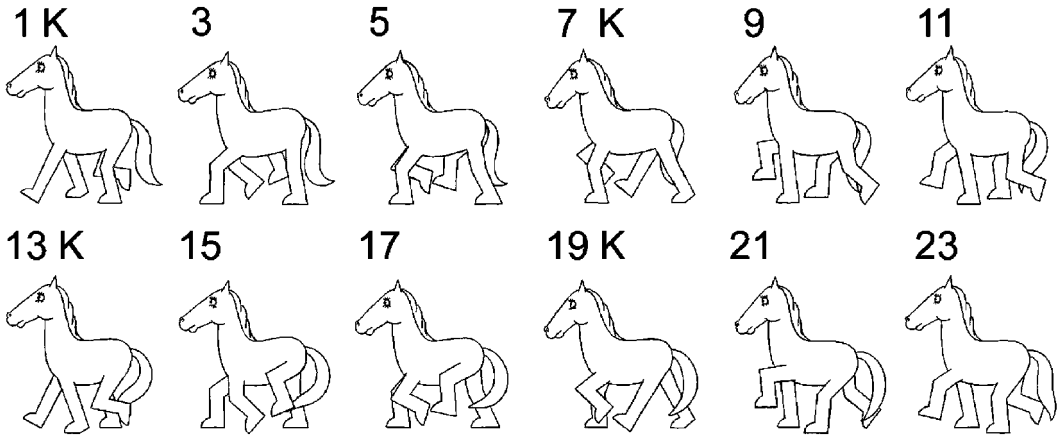

The stride at the back is the same length as the stride at the front and the foot of the leading leg at the rear will step into the footprint of the trailing leg at the front.

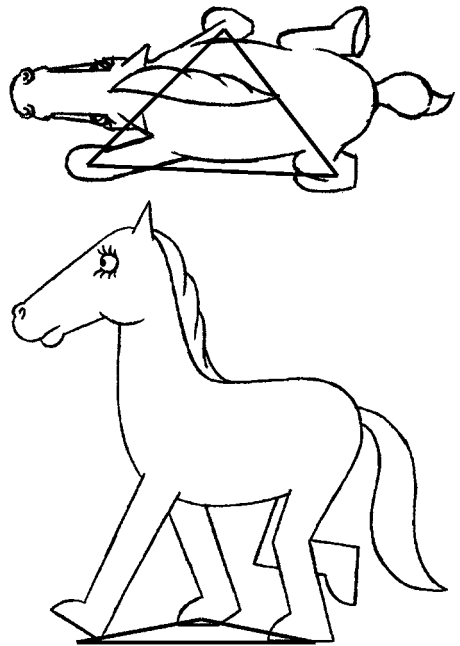
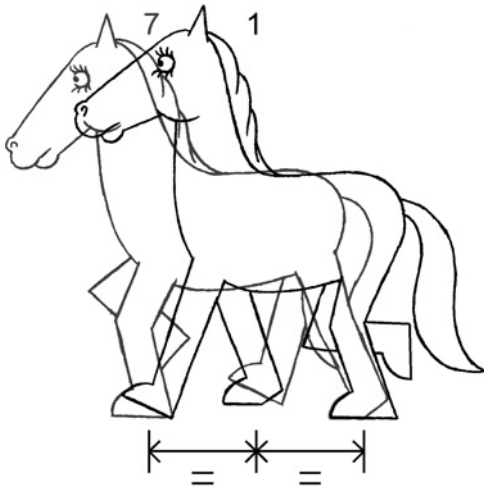

This is a very unrealistic walk for a four-legged character to do. The construction is entirely wrong, but it can be quite effective. It tends to look better when you are animating a toy-like character. Bullseye in *Toy Story 2* walks like this.

I've included a basic panto\_horse.avi in chapter006 of the CD-ROM.

## cartoon four-legged walks

For this type of character think of a human on all fours.

The rear legs of our character are like the legs of a human. The front legs of our character are like the arms of a human.

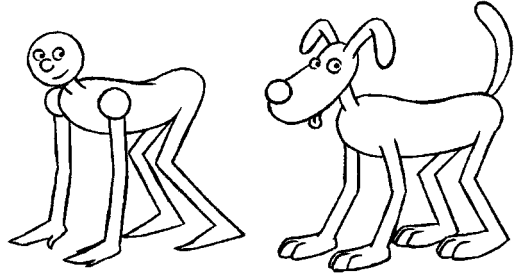

This is much closer to the way that a four-legged character is realistically constructed but is still a simplified cartoon version.

The way to animate a walk with this character is to do something similar to the walk made by our two actors in a pantomime horse but to make sure that the legs bend in the correct way. The stride of the back leg will be the same length as that of the front leg. The legs will still maintain the tripod of balance.

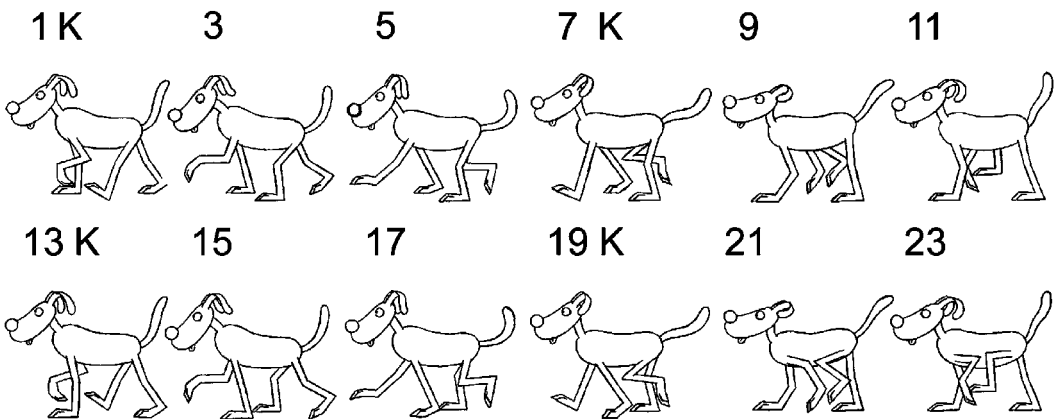

The first key position is at frame 1: Stride at the back, cross over at the front. The second key position is at frame 7: Stride at the front, cross over at the back. The third key position is at frame 13: Stride at the back, cross over at the front (mirror image of the first key position). The fourth key position is at frame 19: Stride at the front, cross over at the back (mirror image of the second key position). Also, as the back leg at positions 3 and 5 comes down to touch the ground the rear leg at the back of the stride will be picked up. Again this leaves the three legs in contact with the ground for as long as possible.



As with the pantomime horse walk, the tripod of balance will be maintained for as long as possible and the foot of the rear leading leg will step into the front trailing leg's foot print.

This kind of walk and construction is suited to the types of animal character that jump up and become more human-like. Characters that talk and gesticulate with their front legs. Examples are Tom and Jerry and Bugs Bunny.



I've included a basic cartoon\_dog\_2D.avi in chapter006 of the CD-ROM.

### *correct four-legged animal construction*

This is a four-legged animal that is constructed like a real quadruped.

Still think of your animal as a human on all fours, but rather than standing with the feet and the hands flat on the ground, the feet are articulated differently depending on the animal. The rib cage on the animal is elongated downwards whereas a human rib cage is flat. The shoulder blades on an animal are on the side of the rib cage. On a human they are on the back.

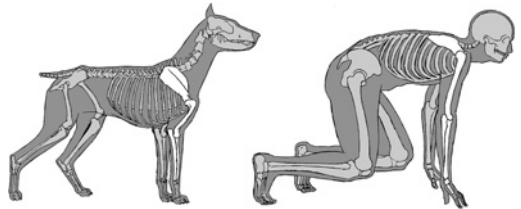

These animals do not have a collarbone like a human. This allows the shoulder blade to rotate and move up and down more freely. It's as though the shoulder blade of a four-legged animal has a sliding pivot point that can move up and down the side of their rib cage. When all the weight is on one of the front legs the body will drop in relation to the shoulder, making the top of the shoulder blade stick out at the top of the body.

## **animal leg and foot construction**

The construction of the legs and feet of a four-legged animal influence the way in which they walk.

### **animals with paws**

At a stretch, this category could include cats (big cats as well as domestic cats), dogs (all breeds as well as wolves and wild dogs), rodents (although they vary enormously) and some marsupials.

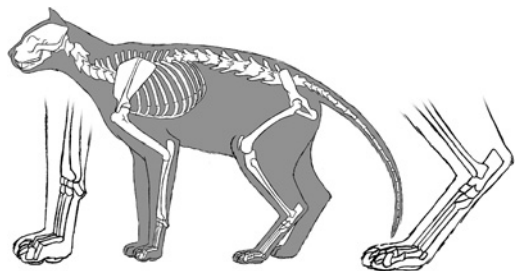

Notice how the length of all four feet has been elongated and how the animal balances on the last two digits of the toes. The animal walks on pads. This gives the animal lightness as it walks on the ground. The legs remain fairly straight. Bend the legs when you want to suggest an animal is crouching in order to jump or sneak along.

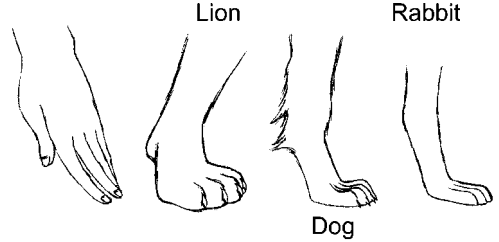

The rear leg is similar to the leg of a human, but again the feet and toes are elongated. The rear leg will always have a shape like a straightened S. A dog leg shape!

Whatever position it's in the foot and the thigh will stay in parallel with each other (with the exception of frames 9 and 21 where the foot drags).

When animating a basic, naturalistic animal walk it's a good idea to think of the same sort of tripod walk that we did with our pantomime horse and our human on all fours.

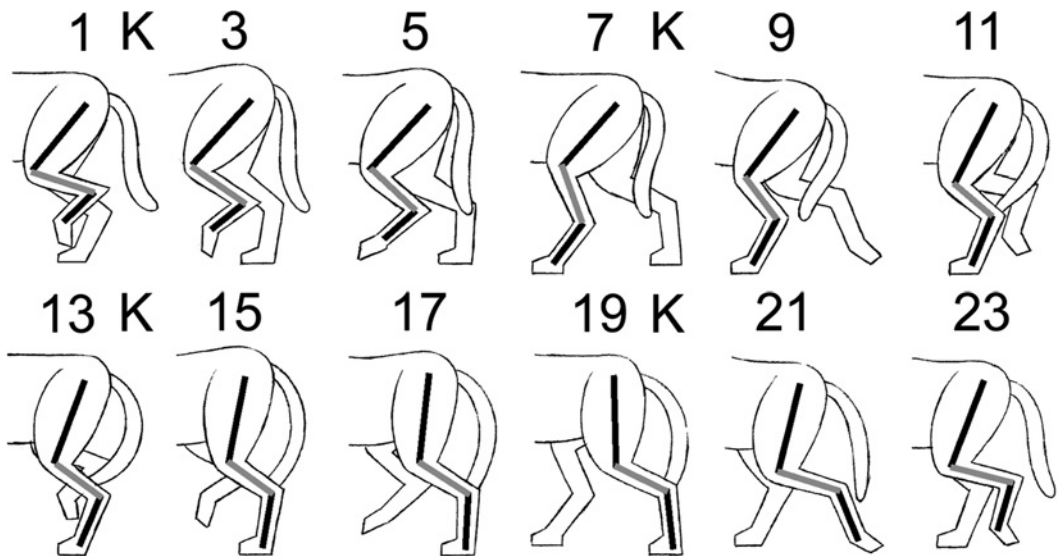

### a dog walk

A dog has a very solid, eager walk that displays a lot of weight. Have a look at dog\_walk.avi in movies006, chapter006 of the CD-ROM.

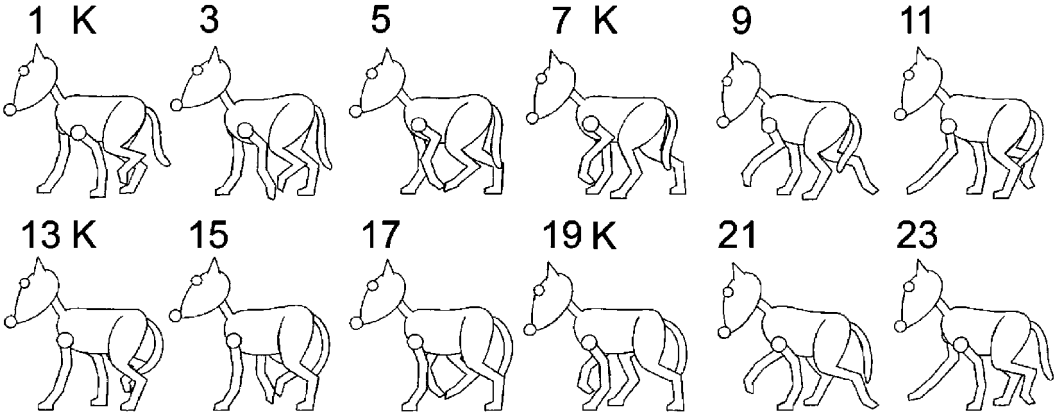

The backbone of the dog will be level at the stride and cross over key positions (frames 1, 7, 13 and 19). Between frames 1 and 7, as the dog moves forward the front part of the body will dip down as the weight goes onto the forward leg of the stride. The back part of the body will rise to accommodate the rear leg being brought up and over, out of the cross over position. From frames 7 and 13 the rear part of the body will dip down as the weight goes onto the leading leg of the stride and the front part of the body will rise to accommodate the front leg being brought up and over. Between frames 13 and 19 the back does the same thing as between frames 1 and 7 and between frames 19 and 1 the back does the same thing as between frames 7 and 13 (the illustration shows the first half of the cycle and in the remaining part of the cycle the back will do the same thing; 13 is the same as 1, 15 is the same as 3, 17 is the same as 5, etc.).

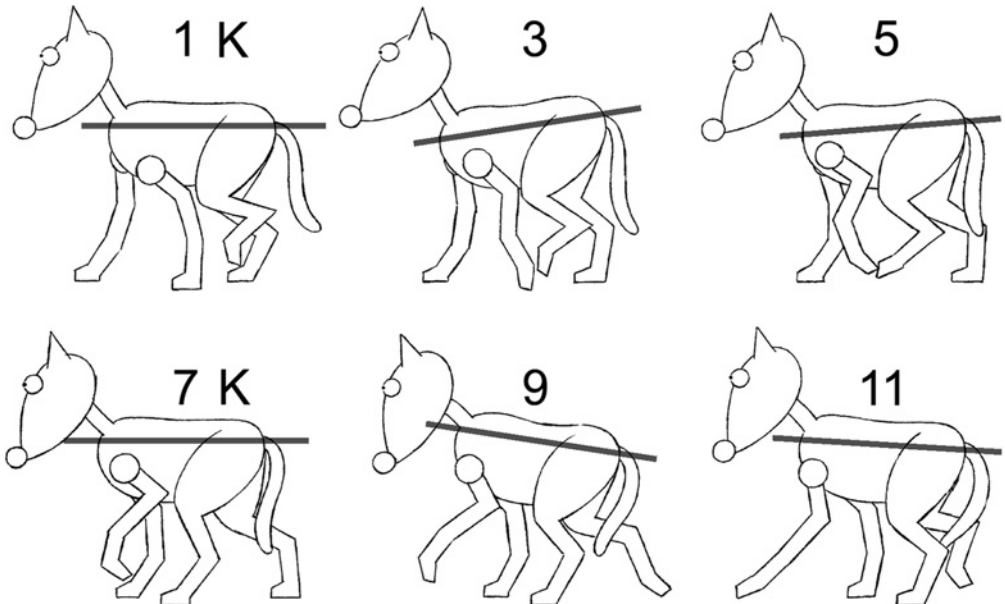

The other thing to take into consideration (especially if animating a rear or three-quarter view) is the twisting of the hips and the shoulders as the animal moves forward. (The illustration shows the first half of the cycle. In the remaining part of the cycle the hips will do the same thing, but as a mirror image. 13 is the mirror image of 1, 15 is the mirror image of 3, 17 is the mirror image of 5, etc.)

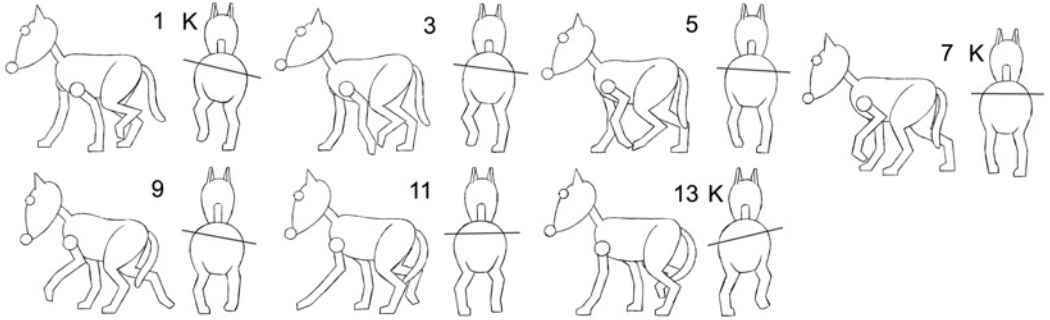

At the stride position, the hips are level. As the animal moves forward more weight is placed on the leading leg. Less weight is placed on the trailing leg and that side of the hip drops as a result. As the trailing leg is picked up and goes into the cross over position, the hip is raised to stop the leg dragging on the ground. Finally this leg reaches the next stride position and the hips are level.

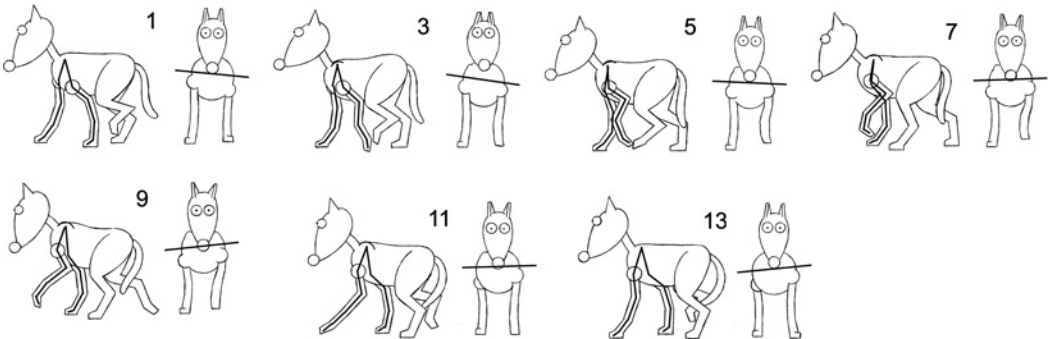

At the front most of the twisting is made by the movement of the shoulder blades, with only a small amount of rotation through the rib cage.

Generally at the stride position the shoulders and rib cage are slightly angled. The shoulder of the leading leg being slightly higher than the shoulder of the trailing leg. The leading leg's shoulder blade is facing forward, the trailing leg's shoulder blade is facing back. (The illustration above shows the first half of the cycle. In the remaining

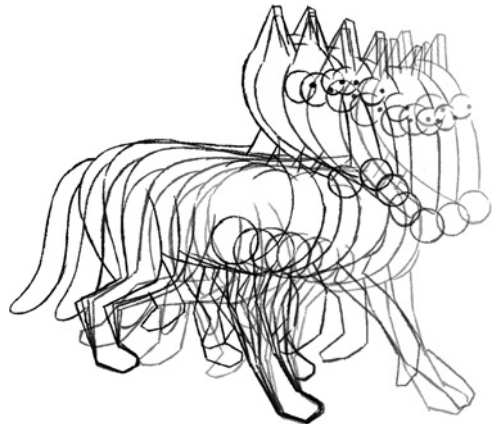



part of the cycle the shoulders will do the same thing, but as a mirror image. 13 is the mirror image of 1, 15 is the mirror image of 3, 17 is the mirror image of 5, etc.)

As the dog moves forward the rib cage will twist away and downwards from the leading leg and the shoulder blade of the trailing leg will drop. The shoulder blade of the leading leg (the leg in contact with the ground) will stick up through the top of the body as it takes all the weight. (The illustration shows the first half of the cycle).

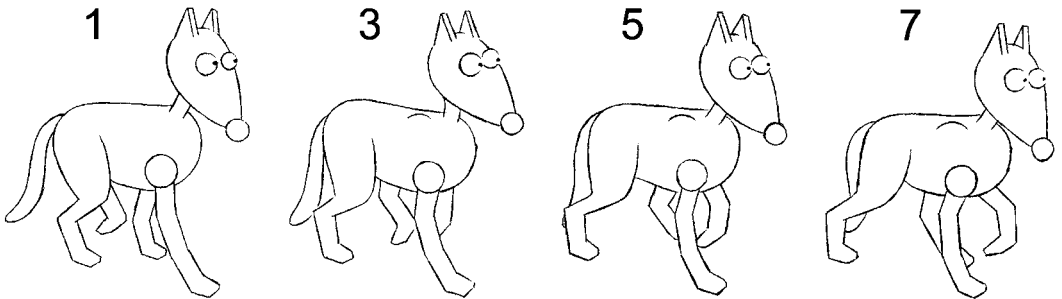

As the trailing leg moves to the cross over position, its shoulder blade will be higher than the shoulder blade of the leg in contact with the ground.

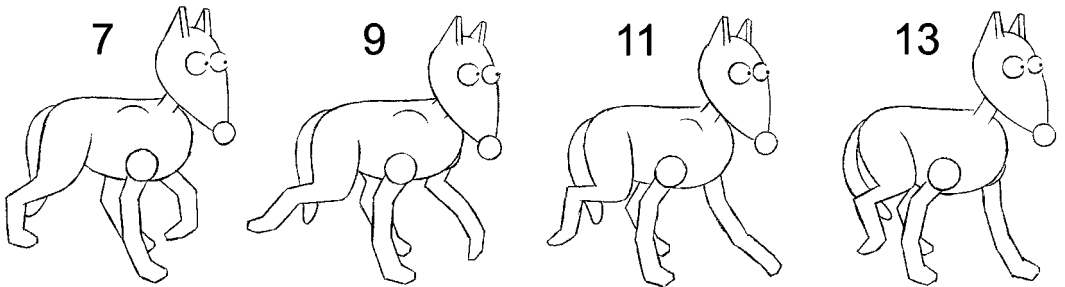

Finally we get back to the next stride position. The remaining drawings in the cycle will do the same thing but on the opposite sides. (The previous two illustrations show the first half of the cycle; the remainder of the cycle will do the same thing but as a mirror image. 13 is the mirror image of 1, 15 is the mirror image of 3, 17 is the mirror image of 5, etc.) From the top, the spine will twist from side-to-side in order to accommodate the stride positions.

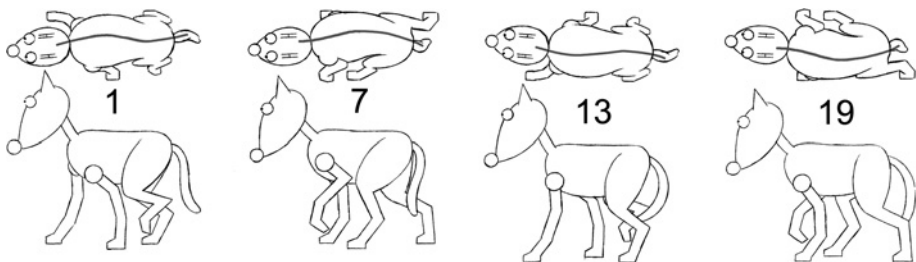

Take a look at `dog_walk_2D.avi` and `dog_walk_3D.avi` in `animations006`, `chapter006` of the CD-ROM.

## a cat walk

Where dogs are quite solid and resilient in the way they move, cats are rather floppy and nonchalant.

Have a look at `cat_walk.avi` in `movies006`, `chapter006` of the CD-ROM.

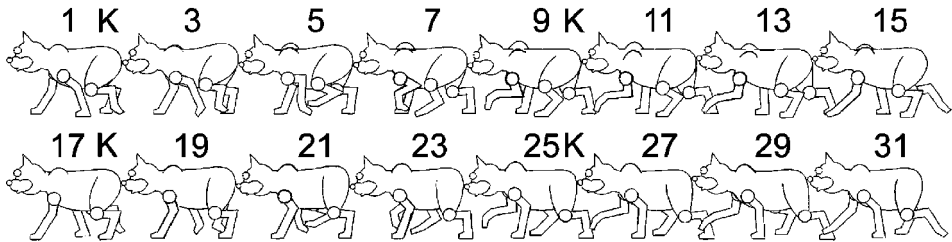

In comparison to a dog, cats tend to have longer back legs but the stride of both front and back legs will be of the same length. They are more likely to hold their bodies lower to the ground and tend to pick up their legs slightly slower than a dog will. A cat's hips will move in a similar way to the hips of a dog. The noticeable difference in movement is at the shoulders.

To give a cat that 'can't be bothered' feel to their walk the rib cage should always be suspended lower between the shoulder blades, than a dog's rib cage is. This makes the shoulder blade of the leg in contact with the ground stick up through the top of the body. The leg that is picked up to cross over will drop, leaving the shoulder blade lower than the outline of the body. The rib cage drops and twists slightly. (The illustration shows half of the cycle. Frame 17 is a mirror image of 1, 19 is a mirror image of 3, 21 is a mirror image of 5, etc.)

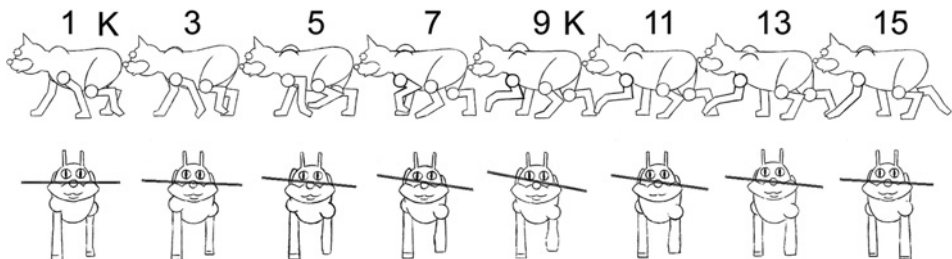

At the cross over position the rib cage remains dropped (although slightly raised, compared with the stride position) and the shoulder blade of the leg in contact with the ground remains visible through the top of the body.

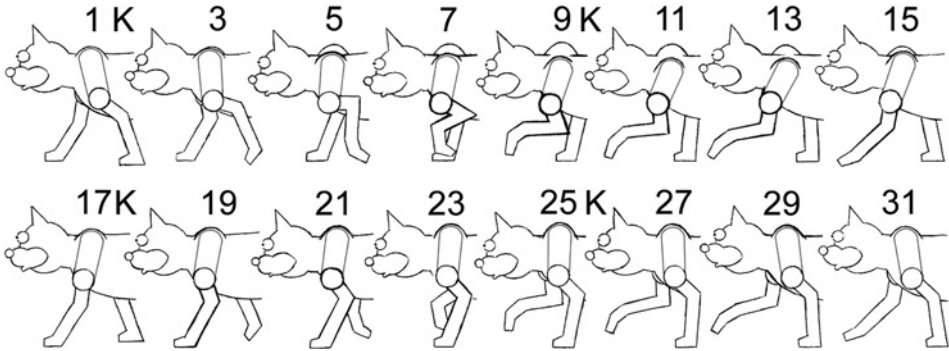

The raised leg then moves to the next stride position. The twisting of the spine (from the top view) will be similar to that of a dog.

Take a look at `cat_walk_2D.avi` and `cat_walk_3D.avi` in `animations006`, `chapter006` of the CD-ROM.

## animals with cloven feet

This covers animals such as cows, sheep, pigs, goats and deer and relates to the fact that these animals walk on the equivalent of two fingers.

These extended digits are referred to as the fetlock. The lengthening of these digits extends along the length of the leg, allowing for a longer stride, thus enabling these animals to walk and run faster.

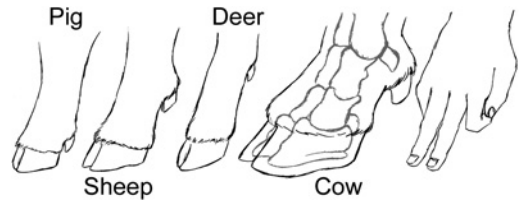

Take a look at `cow_walk_2D.avi` in `animations006`, `chapter 006` of the CD-ROM.

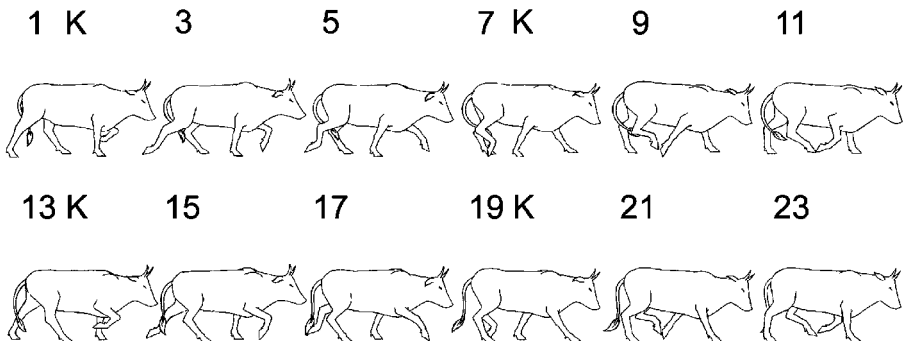

## animals with hooves

This covers animals such as horses, ponies, donkeys, zebra and giraffe. The fetlock of a hooved animal consists of a single elongated digit. If you imagine an extended finger, the bone at the end of the finger is the equivalent to the hoof.

Take a look at the live action horse\_walk.avi in movies006, chapter006 of the CD-ROM.

This elongation of the fetlock and the leg as a whole make these animals especially good at running.

The rules for the earlier four-legged walks also apply to a hooved walk. There will be a cross over at the back and a stride at the front and a tripod of balance will be maintained for as long as possible. There will always be at least two legs on the ground.

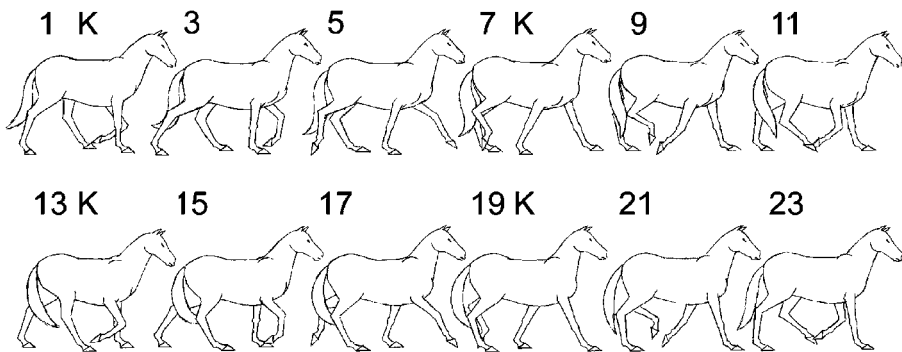
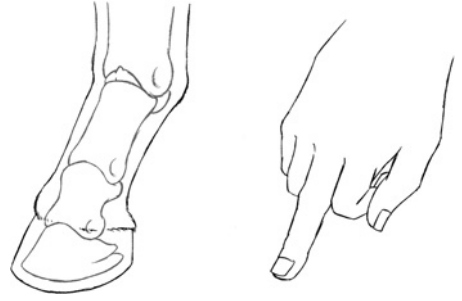

I've included a horse\_walk\_2D.avi in animations006, chapter006 of the CD-ROM.

The movement of the hips and the shoulders is similar to the earlier four-legged walks, but with an animal with hooves these movements tend to be more pronounced, because the legs are longer.

The head will counteract what the body is doing. The head will be down on the cross over position of the front legs and up on the stride. This head movement tends to be more pronounced on a hooved walk because the legs are much longer than on the other animal walks.

## flat feet

Animals such as elephants and rhinos walk on the equivalent of the bones at the very end of our fingers. Imagine the thumb facing backwards and three fingers facing forwards. These digits are very thick and heavy in order to take the large weight of the animal they are supporting. The remaining digits are very short.

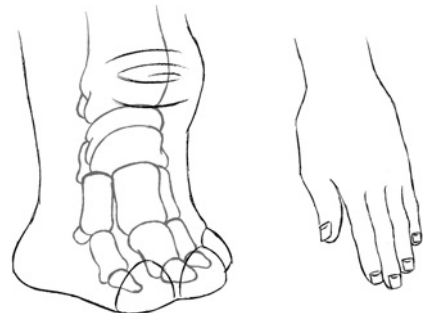

There is virtually no movement of these digits because they are firmly wrapped in flesh, which gives additional help to support the great weight of the animal they belong to. The solidity of the foot gives the appearance of it having one less joint than most animals.

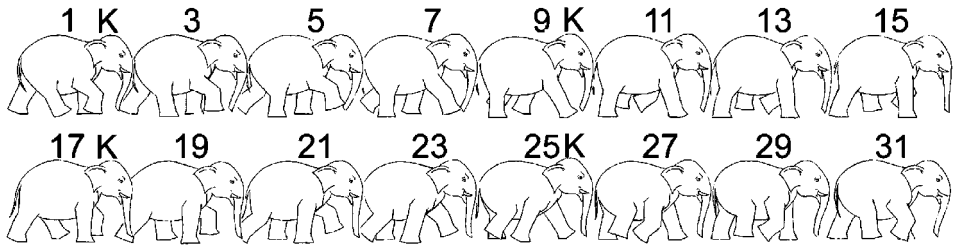

Take a look at `elephant_walk_2D.avi` in `animations006`, `chapter006` of the CD-ROM.

## animal runs

We've covered walking, now we need to look at the remaining three gaits: trotting, cantering and galloping. I've illustrated each of these gaits with a horse, but something very similar happens with most other four-legged animals.

In order to speed up, an animal, like a human, must lengthen its stride. To do this it needs to change its gait. That is, it must change the way in which it makes the strides.

### *trotting*

Have a look at `horse_trot.avi` in `movies006`, `chapter006` of the CD-ROM.

To move faster than a walk, the legs will move as diagonal pairs during a trot. This means that the animal is doing a stride at the back and a stride at the front at the same time and a cross over at the back and a cross over at the front at the same time. Add to this a little jump in the air during the stride position and your horse's stride is lengthened.

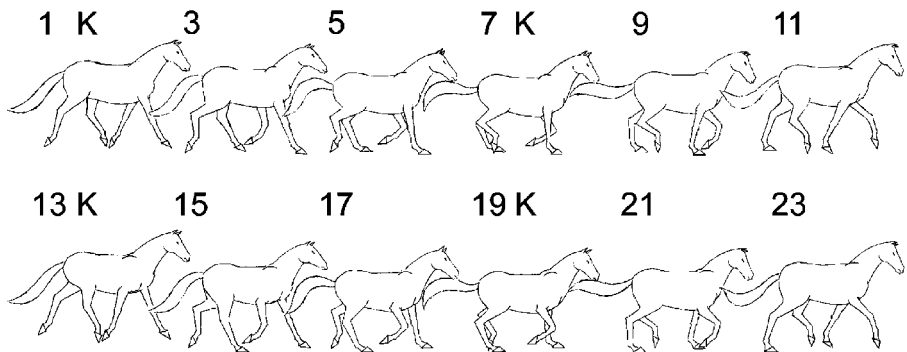

When the horse lands after the little jump, the fetlock absorbs most of the weight, by bending. With each of the strides and cross overs the back moves up and down in a parallel movement.

When moving your horse from a walk to a trot, pick up one of the legs (it doesn't matter which leg) slightly earlier as it travels from a stride into the cross over. Move it through the cross over position slightly faster than a walk so that it catches up with the cross over at the other end of the animal. Then have it come down to the next stride at the same time as the stride at the other end of the animal. Take a look at `horse_trot_2D.avi` in `animations006`, `chapter006` of the CD-ROM.

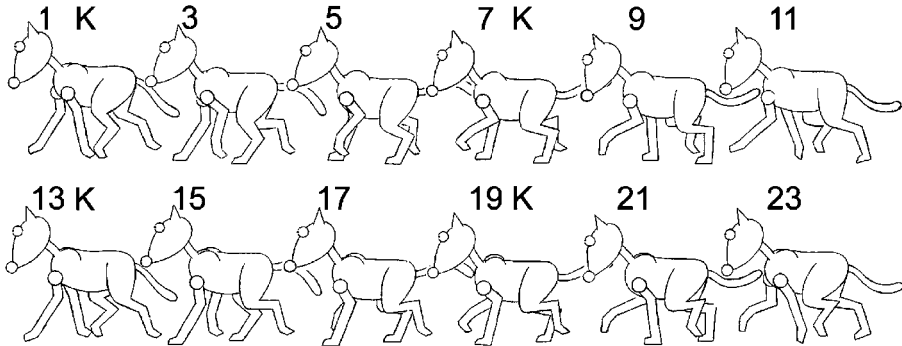

A dog trot will be very similar to that of a horse trot.

Take a look at `dog_trot_2D.avi` in `animations006`, `chapter006` of the CD-ROM.

### *cantering*

Have a look at `horse_canter.avi` in `movies006`, `chapter006` of the CD-ROM.

Two legs work in unison as a diagonal pair. The other two legs work independently. The fetlocks now compress more because of the greater force placed upon them as a result of the longer stride achieved.

The back is level when the diagonal pair of legs are in contact with the ground. As the two rear legs and the front leg of the diagonal pair lift off the ground, the horse's pelvic region is raised

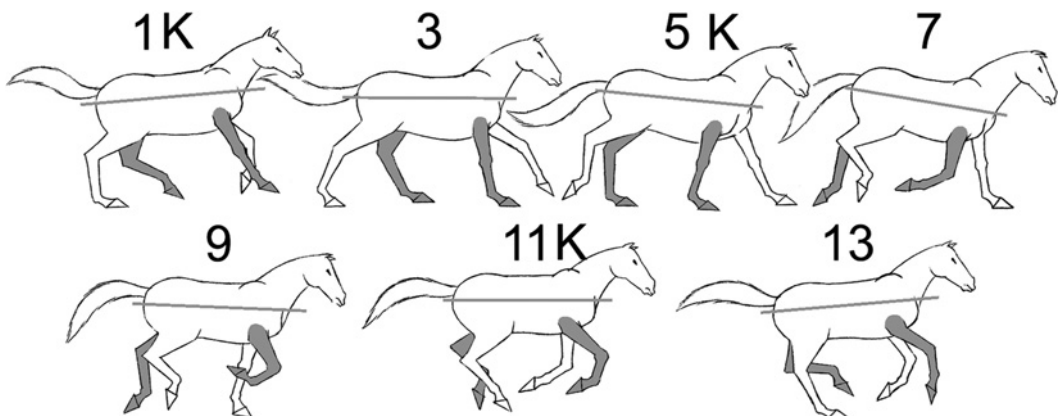

and the spine is tipped forward. When the front leg leaves the ground, we have all four legs in the air. At this point the backbone becomes level. As the first rear leg touches down on the ground the horse's pelvic region drops and the spine is tipped forward. As the diagonal pair of legs touch down onto the ground the spine becomes level! This gives the back a rocking motion. Take a look at `horse_canter_2D.avi` in `animations006`, `chapter006` in the CD-ROM.

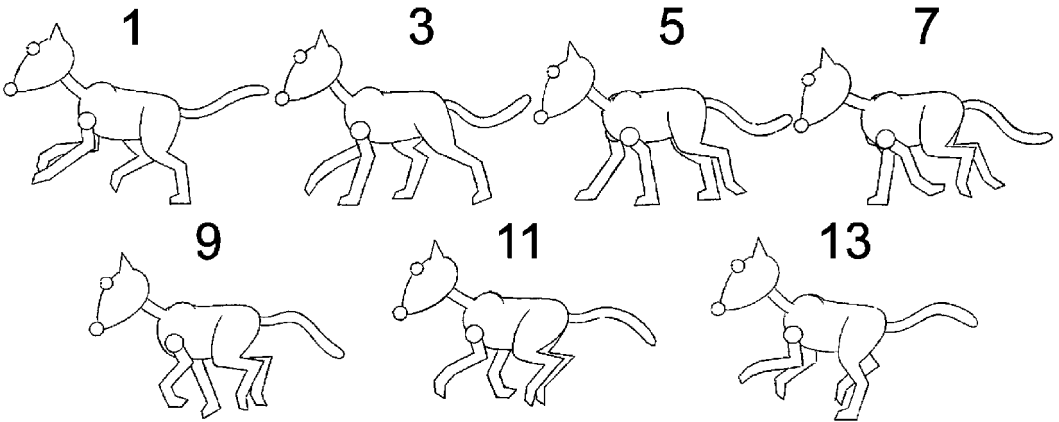

A dog canter will be very similar to that of a horse canter.

Take a look at `dog_canter_2D.avi` in `animations006`, `chapter006` of the CD-ROM.

## *galloping*

Have a look at `horse_gallop.avi` in `movies006`, `chapter006` of the CD-ROM.

All four legs touch the ground at different times, but essentially the front two legs work in unison with each other and the rear two legs work in unison with each other. The legs are slightly offset from each other.

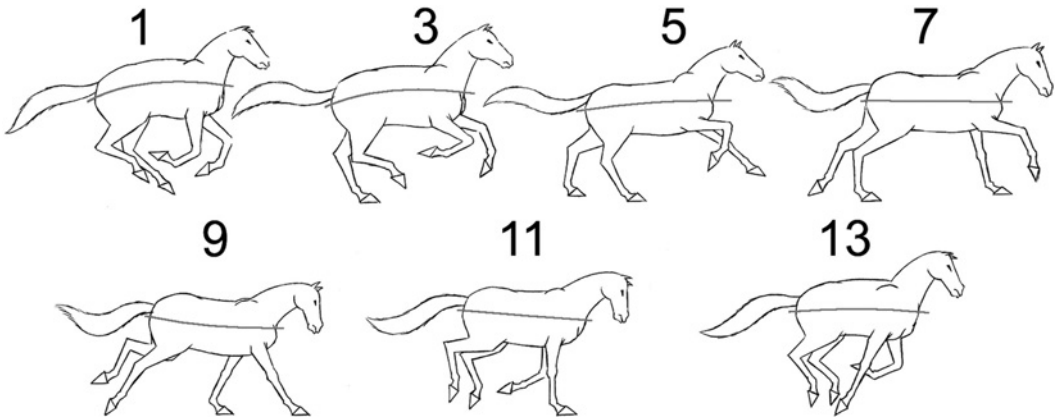

The spine will extend and stretch as long as possible at the point where the rear legs are in a stride position and the front legs are just about to touch down on the ground. At this point the front part of the body is at its highest. As the front legs leave the ground (when the rear legs

are in the air and trying to come as far forward as possible) the spine arches and curves over. At this point the horses pelvic region is at its highest. Take a look at horse\_gallop\_2D .avi in animations006, chapter006 of the CD-ROM.

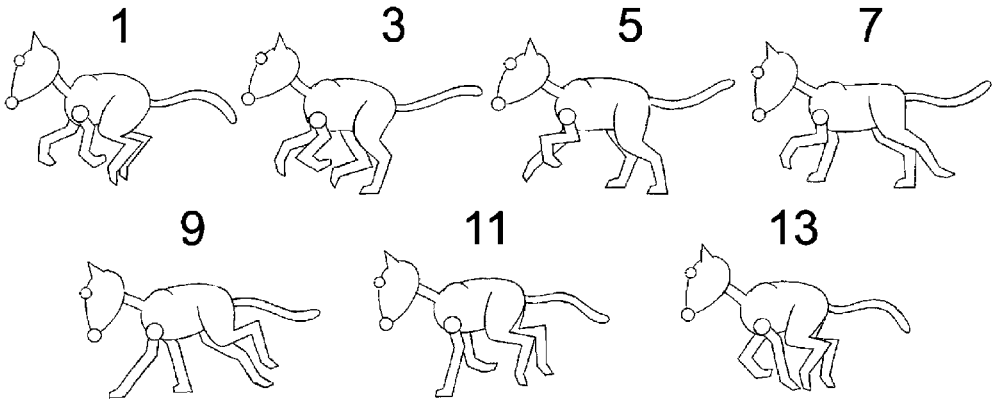

A dog gallop will be very similar to that of a horse gallop.

Take a look at dog\_gallop\_2D.avi in animations006, chapter006 of the CD-ROM.

### *transverse or rotary gallops and canters*

During a canter or a gallop, depending on whether front and rear legs on the same side lead or front and rear legs on the opposite sides lead, they can be referred to as a transverse (same side) or a rotary (opposite) gallop or canter.

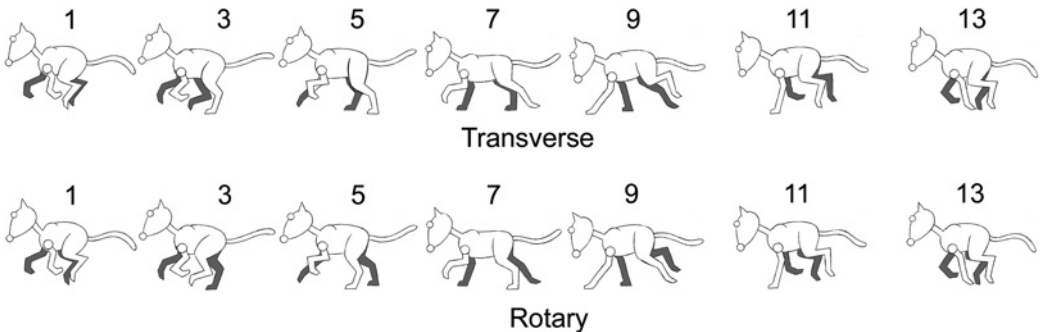

According to the experts, dogs and deer tend to carry out the rotary kind of canters and gallops whilst most other animals do the transverse form.

Having watched a few animals galloping and cantering in my time I can swear that I have seen horses and dogs doing both transverse and rotary gallops. The same can be said of most animals.

To be quite honest with you the whole visual experience of watching an animal gallop is so complicated that only an expert is going to question whether you have done the correct sort of gallop or canter for an individual animal.

Take a look at 'animal locomotion illustrations.pdf' on the CD-ROM for larger illustrations.



## exercises

### dog walk cycle in 2D

Take a look at the illustrations of the dog walk cycle and have a go at animating the dog walking or running on the spot (see first illustration in 'a dog walk' section).

First sort out the first two stride and cross over positions (for the dog walk these are 1 and 7). It can help to mark on the paper the positions where the feet will touch the ground. The stride at the back legs should be the same as the stride at the front legs.

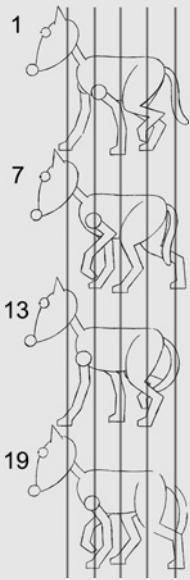

At the front of the dog, from frame 1 to frame 7, the foot in contact with the ground will slide back to a point that is half way between the front legs at frame 7. At the back of the dog the leg that is in the air will be put down onto the ground and the leg in contact with the ground will slide back into a stride.

The next two key positions to sort out are on frames 13 and 19. 13 is a mirror image of the drawing at frame 1 and is placed in the same position as 1. 19 is a mirror image of the drawing at frame 7 and is placed in the same position as 7.

Next, sort out the in-betweens. These should have the feet sliding back at a constant rate against the ground. Take a look at *dog\_walk\_2D.avi* in chapter006 of the is CD-ROM.

If you were animating your dog walking across the screen the position of the key positions would be as shown in this illustration.

Finally, have a go at animating a dog walking into screen, seeing something, coming to a stop, and galloping out of screen as a result of what they've seen.

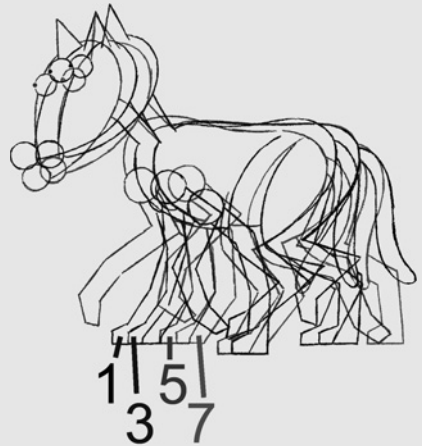
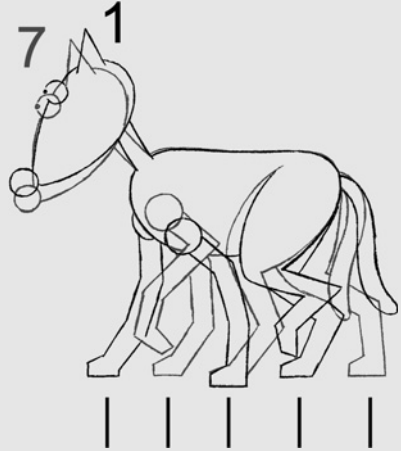

## *dog walk cycle in 3D*

Open up your chosen 3D software and load up either `maya_dog`, `lightwave_dog`, `xsi_dog` or `max_dog`. These are in the `dog_models` in chapter006 of the CD-ROM.

The 3D dog is constructed in a similar way to that of the 3D human. There is a circle running through the hips of the dog called `BodyControl`. This is used to pick up the whole dog or to rotate the hips.

There is a square (`FootControl`) and two diamonds running through each foot that controls the lifting and rotation of the foot and the rotation of the heel and toe. These are the same as the controls used for the human but there are four of them.

There are also two circles running through the shoulders. These control the rotation of the shoulder blades and are called `LShoulderControl` (left shoulder control) and `RShoulderControl` (right shoulder control).

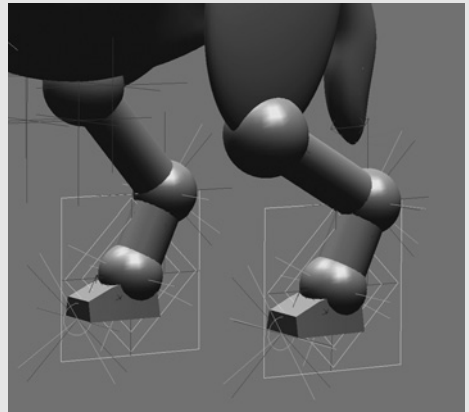
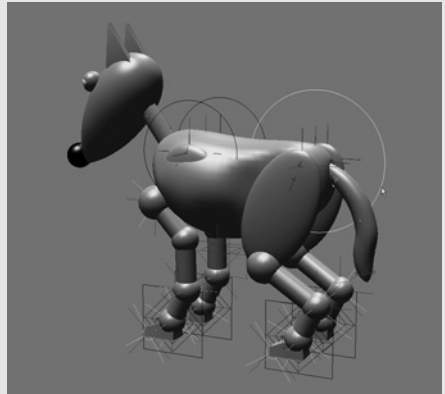

Between the shoulder bone and the back-bone there is a bone called a rib (`LribBone`

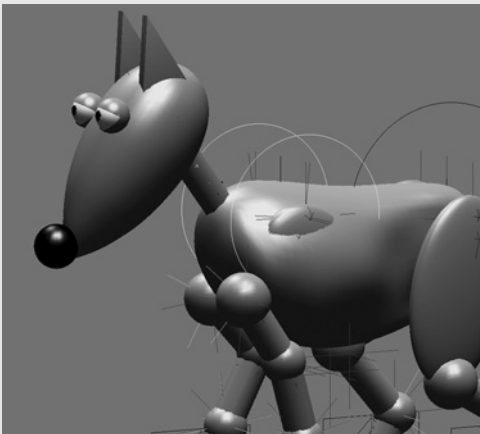

or `RribBone`). This controls the up-and-down movement of the shoulder bone, in order to replicate the sliding pivot effect that you get with shoulder movement.

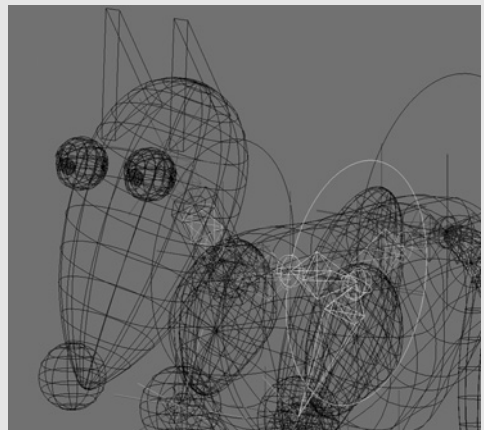

There are controls at the knees and elbows (LKneeControl and RKneeControl and LElbowControl and RElbowControl). These control the angle of the legs.

## *dog walk or run cycle in 3D*

Take out your drawings for the 2D dog walk cycle (or have a look at the first illustration in 'a dog walk' section) for reference.

To help with this create some small blocks and position them alongside the dog at 2 unit intervals (20 units for 3DS Max) as marks to guide where the feet will go.

Make the scene 1 frame longer than the drawn walk or run cycle and make the last key position at the last frame identical to the first key position at the first frame (just like the human walk and run cycles).

The dog walk is 24 frames long so the animation needs to be set to 25 frames long in SoftImage XSI and Maya (which start the animation at frame 1) and 24 frames long in LightWave and 3DS Max (which start the animation at frame 0). The first frame (frame 1 or frame 0) and the last frame (frame 25 or frame 24) are the same and have a stride at the front and a cross over at the back.

Move the feet forward or back or up or down by using the FootControls and rotate the ToeControls, HandControls and HeelControls. Remember to set keys on all the key positions.

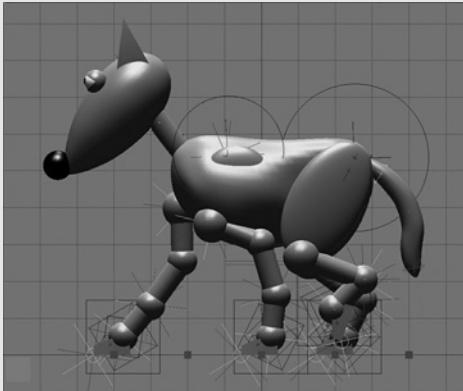

Frame 1 (0)

swapped. You can always make a note of the numerical position and rotation of one leg at frame 1 and then paste these numbers onto the opposite leg at frame 13.

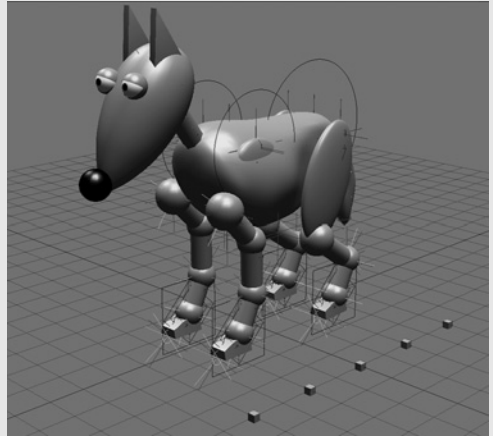

Next sort out the 'mirror image' key frame at frame 13. There is still a stride at the front and a cross over at the back but the legs are

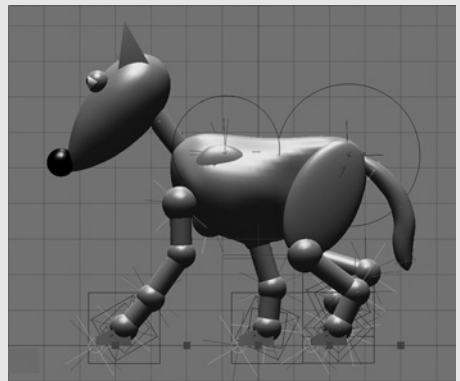

Frame 13 (12)

Once these are done do the other two key positions. These are at frames 7 and 19 (6 and 18 in LightWave and 3DS Max). These have a cross over at the front and a stride at the back and are the mirror image of each other.

The computer will in-between the legs reasonably successfully but the back is left ramrod straight. To alter this the next step is to do the breakdowns (the major in-betweens). Go to frame 3 and select the BodyControl and lift the body up. Save a key. Then rotate the BodyControl to position the front part of the body lower than the back. If you play back your animation you will have a dog that dips at the front as it puts all its weight at the front onto the leading leg. At the back it raises its bottom. Then go to frame 15. At this frame the body will be positioned exactly the same as frame 3. So select, move and rotate the BodyHandle so that the body is in the same position at frame 15 as at frame 3.

Next, sort out frames 9 and 21. These are where the front part of the body is higher than the back. Lower and rotate the BodyControl upwards to increase the height at the back.

Once these breakdowns are completed your dog will be walking, although the movement will probably be jerky. Select the BodyControl and go through the piece of animation frame by frame. Draw the position of each key and breakdown on the screen using a chinagraph pencil. Make sure that the body moves smoothly between each of these keys by either opening up the rotation animation curves for the BodyControl and adjusting them or by moving the BodyControl and setting a key on this movement.

If the feet sink into the ground, adjust by opening up the translation (move) animation curves for the FootControls. Make the curves straight between the key positions where the feet are touching the ground. Either move the curves with the bezier spline handles or make the curves linear.

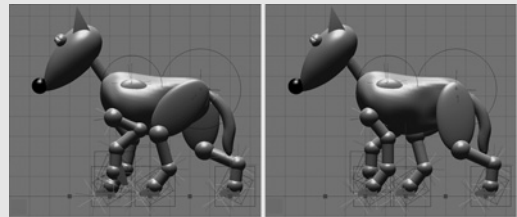

Frame 7 (6)

Frame 19 (18)

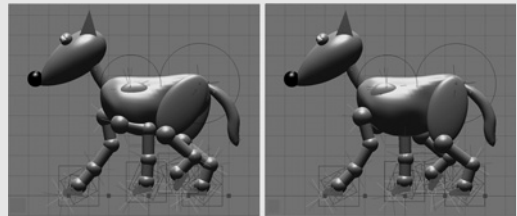

Frame 3 (2)

Frame 15 (14)

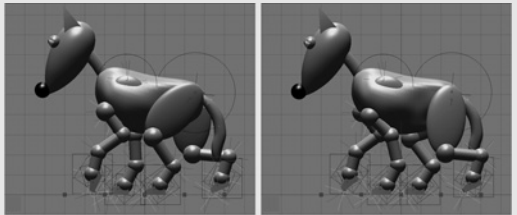

Frame 9 (8)

Frame 21 (20)

You'll probably need to move the knee and elbow controls outwards to stop the knees and elbows sinking into the dog's body.

When you render a movie of this animation only render frames 1 to 24 and loop the playback. If you include frame 25 the walk will pause at one point because frames 1 and 25 are the same.

The animation will accelerate out of key 1 and slow into frame 24, again causing a pause in the walk. To adjust this select any of the major components of the dog that are animated and open up the animation curves. Make sure that the curves going out of frame 1 and going into frame 25 match each other. Remember the movement at frame 25 continues on to the movement at frame 1 in a cycle.

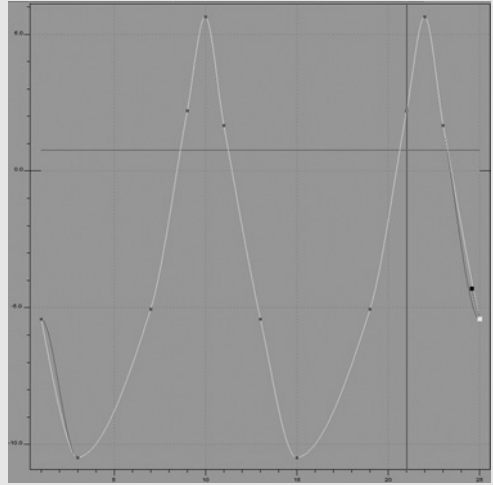

Adjust the tail by setting a key at frames 1 and 25 where the tail has swung out and then at frame 13 where the tail has swung in between the leg. Go through the animation two frames at a time. Rotate the bones inside the tail to move them into the correct position according to your drawn animation (or refer to the third illustration in the 'a dog walk' section).

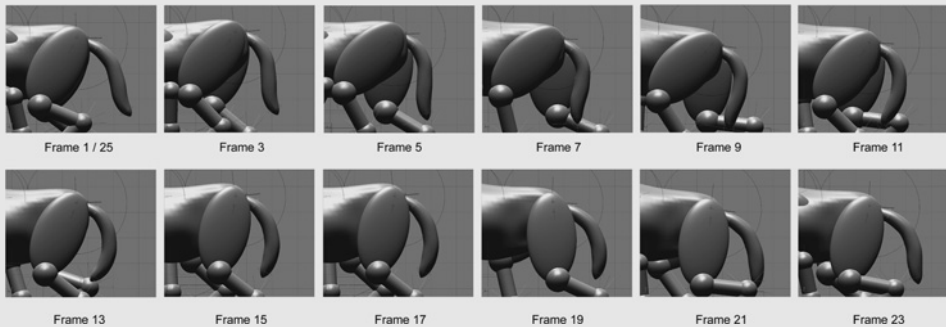

Adjust the head by placing it at its lowest point just after the front legs cross over and at its highest point just after the stride. Drag the head into higher or lower positions after each cross over and stride to stop it looking too repetitive.

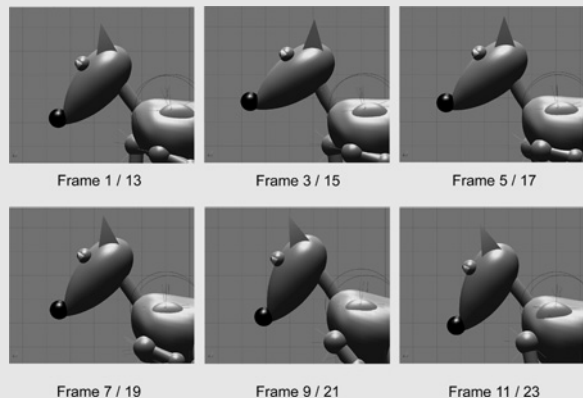

Take a look at dog\_walk\_3D.avi in animations006, chapter006 of the CD-ROM.

Have a go at a trot, canter and gallop as well and then take a look at dog\_trot\_3D.avi, dog\_canter\_3D.avi and dog\_gallop\_3D.avi in animations006, chapter006 of the CD-ROM.

If you're feeling very brave, have a go at a dog walking past a sign and changing its form of locomotion as a result of what it sees. Just like in Chapter 5.

## chapter 7

# animation of fish and snakes

### chapter summary

- *fish*
  - how they swim*
  - drag*
  - two swimming types of fish*
  - schooling (shoaling)*
  - swimming mammals and flatfish*
  - rays*
  - fins*
- *snakes*
  - basic movement*
  - concertina movement*
  - crotaline (sidewinder) movement*
- *exercises*
  - animation of a fish in 2D*
  - animation of a fish in 3D*
  - animation of a snake in 2D*
  - animation of a snake in 3D*

Not all animals propel themselves with the use of arms and legs. Some use their bodies.

## fish

Fish propel themselves through a fluid environment, which is very pertinent to the way that they move. They do this by flexing their backbone in such a way that a wave runs along the length of the body. As it travels

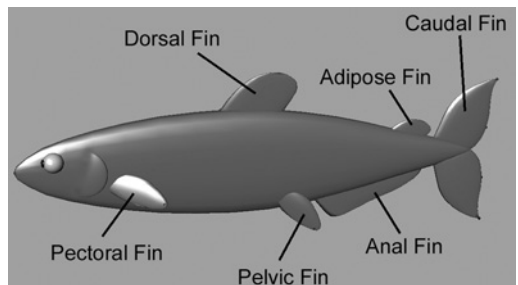

along the fish's body the wave gets bigger. This is called a sinusoidal wave! Take a look at *shark.avi* in *movies007*, chapter007 of the CD-ROM.

It's not unlike the flag cycle in Chapter 4. Think of the key positions as being at frames 1 and 9. These are the mirror image of each other. The breakdowns are at frames 5 and 13. Take a look at *fish\_wave\_2D.avi* in *animations007*, chapter007 of the CD-ROM.

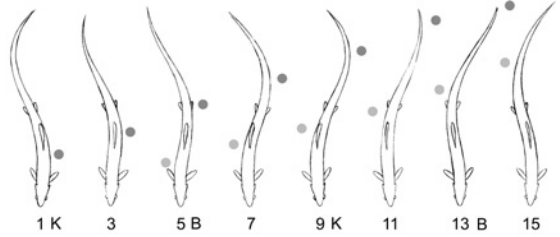

## how they swim

The density of water makes it very difficult to move in, but fish can move very smoothly and quickly. A swimming fish is relying on its skeleton for framework, its muscles for power, and its fins for thrust and direction.

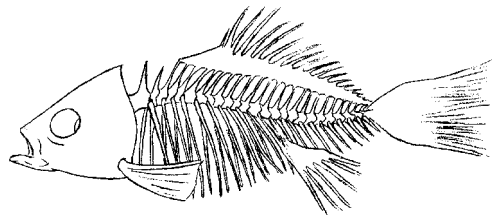

The skull acts as a fulcrum, the relatively stable part of the fish. The vertebral column acts as levers that operate for the movement of the fish. The muscles provide the power for swimming and constitute up to 80% of the fish itself. The muscles are arranged in multiple directions (myomeres) that allow the fish to move in any direction.

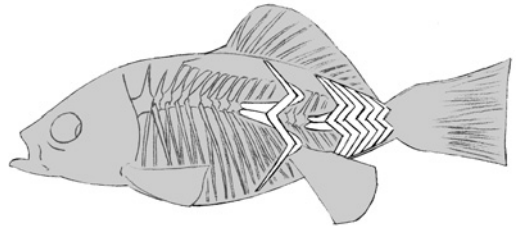

A sinusoidal wave passes down from the head to the tail. The fins provide a platform to exert the thrust from the muscles onto the water. This wave passes down the body on a vertical plane. The length of this sinusoidal wave along the fish's body is dependent on the structure of the fish.

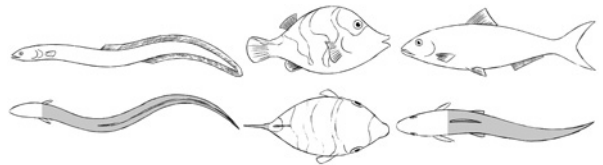

Fish have a swim bladder in their gut, which is basically a bag of air. This allows the fish to control its level in the water. Sharks don't have a swim bladder which means they need to swim constantly – otherwise they will float to the surface of the water (although I've seen many sharks resting at the bottom of tanks at aquariums).

## drag

Drag is minimized by the streamlined shape of the fish and the special slime they excrete from their skin. This minimizes fractional drag and maintains laminar (smooth) flow of water past the fish.



## two swimming types of fish

Fish swimming can be very simplistically broken down into two types of fish movement; 'cruisers' and 'burst' swimmers.

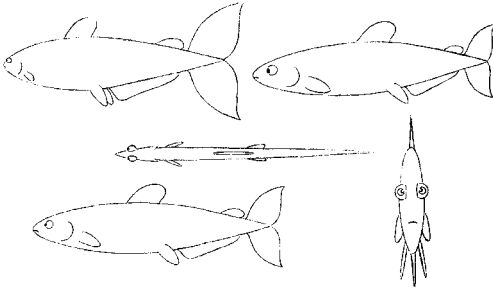

### cruisers

These are the fish that swim almost continuously in search for food, such as the tuna. They tend to be very streamlined in order to make swimming as easy as possible. These fish are likely to be found in a school (big group) for protection. Sharks are cruising fish but tend not to school.

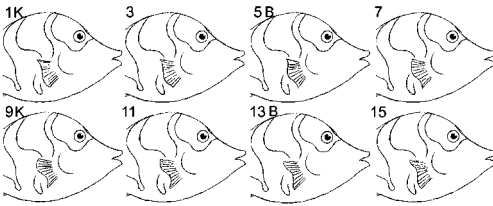

because they can hide more easily from predators. They will use their pectoral fins to maintain a stable position in the water.

If the fish is staying relatively still in the water, the fins will gently undulate in a 'flag cycle' motion. This helps the fish stay relatively still in the water. Take a look at fish\_fin\_2D.avi.

### schooling (shoaling)

A large number of fish will group together for company and protection, forming a school or

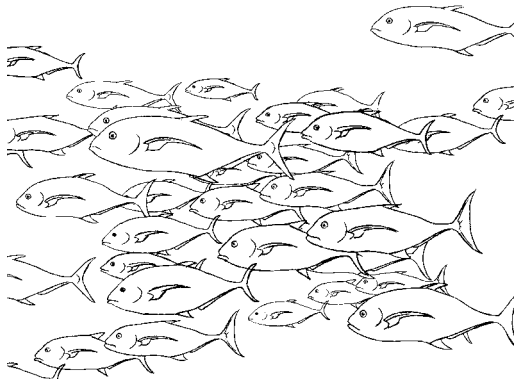

shoal. They will usually all be the same species. It's much harder for a predator to hunt a fish in a school, than when the fish is on its own. Predator fish, such as the piranha, will form schools in order to hunt larger prey. Schools of fish may be either polarized (with fish facing the same direction) or non-polarized (all going every which way).

When a fish swims along, it will follow a path of action with its body producing a sinusoidal wave to propel the fish.

When a fish turns, it will flick its tail into the corner that it is turning, a bit like the rudder of a boat. The flicking of the tail will swing the head into the turn. The body of the fish will stay slightly curved with the sinusoidal wave running through it as it completes the turn. Each swish of the tail will be greater on the inside of the turn than the outside.

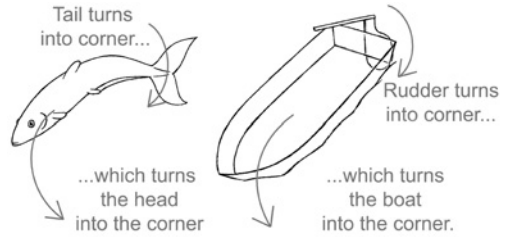

Before it does this turn it will usually flick the tail slightly outward first in order to anticipate this major swish of the tail inwards.

## swimming mammals and flatfish

Flat fish (plaice, Dover sole, etc.) are fish which live on their side. They do this because they live on the ocean floor. When they are born, they swim like any ordinary fish but as they grow they start to swim on their side and one of their eyes rotates round to what has now become the top of their body. They end up looking a bit like a Picasso painting! Take a look at *flat\_fish.avi* in *movies007*, *chapter007* of the CD-ROM.

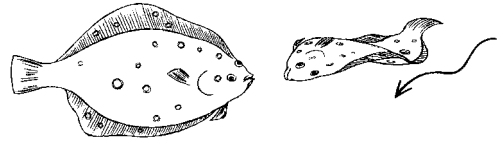

The sinusoidal wave passes down the body in a horizontal plane.

Mammals and birds that spend most of their time in water (for example, whales, dolphins, seals and penguins) also use a sinusoidal wave in a horizontal plane. Their flippers are used in a similar way to the fish's fins.

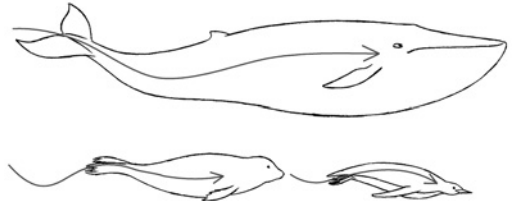

## rays

The ray family have flattened bodies, with gills on the underside of the fish and move themselves by undulating their 'wings' with a sinusoidal wave. Take a look at *ray.avi* in *movies007*, *chapter007* of the CD-ROM.

Have a look at *ray\_2D.avi* in *animations007*, *chapter007* of the CD-ROM.

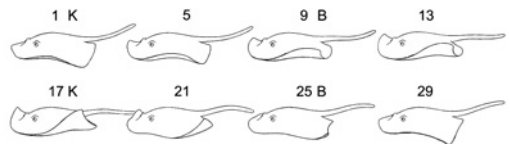

## fins

Fins give a fish control over its movements by directing thrust, supplying lift and even acting as brakes. A fish must control its pitch, yaw and roll.

### caudal fin

The caudal fin provides thrust and controls the fish's direction.

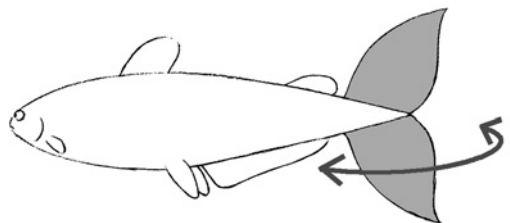

## pectoral fins

The pectoral fins mainly act as rudders and hydroplanes to control yaw and pitch. They also act as brakes by causing drag.

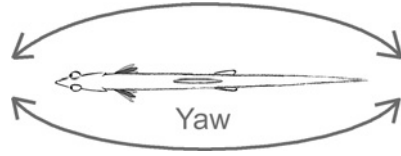

## pelvic fins

The pelvic fins mainly control pitch.

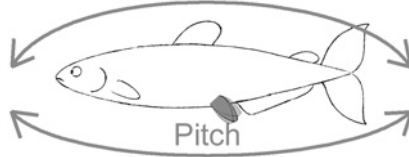
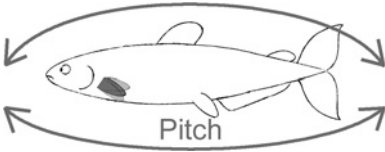

## dorsal/anal fins

The dorsal and anal fins control roll.

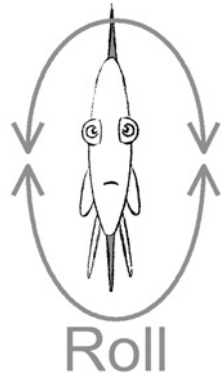

## snakes

### basic movement

Snakes have several means of propulsion. The basic method of locomotion is by wriggling the body using complicated muscles, ranged down either side of the backbone. The muscles are shortened on one side of the body, the contraction starting at the head and moving backwards along the length of the snake. Following this, a wave of contraction is sent down the other side of the body from head to tail. As a snake can be very long not all the muscles on one side are contracted at the same time with the effect that the body is thrown into horizontal waves, or undulation, as the muscles pull first to one side and then the other. These waves of contraction will expand and contract the ribs relative to each other. The scales on the under belly contract and expand as well. Take a look at snake.avi in movies007, chapter007 of the CD-ROM.

A snake follows a wave-like, looped path along the ground. If a snake is placed onto a smooth surface, such as glass, these movements fail to propel the snake anywhere since there must be something for it to push against. On ordinary ground, small surface irregularities will

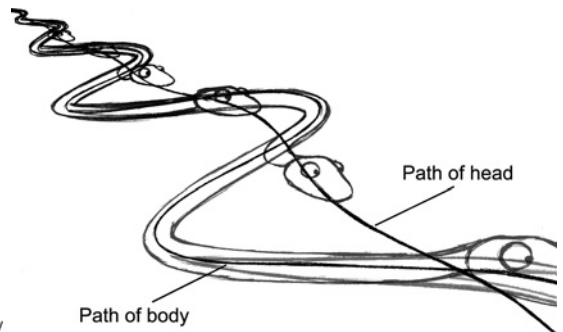
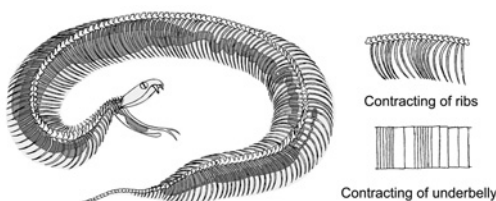

provide the necessary points of resistance. As the body undulates, the outer and rear parts of each body loop come into contact with the irregularities. Their resistance is sufficient to stop the loop moving backward on the ground and, as the snake is exerting muscular effort at this point, it propels part of the body forward. The result is usually, that, while the snake sends waves of contraction along its body and moves forward, the position of each loop relative to the ground remains stationary, the tail moving steadily along the track left by the head.

At its most basic a snake follows an undulating path along the ground. A snake will usually hold its head up and the head will follow a more direct path than the body.

Take a look at snake\_2D.avi in animations007, chapter007 of the CD-ROM.



### *concertina movement*

This is used by a snake to move through a confined space such as a tunnel or a hollow in the ground. As such it would rarely be seen in an animated film, but it's worth knowing about! This involves the snake making a concertina movement, throwing out loops at the front of the body to press against the walls and grip while they draw up the rear part of the body. The rear is then looped and pressed against the walls while the head end is straightened and moved forward.

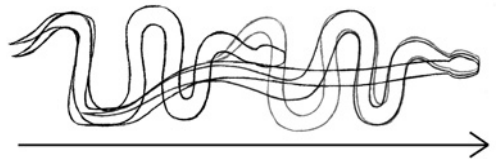

### *crotaline (sidewinder) movement*

In the shifting sand of deserts live vipers and rattlesnakes that employ a very different means of locomotion. This is known as crotaline or sidewinder movement. On loose sand it is impossible to get a proper grip with the sideways undulations that most snakes use, so sidewinder snakes move along by pushing downwards rather than horizontally. A snake that is side winding throws a loop of the front end of the body forward and places its neck on the ground. The rest of the body is then twisted clear of the ground, to lie in front of the head and neck in the direction that the snake is moving. The foreparts touch the ground first, followed by the rest of the snake and eventually the tail. However, long before the tail reaches the ground, the snake has thrown its head and neck to a new position forward and sideways and the rest of the body follows.

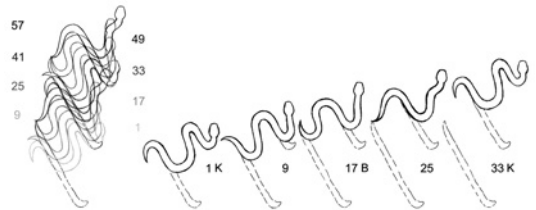

The result of this is that usually only two short lengths of the snakes body touch the ground at one time. It appears to be spiralling along sideways, leaving a series of tracks shaped like a capital J. The crook is where the neck was placed with the head facing forwards and the stem of the J is formed by the body, as it is brought forward in front of the neck. Lastly the crosspiece is made by the tail as it pushes clear of the ground. This takes about 32 frames and the same movement is repeated again as the snake moves along.

Take a look at *sidewinder\_top\_2D.avi* in animations007, chapter007 of the CD-ROM.

Take a look at *sidewinder\_side\_2D.avi* in animations007, chapter007 of the CD-ROM.



## exercises

### *animation of a fish in 2D*

#### **animating a fish on the spot**

To get a feel for how the fish moves animate a fish from above as a cycle. Take a look at the second illustration in the chapter. You may find that it helps to draw a wave shape through the fish and beyond its tail that gets bigger and bigger. Start with the first key position and then draw the mirror image of it. These will be at frames 1 and 9. Then do the breakdown drawings that go between each of these (frames 5 and 13). Finally do the in-between drawings (3, 7, 11 and 15), making sure that the wave moves through and along the length of the fish.

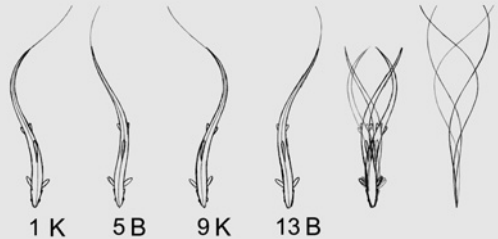

Take a look at *fish\_wave\_2D.avi* in animations007, chapter007 of the CD-ROM.

#### **animating a fish swimming through water**

Once you've animated a fish on the spot you can use these drawings as a reference for animating a fish swimming through some water.

First draw a path for your fish to swim along and then draw the basic key positions of a fish moving along this path. Don't put any details in at the moment and don't put any kind of sinusoidal wave on it. Just move a simple basic fish shape along the path and draw it in blue Col-Erase pencil.

Line test it and once the fish is moving along the path at a nice pace, in-between it. Take a look at *fish\_swim\_rough\_2D.avi* in animations007, chapter007 of the CD-ROM.

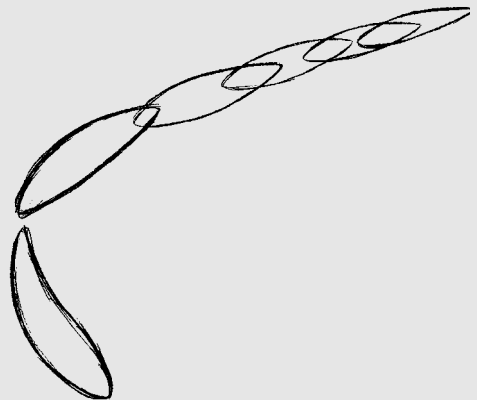

When you are happy with the speed of your fish, start to add the sinusoidal wave. Do this by copying your fish cycle animation and just copy the key and breakdown positions

first (the ones at frames 1, 5, 9 and 13), but try to imagine the fish rotated round so that it looks correct on your path. When you get to frame 17 on your fish animation, copy frame 1 from your fish cycle and so on.

Take a look at `fish_swim_breakdowns_2D.avi` in `animations007`, `chapter007` of the CD-ROM.

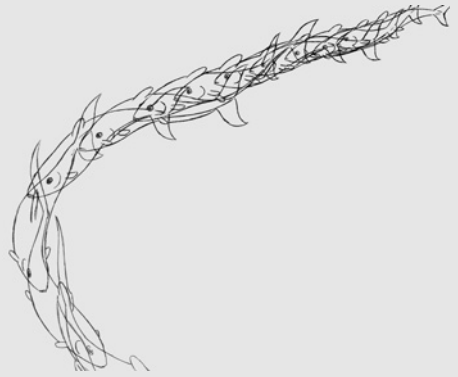
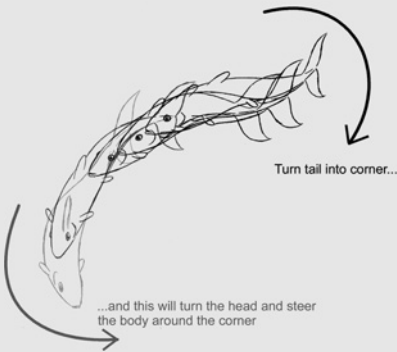

At the sharper corners, angle the tail of the fish in towards the turn.

Once this line test looks OK, in-between it.

Take a look at `fish_swim_2D.avi` in `animations007`, `chapter007` of the CD-ROM.

### *animation of a fish in 3D*

Copy the folder that contains your model (`3dsmax_fish`, `lightwave_fish`, `maya_fish` and `xsi_fish`) onto your C drive (in the case of `xsi_fish` copy it into the data folder). Open up `max_fish.ma`, `maya_fish.mb`, `xsi_fish.scn` or `lightwave_fish.lws`. The fish model has a series of bones running through it from the back of the head to the tail. With these you can make the sinusoidal wave run through the fish's body. These are called `Bbone01` to `18`. There is one bone through the head called `HeadBone`. It also has a circle running through its head called `BodyControl`. You can move the fish up, down and sideways and rotate it with this handle.

The pectoral fins have bones through them called `RPectoralBone` and `LPectoralBone`. Rotate these to move the pectoral fins. The pelvic fins have bones called `RPelvicBone` and `LPelvicBone`. Rotate these to move the pectoral fins.

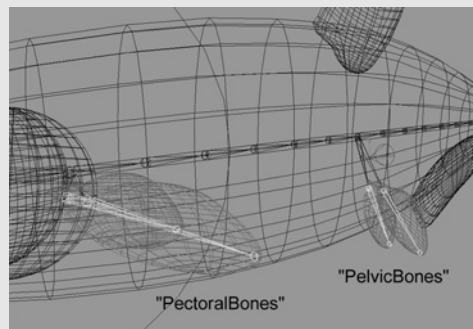
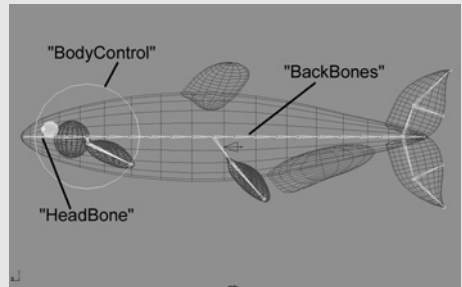

The eyes are controlled by a handle called EyeControl, just like the man and the dog.

### animating a fish on the spot

First have a go at animating a 3D fish on the spot. Take out your drawings of your fish cycle (or have a look at the top illustration on p. 159 and middle illustration on p. 164). Load up your 3D fish from chapter007 of the CD-ROM.

In your chosen 3D program, view the fish from above. Set your piece of animation to be 17 frames long. Move the time/frame slider to the first frame (frame 1 in Maya and XSI, frame 0 in Max and LightWave) and take out the first drawing from your fish animation. Select each of the bones through the fish's back and rotate them to make the shape of your 3D fish similar to the shape of your 2D fish, setting keys as you go. Move the frame/time slider to the last frame (17 in Maya and XSI and 16 in Max and LightWave) and set a key just the same as the first.

Then move the time/frame slider to the next key position (frame 9 in Maya and XSI and frame 8 in Max and LightWave) and move the 3D fish to a position that is the same as frame 9 of your drawn animation.

Once these key positions are done do the breakdown positions at frames 5 and 13 of the drawn animation. These will be at frames 5 and 13 in Maya and XSI and 4 and 12 in Max and LightWave.

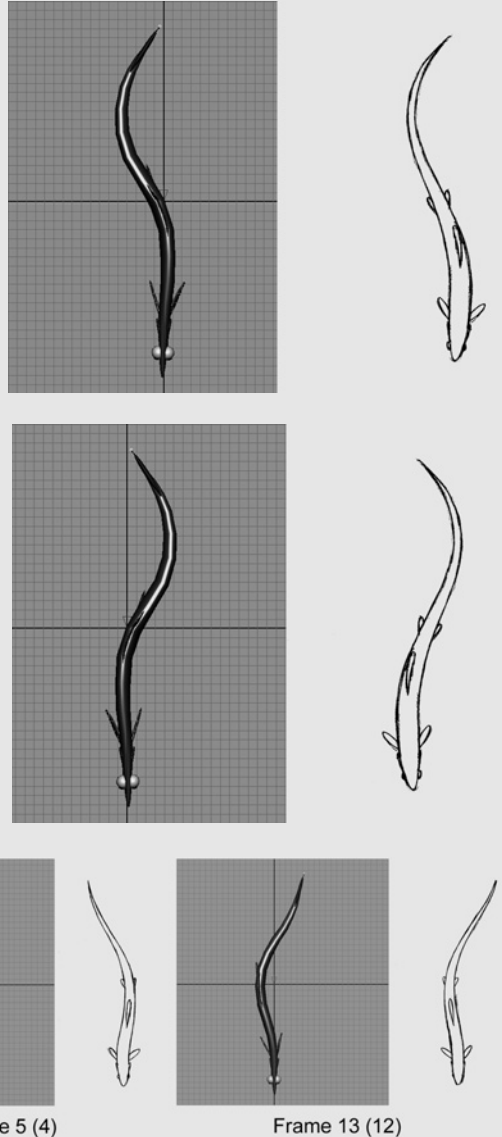

If you have followed your drawn animation of the top illustration on p. 159 and the middle illustration on p. 164 you should have a fish that is swimming in a fairly convincing manner.

Adjust the pectoral and pelvic fins so that they drag behind the body a little by rotating the pelvic and pectoral bones. Also get the tail to drag slightly by rotating the tail bones.

Have a look at fish\_wave\_3D.avi in animations007, chapter007 of the CD-ROM.

### animating a fish swimming through water

Now we need to have a go at getting our fish to swim through water.

Take out your drawn fish animation or have a look at the top illustration on p. 159.

In your chosen 3D program, load your fish model and select the top view. Zoom out a certain amount and set the scene length to around 65 frames.

Draw a curved path of action on the screen with a chinagraph pencil and move your fish to the start of this path and then save a key frame at frame 1. Move the time/frame slider to frame 35 and move the fish along the path to a point where the path changes direction and save a key frame. Then move the time/frame slider to the last frame of your scene and move the fish to the last point on the path and save a key frame.

If you play back your animation, the fish will travel through space and do a broadside type slide around the corner. Don't worry; we'll sort that out later.

We now need to put the sinusoidal wave through the fish.

Look at your drawn animation of the fish cycle (or have a look at the second illustration in the chapter). Put in the key frames first. These happen at frames 1 and 9 of the fish cycle. Go back to the first frame of your 3D animation and then re-shape the body of the fish like frame 1 of the fish cycle. Then go to the ninth frame of your 3D animation and re-shape the fish like frame 9 of the fish cycle. Then go to the seventeenth frame of your 3D animation and make the fish look like frame 1 of the fish cycle. Then go to the twenty-fifth frame of your 3D animation and reshape the fish like frame 9 of the fish

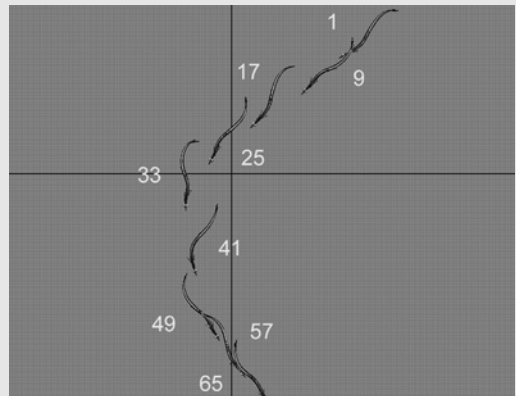
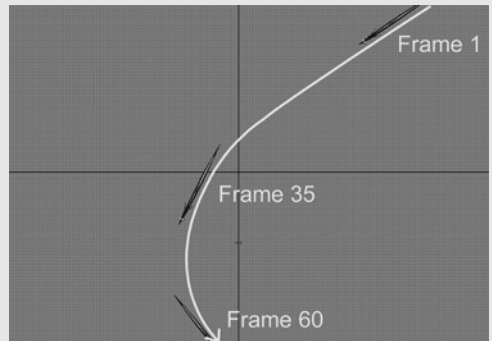
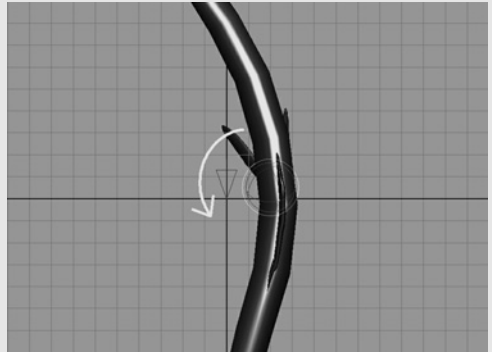



cycle. Continue through your 3D animation like this.

When you get to a corner remember to kick the tail fin into the corner more, then move the head round and with a slightly twisted body, continue the sinusoidal wave through the fish until the corner is completed. Then straighten the fish.

Once the keys are done, go back and do the breakdown positions. These correspond to frames 5 and 13 of the fish cycle. Copy these for each relevant frame on your 3D fish. (The shape of frame 5 of the fish cycle should be copied onto the fifth,

twenty-first, and thirty seventh frames of the 3D fish and frame 13 of the fish cycle should be copied onto the thirteenth, twenty-ninth and forty-fifth frames of the 3D fish).

Hopefully you will end up with something like fish\_swim\_3D.avi in animations007, chapter007 of the CD-ROM.

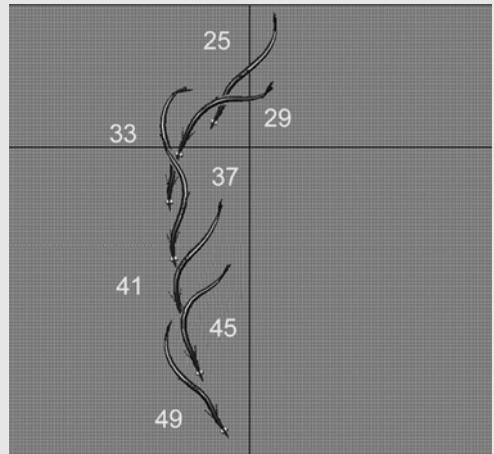

## *animation of a snake in 2D*

To animate a 2D snake, first work out a path that the snake will follow. Take a look at the bottom illustration on p. 162.

Draw a snake at successive key positions along the path. Make sure that it is fairly long. The shorter the snake the harder it is to animate.

Remember that the head is held up slightly and follows a far less exaggerated path than the rest of the body. To give the snake more character, have it look to one side and then to the other. This will make it seem less mechanical!

Take a look at snake\_2D.avi in animations007, chapter007 of the CD-ROM.

When you've done this have a go at a sidewinder!

It's probably worth animating the sidewinder from above to get the feel of its individual movement. Take a look at the bottom illustration on p. 163.

Start by drawing the first key position. Then lift the paper off the peg bars and trace this key a little further up, making sure it fits with the tracks left by the snake. This will be the key at frame 33.

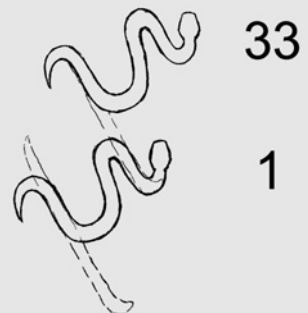

Do the breakdown at frame 17. This is positioned half way between the drawings at frame 1 and 33.

Go back and do the drawings at 9 and 25. Follow the bottom illustration on p. 163 for guidance.



Test it to see if it works, shooting each drawing for four frames. If the animation is successful, in-between it all again and shoot each drawing for two frames and hopefully you'll

end up with something that looks like *sidewinder\_top\_2D.avi*.

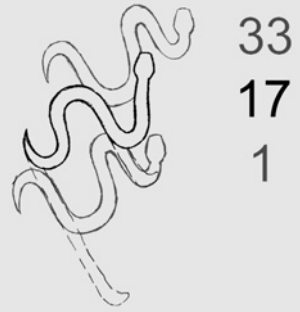

Once you've done the top view have a go at a side view. As with the top view start with the drawings at frames 1 and 33.

Then draw the breakdown drawing at frame 17.

Then do the drawings at frames 9 and 25. Look at the first illustration on p. 164 for guidance.

Test it to see if it works, shooting each drawing for four frames. If the animation is successful in-between it and shoot each drawing for two frames and hopefully you'll end up with something that looks like *sidewinder\_side\_2D.avi*.

### *animation of a snake in 3D*

The animation of a snake tends to be rather specific to each of the computer programs so have a look at the .pdf files; *3DSMax\_snake.pdf*, *LightWave\_snake.pdf*, *Maya\_snake.pdf* and *XSI\_snake.pdf* in chapter007 of the CD-ROM.

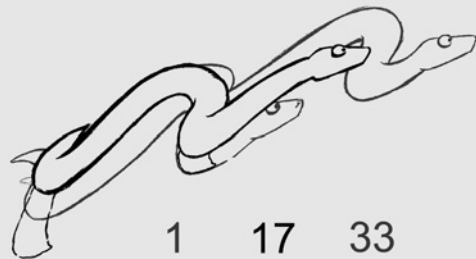
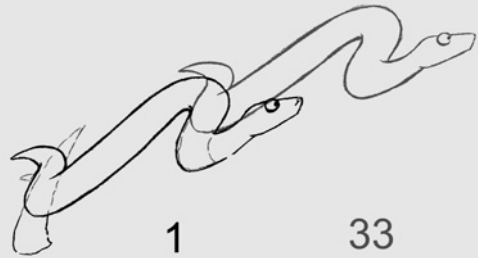

## chapter 8

# animation of birds

### chapter summary

- *flying*
- *wings – insects and humming bird*
- *exercises*
  - animation of a bird in 2D*
  - animation of a bird in 3D*

## flying

Birds are adapted for flying in several ways. Their forelimbs are specialized as wings covered with flight feathers; they have powerful wing muscles, a rigid body skeleton, light hollow bones, a large heart and a well-developed nervous system.

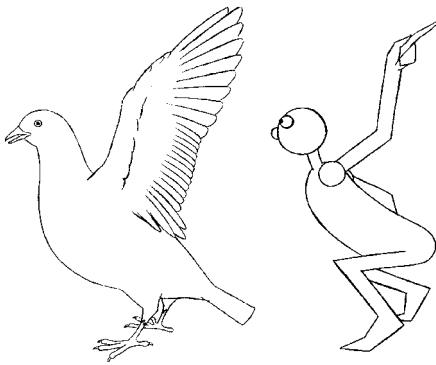

Think of the wings as being elongated arms (in the same way that you should think of the front legs of an animal as being like humans' arms).

In order to generate the power required to fly, a bird must have huge wing muscles. These wing muscles make up about 40% of the weight of a bird.

In order to anchor the huge wing muscles there has to be a keel at the front of the rib cage. This is called the sternum.

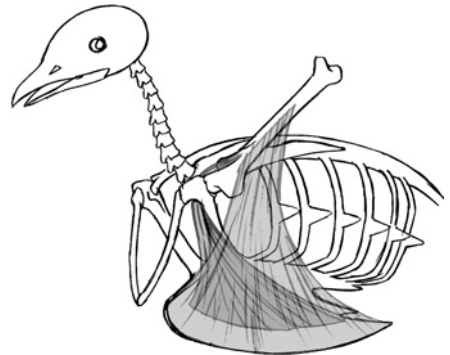
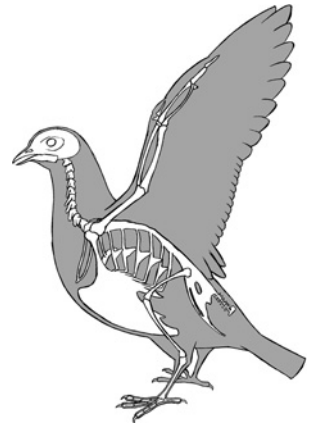

There is also a system of air sacs within the bones and between the body organs that provides extra air for the increased respiration while the bird is in flight. Consequently birds of the same volume as a non-flying animal are far lighter in weight. This gives lightness to the way that they move. The wings are concave below and convex above and have a thick front (leading) edge tapering off to a thin trailing edge, like the wings of an aeroplane.

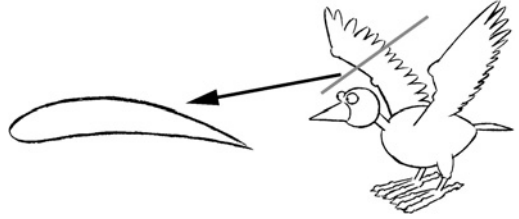

They provide the initial lift to launch the bird in the air, and then give it forward propulsion through the air. Birds take off with a jump or short run, preferably into the wind, followed by powerful semicircular beating of the wings, which produces lift on the down-stroke and forward thrust on the up-stroke.

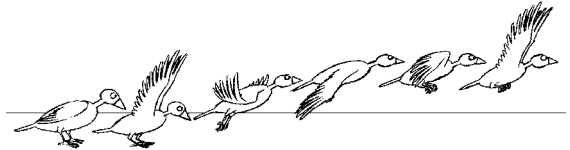

After gaining height the wings move with an up-and-down flapping, with the lift and thrust coming from the down-stroke.

I always find it looks better if the body of the bird falls on the up-stroke (no downward propulsion) and lifts on the down-stroke (lots of downward propulsion). The key positions are at the extremes of the movement. These are when the wings are pointing upwards and the body is at its lowest position in the air and where the wings are pointing downwards and the body is at its highest position in the air.

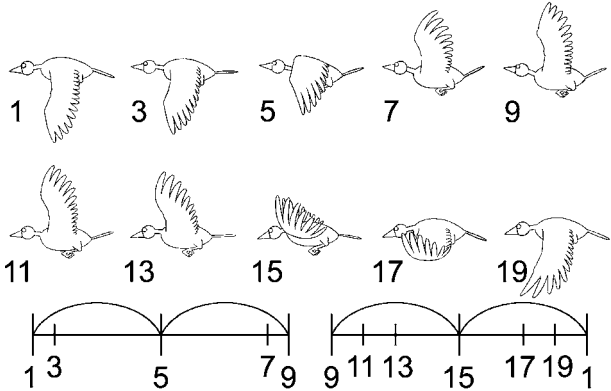

Waterfowl, such as ducks and swans, have greater difficulty in taking off from water as there isn't a firm surface to push from. The downward thrust causes the water to move – giving less air resistance. To overcome this they raise themselves with much more wing flapping.

In the case of this flying cycle the key positions are at frames 1 and 9. There are three in-between drawings between 1 and 9 (the up-stroke) and five in-betweens between 9 and 1 (the down-stroke). Take a look at `bird_flap_side_2D.avi` in `animations008`, `chapter008` of the CD-ROM.

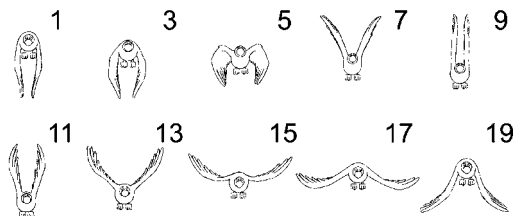

Sometimes I like to think of flying as swimming through the air. The wings have to force as much air as possible downwards and backwards on the down-stroke and then have to cause as little wind resistance as possible on the up-stroke.

When flapping downwards the wing will spread open to push as much air as possible backwards and downwards. When moving upwards, it will tuck in on itself in order to cause as little air resistance as possible. The tail helps to steer and the legs are tucked out of the way making the body smooth and streamlined. Take a look at `bird_flap_front_2D.avi` in `animations008`, `chapter008` of the CD-ROM.

The tail tends to be angled down on the down-stroke and up on the up-stroke. This is partly because the tail is following through the action of the bird's body. The head does something similar.

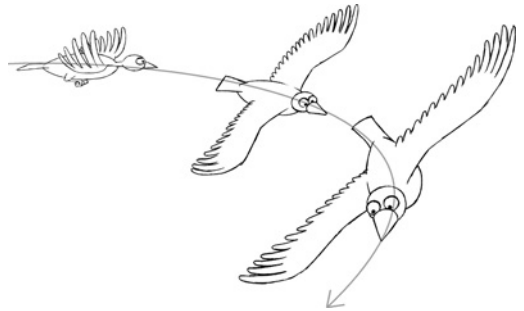

When turning a corner in the air a bird will bank like an aeroplane. This involves angling the wings. The wing on the inside of the curve will be lower than the wing on the outside of the curve. This can happen when the bird is gliding with the wings outstretched or while flapping.

When landing, a bird slows down by widening its wings and tail and pushing its body vertically downwards to act as an air brake. It will also flap its wings faster to gain more thrust.

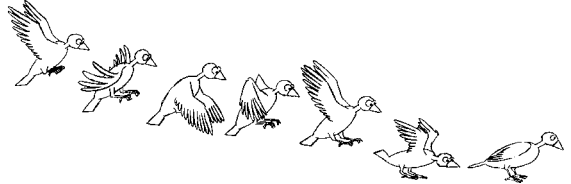

## wings – insects and humming bird

The wings on these animals move very fast! Anywhere between 60 to a 100 wing-beats per second.

With a frame rate of 25 frames per second only a fraction of the movement is ever going to be caught. This means that you have got to give randomness to your animation. You will also need to blur the wings.

You can do this by giving the impression of catching the position of the wings in a single frame with indications of their position a fraction of a second before.

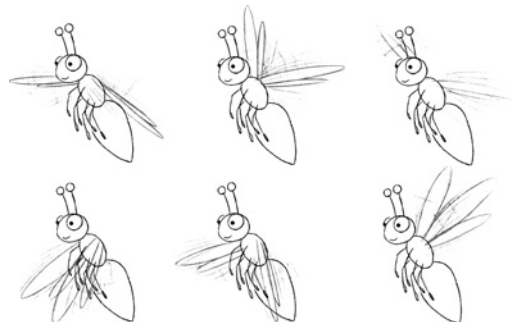

To produce an insect flying and hovering, use repeated, translucent images of the wings on

each frame in order to give a blur. Work out between four and six different wing shapes, and shoot these at random. Take a look at *fly\_flap\_2.avi* (the main problem with this piece of animation is that the fly looks like it is nailed to the spot. The body really needs to float around a bit to give a proper idea of hovering).



To get an insect or humming bird to fly around the screen, animate the body first and then add the random wings later.

## exercises

### *animation of a bird in 2D*

#### **2D bird flying on the spot**

First off we will animate a bird flying on the spot, performing a flapping cycle.

Take a look at the sixth illustration. Copy each of the key positions and make sure your bird bobs up and down. The highest key position is at frame 1 (where the wings are down) and the lowest key position is at frame 9 (where the wings are up). Make sure the bird stays on the same vertical plane. Have the head follow the movement of the bird's body but about four frames (two drawings) late.



The first breakdown is at frame 5. This is where the wing is on the up-stroke and is tucked in to cause minimum wind resistance. The second breakdown is at frame 15. This is where the wing is on the down-stroke and is trying to push the maximum amount of air downwards.

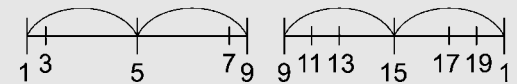
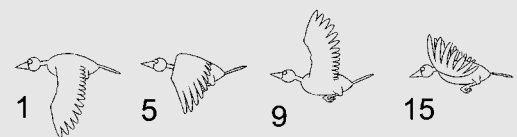

Consequently the wings are stretched out as far as possible.

In-between these drawings according to the timing charts, making sure the feathers trail downwards on the up-stroke (between frames 1 and 9) and upwards on the down-stroke (between frames 9 and back to 1).

Test it and hopefully you will have something that looks like *bird\_flap\_side\_2D.avi* in *animations008*, *chapter008* of the CD-ROM.

## 2D bird flying through the air

For our next exercise we are going to animate a bird flying along a path. Take out the animation of your bird flying on the spot for reference (or have a look at the sixth illustration).

First draw a path of action for your bird to follow. Then draw the key positions of the bird along the path.

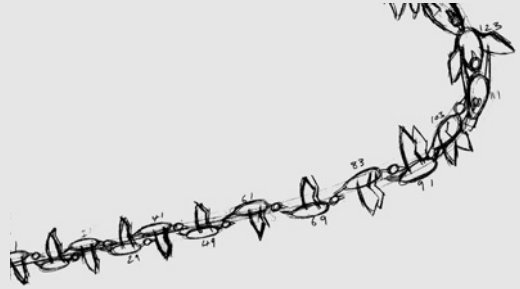

Draw the breakdowns and in-between it as with the animation of your bird flying on the spot (or the sixth illustration).

Hopefully you will end up with something like `bird_fly_2D.avi` in `animations008`, `chapter008` of the CD-ROM.

## *animation of a bird in 3D*

Copy the folder that contains your model (`3dsmax_bird`, `lightwave_bird`, `maya_bird` and `xsi_bird`) onto your C drive (in the case of `xsi_bird` copy it into the data folder). You will find them in the `bird_models` folder in `chapter008` of the CD-ROM.

Load up `maya_bird.mb`, `max_bird.max`, `lightwave_bird.lws` or `xsi_bird`.

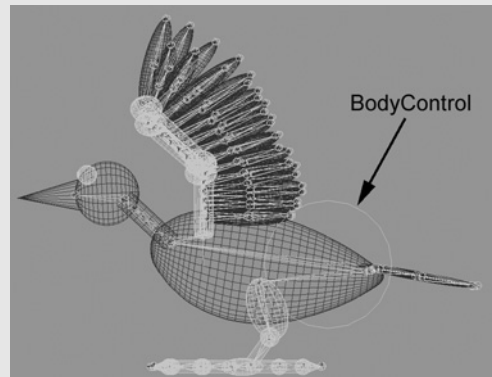
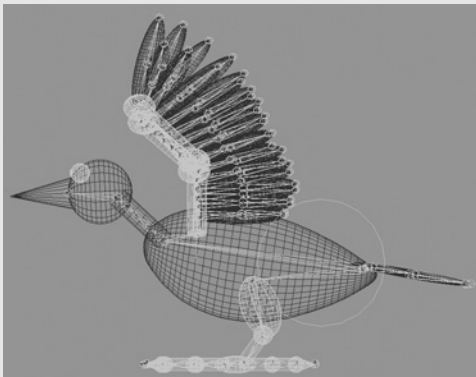

The model consists of a body with a single bone running down its length and a circle at the back called `BodyControl`. Selecting this will move and rotate the entire bird.

At the junction between the wings and the body are two further circles called `LeftWingControl` and `RightWingControl`. Selecting and rotating these will make the wings

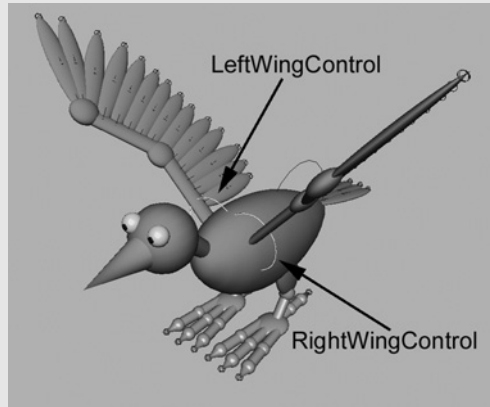
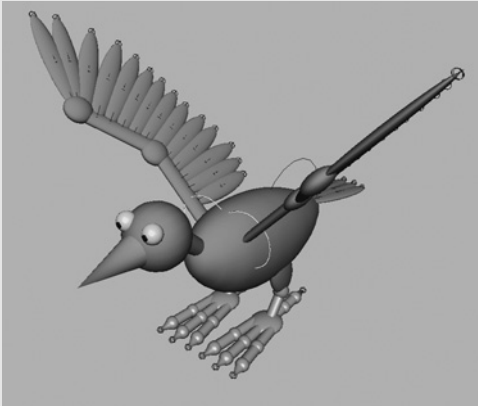

flap up and down. The wings consist of an arm shape with lots of feathers attached to it. Rotating the joints of the arm will move the arm and the feathers.

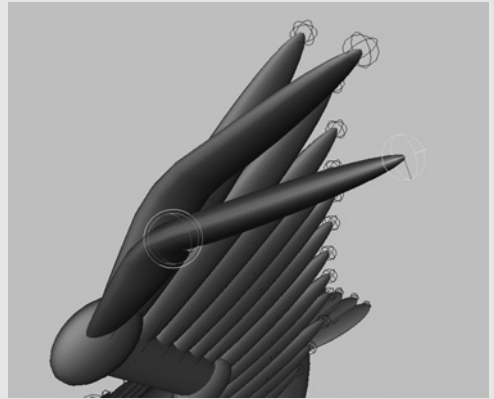
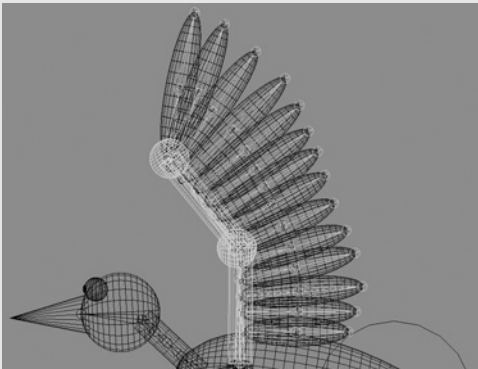

The feathers have two bones running along their length. Rotation of these bones will bend the feather.

There is no inverse kinematics on this model. That means that to move the wing, you have to rotate all the joints of the wing from the lowest joint upwards rather than from a handle at the top of the wing (as with the handle at the end of the arm on the model of the man).

The eyes are controlled by a handle called EyeControl, just like the man, dog, snake and fish.

### 3D bird flying on the spot

Take out your drawn animation of a bird flying on the spot for reference (or have a look at the sixth illustration).



We will make the 3D scene one frame longer than the drawn animation. End the new scene at frame 21 (Maya and XSI) or 20 (LightWave and 3DS Max). This will let us position the bird in the same place at the start and end of the scene as a reference point (as in the man and dog walk cycles and the fish cycle). Put the time slider/frame slider to frame 1 (Maya and XSI) or frame 0 (Lightwave and 3DS Max). Position your bird like frame 1 of your drawn animation. The body is at its highest position; the wings, head and tail are down. Set a key frame on all the parts you've moved. Move the time slider/frame slider to the last frame of the scene and set a key on every thing that you've moved.

Go to frame 9 (Maya and XSI) or frame 8 (Lightwave and 3DS Max) and copy the key position at frame 9 of your drawn animation. This is where the body is at its lowest point and the wings, head and tail are up.

When it comes to doing the breakdowns, between the first and second key frames the wing is on the up-stroke and has to be moved up quickly. Copy the drawing at frame 5 of your drawn animation onto frame 5 (Maya and XSI) or frame 4 (LightWave and 3DS Max). All the feathers will be bent downwards. Select the bones in the feathers and shape them as in drawing 5 (it will probably be worth saving key frames on all the feathers at the first, second and last key frames, so things don't get too confusing).

The next breakdown is at frame 15 of your drawn animation. This is where the wing is on the down-stroke and is spread out as far as possible. Bend the feathers upwards.

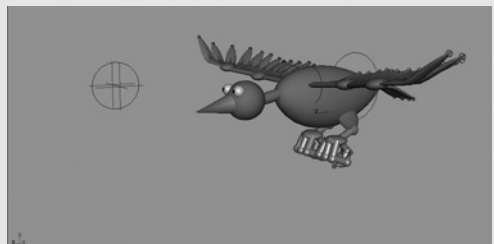
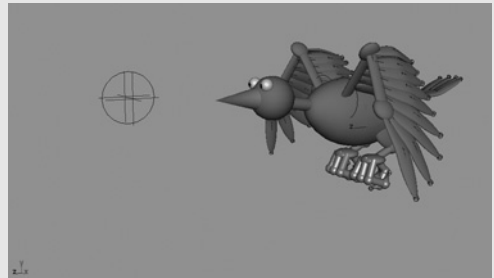
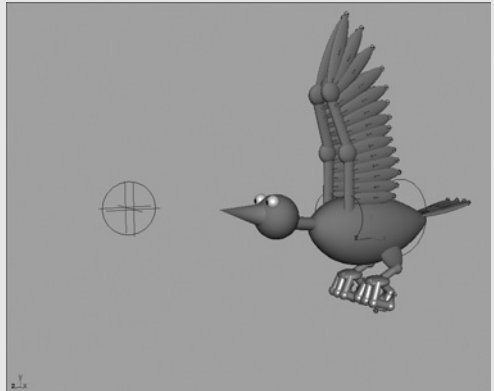
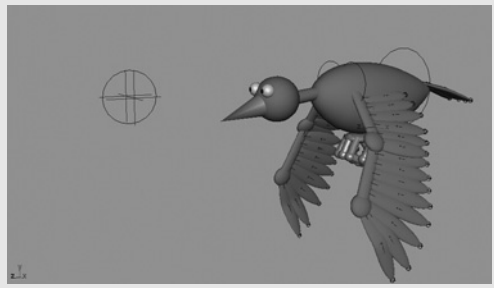

Once these are done you should only need some minor fiddling to sort out your animation. Render a movie one frame shorter than your animation (the last frame was for reference, remember?)

Have a look at `bird_flap_3D.avi` in `animations008`, `chapter008` of the CD-ROM.

### 3D bird flying through the air

With your drawn bird cycle as reference, plot a rough path for your bird to fly along. This can be done by drawing on the screen with a chinagraph pencil or using the drawing tool in your program. Draw a path which copies that of your 2D bird flying through the air.

The drawing tool in Maya is either the CV Curve Tool or the EP Curve Tool. Go to `Main Menu>Create>E P Curve Tool`. As you place the dots on the screen a line will form between them. When you have finished dotting, press enter (on your keyboard) to get out of this mode. Move the dots with the move tool until you have a path that roughly matches the path of your drawn animation.

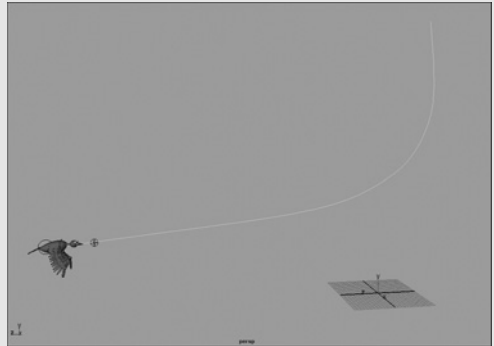

We are not going to attach the bird to the path. It is a guide for the flight path of the bird.

Select the `BodyControl` handle and set key frames at the equivalent key for your drawn bird cycle. Remember, the body is higher on one key frame than lower on the next, then higher and so on. Move the wings so that they are down as the body reaches its highest point and up as the body is at its lowest point.



Once this looks approximately right complete the breakdowns (wing on the up-stroke will be tucked in, wing on the down-stroke will be spread out).

Once this is done render a movie and it should look something like `bird_fly_3D.avi` in `animations008`, `chapter008` of the CD-ROM.

## chapter 9

# animation of acting – body language

### chapter summary

- *acting*
  - method acting*
  - theatrical acting*
- *consequence*
- *emotions*
- *introduction to Laban Movement Theory*
- *kinesphere*
- *space, time, weight and flow continuums*
- *eight basic efforts*
  - pressing*
  - flicking*
  - wringing*
  - dabbing*
  - slashing*
  - gliding*
  - thrusting*
  - floating*
- *general body language*
- *basic body postures*
  - open body postures*
  - closed body postures*
  - forward body postures*
  - back body postures*
- *responsive*
- *reflective*

- *fugitive*
- *combative*
- *palm, hand, arm and leg gestures*
  - palm gestures*
  - hand gestures*
  - arm crossing*
  - leg crossing*
- *acting out a scene in animation*
- *the use of video footage to help your animation*
- *the seven questions of character*
- *the different sorts of animatim acting*
  - animated radio*
  - pose-to-pose animation acting*
  - full animation acting*
  - mime*
- *analysis of a character*
- *exercises*
  - animation of acting in 2D*
  - animation of acting in 3D*
- *building a more sophisticated character*

## **acting**

Developing a sense of the dramatic will help with your ability to realize what you want your character to express. In the same way that all movement in animation must be exaggerated to make it more convincing, the same is true of animation acting. I've found that animation acting has more in common with theatrical acting than live action film acting. Theatrical acting has to be big and demonstrative for the audience to see and understand what's going on. The exaggeration required for this is similar to exaggerated cartoon movement. Whereas film acting requires a certain amount of restraint, the camera can cut right into somebody's face and a whole range of emotions can be put over with the movement of an eyebrow. This is something that animation finds very difficult to do. The closer you cut into the face of your character, the more obvious it is that your character is artificial.

There are many theories about acting but I'm going to concentrate on the ones that I've found most useful. These are method acting and more traditional theatrical acting.

## *method acting*

Think of this form of acting as constructing a character from the inside out.

Method acting is a style of acting that was developed by Konstatin Stanislavsky. He was a Russian actor, director and producer of stage plays and a founder of the Moscow Art Theatre in 1898. His book *An Actor Prepares* is well worth a read! The basic premise is that an actor lives and breathes the character of the part he is about to play so that when the actor's character is put in a given situation the character will react in a convincing way. This living and breathing of the character is carried out by workshops with other actors, the director making the actor act out spontaneous situations and also by the actor taking his roll home with him and acting the character out in real life situations. Imagine going out for the evening as King Henry the Eighth!

The actor is meant to use his or her own emotional experience and memory in preparing to live a role. So when an actor comes to reciting his lines the body language, intonation of voice and facial expressions will come naturally. It is a style of acting that is particularly suited to film. Quite often a camera will be left running while the actor acts out a scene, not knowing exactly how it will end. This 'acting on the hoof' can result in some very powerful performances. It can also end up looking rather ragged and messy depending on the actor's ability and plain good luck.

This form of acting training was carried on by Lee Strasberg at the Actors Studio in New York from the 30s onwards.

An actor using this method is likely to ask, 'what is my motivation for this scene?'

For animation this technique is useful for working out how your character would act in a given situation. Act out what your character would do in front of a mirror. Then use what you've learnt in your animation.

## *theatrical acting*

You can almost think of this form of acting as constructing the character from the outside in. The inspiration for the character to the actor is derived from the script. The director and the actor work out a series of positions and facial expressions to adopt while each line is read. Sometimes this form of acting is referred to as negative acting. Depending on the actor's ability it can seem over the top, or it can be breathtaking.

This technique is best used in animation to work out the main poses and facial expressions that your character will adopt during a scene.

## **consequence**

In real life any demonstrations of an emotion (body language, facial expressions and tone of voice) will be as a consequence of emotions being felt internally.

With method acting the body language, tone of voice and the facial expressions are as a consequence of genuine (or imagined) emotions being felt by the actor (by using their experience and memory to achieve these).

With theatrical acting the actor mimics the body language, facial expressions and voice intonations that are a consequence of emotions being felt in order to put over these to an audience.

Method actors are very disparaging of theatrical actors because of this mimicry. Theatrical actors are disparaging of method actors because they seem unable to act out a scene without knowing everything about the character they are playing.

Animators have to use both acting techniques. They have to understand the characters inside out and know how a character will behave in a given situation (this is the bit where an animator will act out the scene in front of a mirror). They then have to mimic the visible manifestations of these emotions (body language, facial expressions and tone of voice) in their animation.

## **emotions**

Emotions are the manifestations of conscious feelings. They can include feelings, an attitude, a state of mind of a character or a character trait.

Emotions can be divided up into three types, each of these types having a sliding scale of intensity.

Positive and negative. These emotions can range from happiness and excitement (positive) to anger, sadness or boredom (negative).

Engagement and rejection. These emotions can range from surprise and attention (engagement) to disgust and contempt (rejection).

Neutrality and high intensity. These emotions can range from calmness (neutrality) to being highly excited (high intensity).

Each of these three groups of emotions can be intermixed; for example, anger combined with contempt (negative and rejection).

Emotions can be experienced very briefly (for only a few seconds or fractions of a second) or for a long time. A mood could last for several days and an attitude or state of mind could last for a very long time. A character trait will be a part of the character's emotional make-up and will give a clue to the character's outlook on life. For example if a character is constantly miserable, they will have a sad or angry look on their face. Their shoulders will be stooped and their motions will be laboured.

Acting is the bodily expression of these emotions.

## introduction to Laban Movement Theory

One of the most useful things you can do as an animator is to take some drama classes. Actually learn about acting and movement and get somebody who knows what they are doing, teaching you. A lot of animators dismiss this approach, saying that you don't need to leap about and make a fool of yourself in order to animate. All I can say is that my animation has improved incredibly as a result of acting classes and any animator who doesn't try this is missing out.

Of all the drama techniques that I've studied, the most useful one I've found is Laban Movement Theory. This approach to acting and dancing was developed by Rudolf Laban (1879–1958). Laban was not only a choreographer, dancer and actor but also was interested in all forms of movement. He was involved in time and motion studies for industry and applied his theories using mathematics, geometry and drawing.

I'm not going to even try to cover all aspects of Laban's movement theory other than the absolute basics. The best thing you can do is to try and find a Laban movement class locally and do some exercises. Failing that you could look up the Laban Centre website ([www.laban.org](http://www.laban.org)) or buy the book *Laban for Actors and Dancers* by Jean Newlove. Remember, nothing beats doing the movement yourself to really take it in.

The great thing about Laban Movement Theory is that it makes you very body and movement aware. Through a series of exercises you will become familiar with the way the body moves and how external and internal influences can affect it. It also ascribes movements to things like character and emotion.

## kinesphere

Think of this as an area of personal space around the body. A bit like a large bubble. Within this the body can move forward backward, up down and left right. The body can also move diagonally across this space. In many ways this is a similar but more sophisticated way of thinking about movement than the idea of forward and backward and open and closed body positions. The responsive, reflective, combative and fugitive body postures.

Diagonal movements are more furtive because they will unbalance the body and either have to be completed quickly or some sort of counter balance will have to come into play. There will always be a specific reason for a diagonal movement or stance. To balance yourself while holding an object or pointing at something. Standing on one leg and adopting the necessary diagonal posture to remain balanced makes a person look vulnerable. It can also give a feeling of confidence in that person. It would be easy to push that person over, but the character is confident

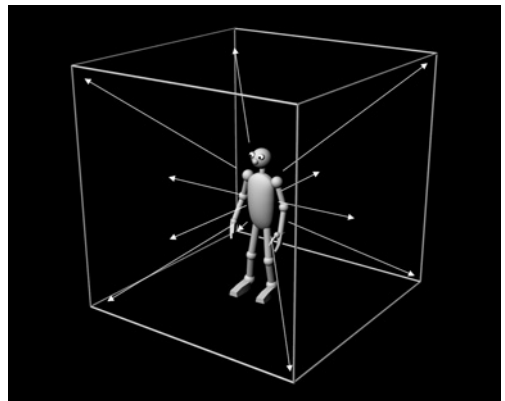

enough to know that that is not going to happen. Asymmetrical postures are always more interesting to look at than symmetrical. So use them as much as possible.

## **space, time, weight and flow continuums**

Anything we do involves the movement of our body through space. Often when life drawing a tutor will refer to the model as occupying space and it's that bit of space that you are drawing. When we leap about, or pull a facial expression or just breath we are moving in space.

Time is not only the amount of time it takes for an audience to understand a certain point you want to put across. It can also be the changing of the seasons, the phases of a human's life, the fast moving modern world or the slower idealised idea of a slower moving bygone age.

The depiction of weight is one of the fundamentals of producing a convincing piece of animation. A balanced person will look right, planted in the middle of you screen. An unbalanced person will look as if they are going to fall over, and if they don't fall over or correct their balance they will start to unnerve an audience. Within this you can also think about the other 'weight' a person may be carrying. The weight of responsibility, guilt or misery. They could also be affected by the lightness of relief, of a lack of responsibility or being in love.

Flowing movement could be said to be the continuous movement of one action into another. If your animation has too much flow it is difficult for an audience to define each of the individual movements and what they mean. A series of movements that stop and start could be described as jerky and again can be off-putting to an audience. It's always best to use a mix of approaches.

## **eight basic efforts**

Laban Movement Theory, divides movement up into eight basic 'efforts'. One way to give a scene you are animating more depth is to think which of these efforts applies to the personality of your character and the situation that they are in within the scene. Then have a go at physically doing these efforts yourself. Subconsciously you will take on board the movement required to do these efforts and this will be reflected in your animation.

It would be a good idea to practice each of these following movements first, individually and abstractively, just so you get a feel for them.

### *pressing*

This movement is direct, sustained and strong. It could be pushing or pulling something, lifting or leading something. It suggests a character that is determined and indefatigable. This movement could be applied to a determined person who has a definite goal.

### *flicking*

This movement is flexible, sudden and light. Small delicate movements of any part of the body, like flicking dust off your clothes or suddenly moving the head round to something that you hear. This to me sums up a more nervous person, twitching and reacting suddenly to things that happen to them.



## *wringing*

This movement is flexible, sustained and strong. This can be a movement like wringing out wet clothes but could also be interpreted as gut churning internal emotions within somebody who frightened or embarrassed. Somebody in inner turmoil, or somebody who is worried about something.

## *dabbing*

This movement is direct, sudden and light. A bit like flicking but with a directness to it. Like pocking somebody on the shoulder when you want to get his or her attention. This could be a busy body type person, bossing other people around.

## *slashing*

This movement is sudden strong and flexible. Think of it like slashing a sword in all directions, or slashing the arms about to escape from something. An angry person who is annoyed by everything and anything.

## *gliding*

This movement is sustained, light and direct. I think of this as being like the way a butler would glide, silently into a room, very confident and aloof. The movement has a definite direction to it. A quite, confident person who is in control of themselves and everything else (or who gives a good impression of it).

## *thrusting*

This movement is direct, sudden and strong. A bit like slashing, but with a definite direction to the movement. Like one person punching another or somebody punching the air. A person who exists on short bursts of energy, either aggressive or delighted.

## *floating*

This movement is flexible, sustained and light. A more dreamy feeling of movement, like this-tle down drifting in the air or a cork bobbing on the ocean. I picture somebody dreamily skipping through the woods, at one with nature.

Of course all the examples of characters I have given here are very one dimensional. Have a go at mixing and matching these efforts in order to define you character. For example, a character displaying both pressing and wringing efforts gives the impression of somebody who has a depressive personality. Have the character display pressing and floating and they seem rather dumb.

Once you've worked out a collection of efforts for the basic personality of your character, think of what efforts can be layered over the top for the individual scene that you are going to animate. Then try acting out what you character does, bearing in mind these actions.

As I've said before, doing this on your own, without the benefit of a drama or Laban coach is like taking a shot in the dark. Sign up for some classes and see how much it improves your animation.

## general body language

Sorting out the body language is the first thing you should do when animating a character. If you can put over what a character is thinking, looking at or doing just using body language, you are doing very well. When you add the facial expressions to your animation it will only get stronger.

We look at other human beings every day and we try to read from their facial expressions and body language what that other person is thinking and feeling. We've been doing this for almost every day of our lives and have become remarkably good at it. So good in fact that a large amount of this information is taken in subconsciously. We've all been in a situation where we've met someone who is all smiles and bon homie but there is something not quite right about them. Something a bit false, a bit dodgy. You could say that various door-to-door salesmen fit this category and the best ones are the ones that are able to get themselves into your confidence while not putting over the impression that they are trying to sell you something that you don't want! There must also have been times, for example at an interview, where you have not been able to come across as you would have liked. It may have been down to the fact that you were nervous and didn't come over as someone in control and confident.

In order to animate subtlety we have to become an anthropologist with a deep interest in all human beings.

A lot of puppet animation (and puppetry in general for that matter) relies purely on body language. The faces of puppets can't change expression to the same degree as drawn animation or 3D computer animation, but puppet animation and puppetry can be just as expressive (if not more so) as any other sort of performance. Watch puppet shows like the *Muppets* and animated films like a *Nightmare before Christmas* and see how the characters express themselves.

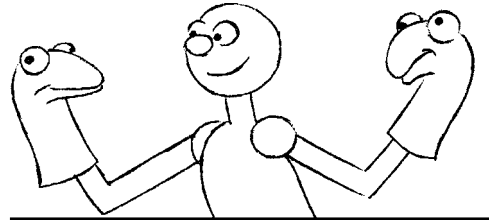

This is not to say that facial expressions are not important. Humans have the most expressive face of any animal and one of the main reasons that it exists is to communicate with other human beings. I like to think of the face as a canvas that different expressions are painted onto (more about faces in Chapter 10).

The one amazing thing about human beings is their ability to lie. We can be feeling miserable but we can still have a smile on our face. This ability to lie is at its best in the face. We can say that we are OK and we can smile to cover up another emotion. As we move down the body this ability to lie weakens. To put it bluntly our bodies are more honest. So if we are feeling miserable, we can put on a happy face. We may be able to hold our shoulders up when we want them to droop but there will be a strange strain to the position, perhaps they are held up slightly too high and are stiff in movement. As we move down the body the arms and hands could hang in a way that suggests that any movement is an effort. The small of

the back will want to bend outwards and if the character walks the feet will drag. Very corny I know, but all these little things can add up to telling your audience what a character is feeling.

## basic body postures

From the moment we wake up to the moment we go to bed we are spending our day reacting to things that we are presented with. Whether it's people, ideas, situations or problems, smells or sounds, everything we do is a reaction to something else. How we react to these situations is reflected in the body language we adopt. There are a huge amount of signals that can be given off by the positions adopted by different parts of the body. These postures can compliment each other or can contradict each other depending on the situation. For example, if somebody is depressed and openly expressing this the back will be bent and the body slumped forward, the shoulders will be slumped downward. The arms will be hanging down, the head will be hanging down with a sad look on the face and the legs will be bent at the knees, making the person look heavy. All off the different parts of the body are saying depressed and adding up to a whole look of depression. If the same person is depressed but wants to cover this up the head would be held up with a forced smile on the face, the shoulders will be slightly slumped down, the arms will be bent at the elbows but the hands will be limp. The back will be slightly bent but the legs will be very bent at the knees, making the person look heavy. Although some of the signals given off by parts of the character's body say something else, the majority of the signals say depressed and so the observer will still get an overall feeling of depression.

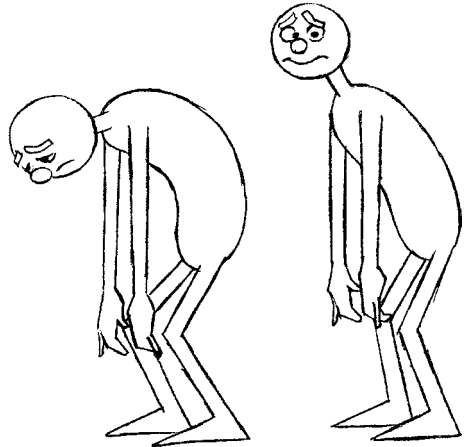

Generally there are four basic forms of body language postures, *open*, *closed*, *forward* and *back*. We use a combination of these postures to give out signals to other people. Remember, acting the emotion that your character is feeling in front of a mirror is always the best way to make the action clear to yourself. In order to keep things clear I have deliberately made the following illustrations as simple as possible.

## open body postures

These are indicated by the arms being apart, the hands shown open, the legs being apart with the feet planted on the ground and the body fully facing the object of interest. This shows that your character is reacting positively to the messages they are receiving.

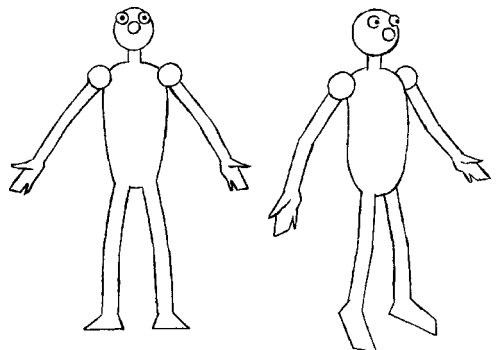

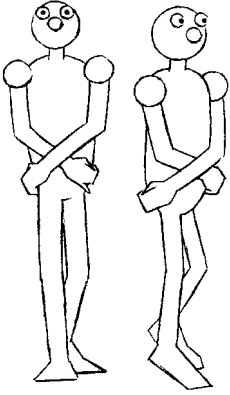

### *closed body postures*

These are when the arms are folded and the legs are crossed (if seated). The body may be turned away from the object of interest. The head might be lowered. This shows that your character is rejecting messages that they are receiving.

### *forward body postures*

These indicate that a character is actively accepting or rejecting a message given to them. When they are leaning forward and pointing toward something with a fist or a finger, they are involved,

absorbed or passionate about what they feel.

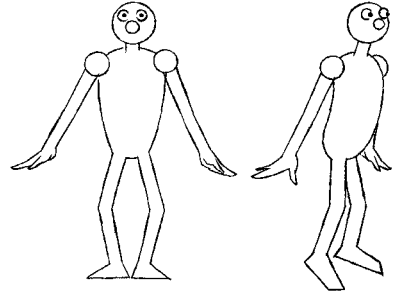

### *back body postures*

These indicate that a character is passively involved or ignoring a message that it is receiving. If your character is leaning backwards, looking up at the ceiling, engaged in some other activity such as cleaning glasses, winding a watch or doodling on a pad you can say that they are passively absorbed or ignoring messages given to them.

These four postures combine together to create four basic modes: *responsive*, *reflective*, *combative* and *fugitive*.

Here are some suggestions for body postures and actions during a range of emotions. Remember, nothing is better than working out these postures by acting the emotions in front of a mirror.

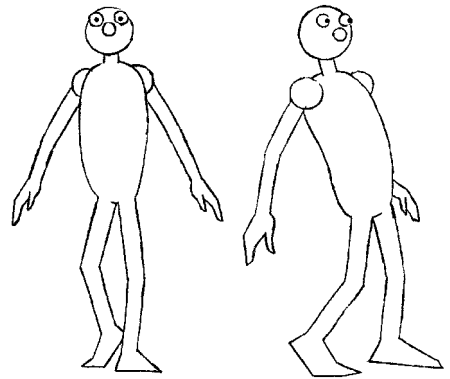

## **responsive**

When a character is reacting *responsively* they will display a combination of open and forward postures. The moods covered by this can be happy, interested, engaged and occupied with something, in love, wanting something, eager and liking something.

A list of different types of responsive body language and the mood that triggers them are now given.

When a character is happy, the body could be angled forward and the head held up. The legs could be apart and the arms and hands open.

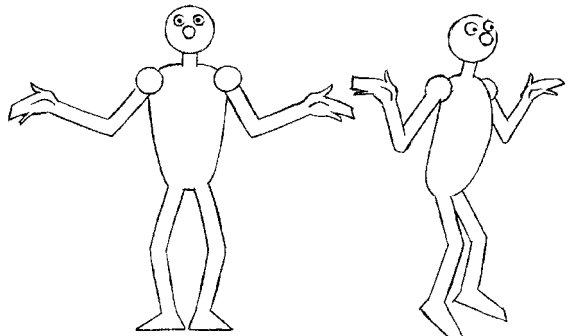

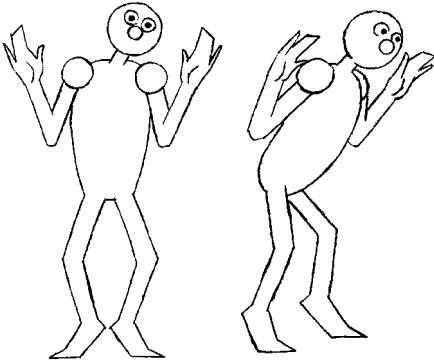

When a character is interested, engaged or occupied with something the body will be held forward and the head even more so. They may be standing on tiptoes, putting the head to one side.

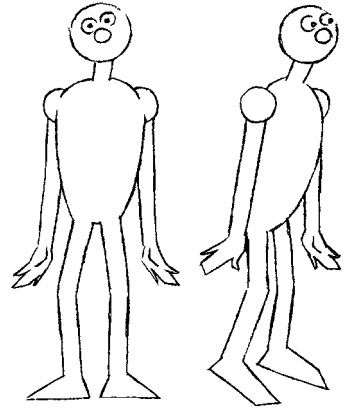

When a character is in love they will have very open body postures and the body will lean towards the object of their affection. The arms will fall loose and be uncrossed, and the palms are turned forwards. The head could be tilted to one side.

When a character is eager, they will also lean forward and be on the edge of their seat (if they are seated). They could grip something like the edge of a table or a pencil. Their head may be jutting forward and their legs kept apart.

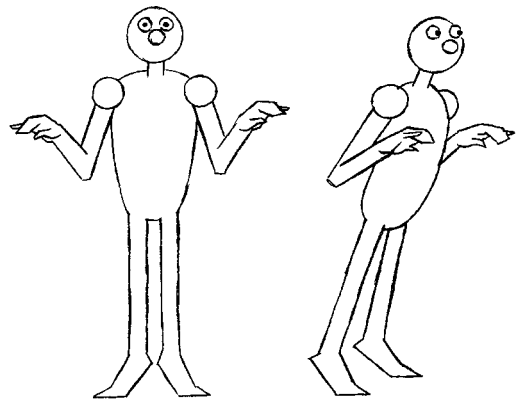

When a character likes something, think of your character doing a down-played version of being in love.

When a character wants something they could put their head on one side, put out their arms with the palms upwards, lean forward and open up the body.

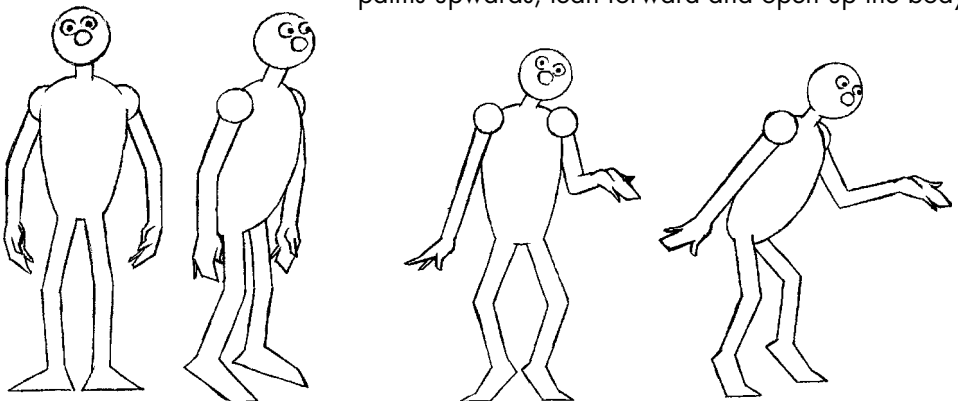

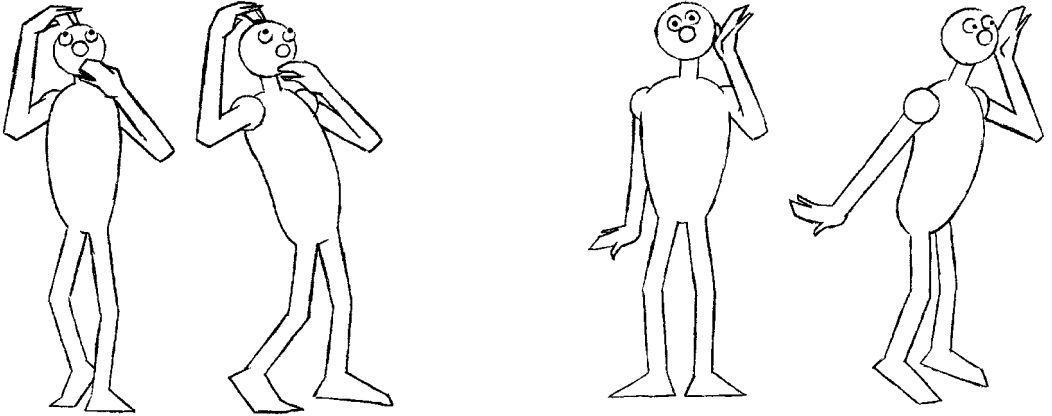

When a character is listening, lean the body forward, tilt the head, raise the arm to cup the ear and have the head nod occasionally.

## reflective

When your character is in a *reflective* mood, they should display open and back postures. This is when your character is considering something, thinking and evaluating or feeling perplexed.

When a character is thinking and evaluating, they may do any of the following. Lean the body back, suck a pencil, stroke the chin or scratch the head. The head position may be angled to one side or looking up to the heavens (often to the right). The legs could be crossed with the ankle on the knee (if sitting).

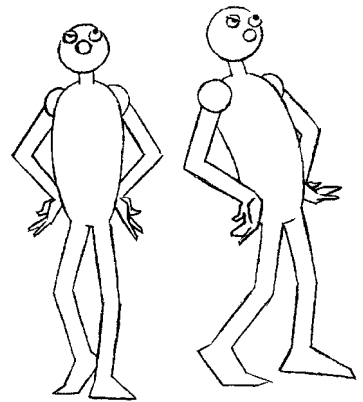

When a character is feeling perplexed, this usually involves a contradiction of body postures. Have the top part of the body open and similar to thinking but have the lower part of the body closed. Have the legs crossed and the feet occasionally moving on tip toes.

A raising of the shoulders and the opening of the arms and palms produces a shrug. This says 'I don't know'.

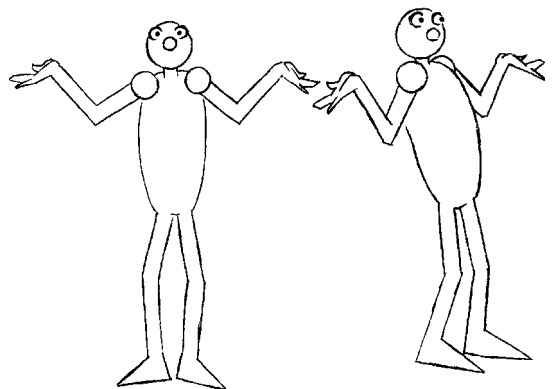

## fugitive

When your character is in a *fugitive* mood they will display closed and back postures. This is when your character is feeling any of the following; rejected, bored, sad or miserable, is in denial, not quite sure of themselves, lying, wanting to get away or is resisting an idea.

Below are a list of different types of fugitive body language and the mood that triggers them.

When a character is feeling rejected or dejected, the body will be leaning back and slumped forward, arms folded, legs crossed with the thigh on the knee (if sitting) and the head down.

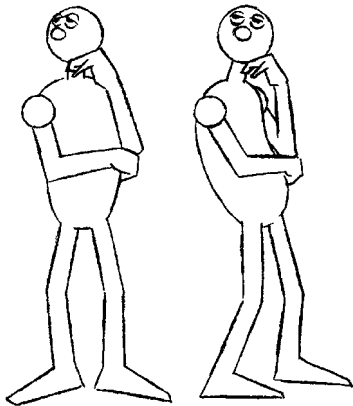
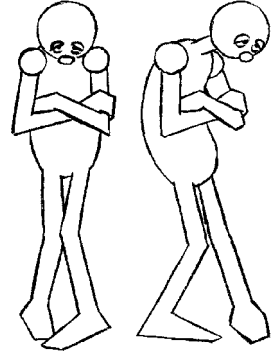

When a character is bored, the body could be slumped or angled back with the head staring into space. The character may be stifling yawns, tapping their feet or fingers, doodling with a pen or looking around for something interesting.

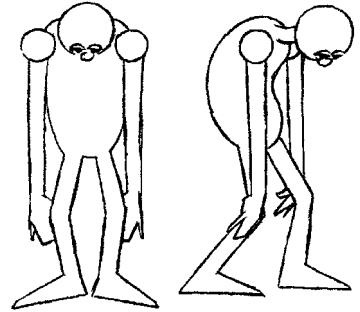

When a character is sad or miserable, the body will be very slumped. The arms will hang lifeless.

The head will be hung low. Everything will seem to be an effort and difficult to do.

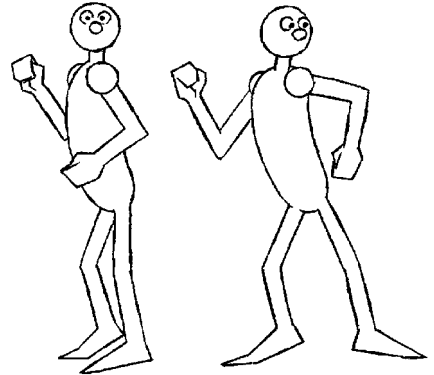

When a character is in denial, angle the body backwards and have the arms sweep across the body as if pushing something away. Have the hands form a fist or a pointing finger. Make the neck tense and hunch the shoulders.

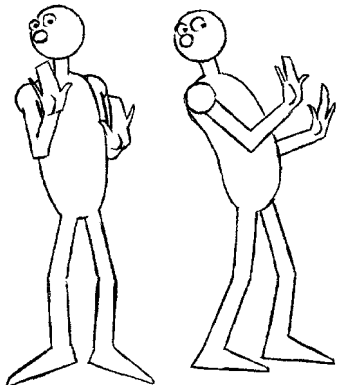

When a character wants to get away, angle the body towards the main route of escape (usually away from the

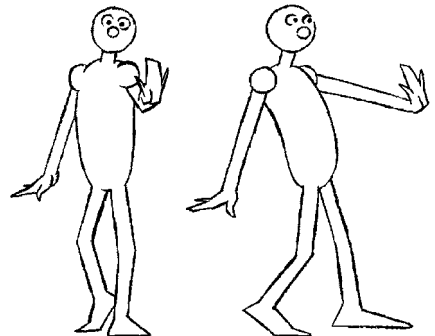

thing that they want to avoid). They will be looking around for a means of escape.

When a character is resisting an idea the body language will be rejecting the idea, the head will be shaking and the head is lowered.

## combative

When your character is in a combative mood they will display closed and forward postures. This is when your character is: angry, wants to put over a point forcefully, is being defiant, wants to have or is having an argument.

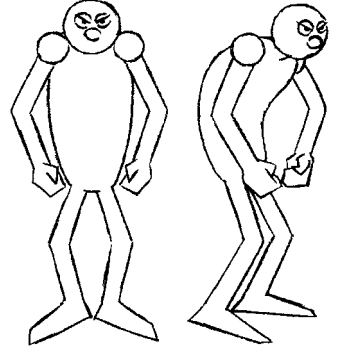

When a character is angry the body will be leant forward. Hunch the shoulders and tense the neck. The arms will hang straight down or will be folded. The hands can form fists or a clenching shape. Tap the toes or stamp the feet.

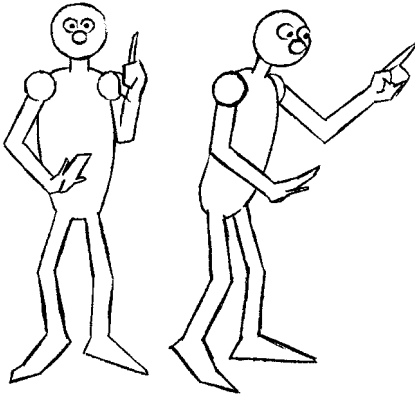

When a character is putting over a point forcefully they will point with the hands and lean forward as if they are putting themselves forward.

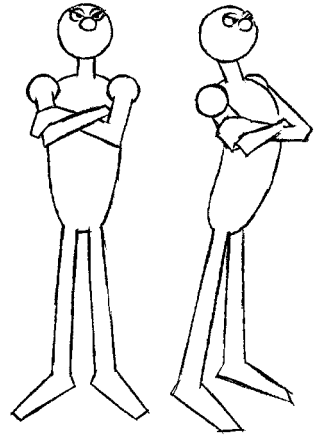

up and cross their arms. The head will be held up high and angled back.

When a character is having an argument they will lean forward, wave their fists, strike things, hunch the shoulders and gesticulate wildly.

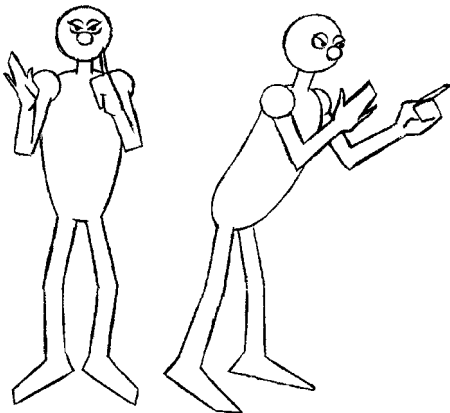

When a character is listening to something that they disagree with they will partly cover the face with the hand. This could have a single upturned finger. The other arm will cross over the body. If seated the legs will be crossed.

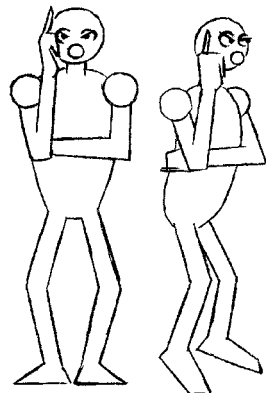



## palm, hand, arm and leg gestures

The hands and arms play a crucial part in our communication with other people. The postures adopted by the legs reinforce these gestures.

### *palm gestures*

The use of the palm can be used to suggest openness and honesty or the lack of it. Honesty and submission are suggested by a character gesticulating with open palms facing upwards or away from the character's body and towards the person they are gesticulating to. You will see this sort of palm signal with the following examples: when people are shrugging, when they are happy, eager, interested or contemplating something.

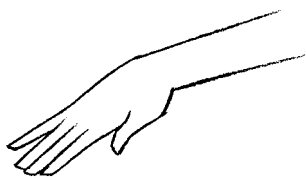
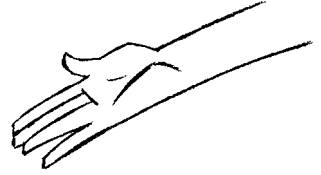

doesn't seem quite right and you tend not to believe the character. This could suggest the character is lying.

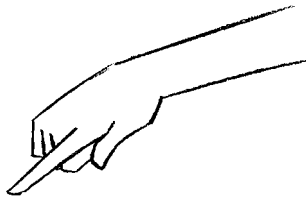

Dishonesty or dominance are suggested by the palms being open but facing downwards or towards the character's body. You will see examples of this when people are being defiant, bored, sad or annoyed. When you see the open body language associated with a 'responsive' body posture but the palms are facing downwards or in towards the character, something doesn't seem quite right and you tend not to believe the character. This could suggest the character is lying.

The closing of the palm suggests anger and aggression or exaggerated dominance. You will see this form of display if somebody is aggressively pointing while talking or chopping the hand across the body. Examples of this type of palm signal will be seen when a character is angry, trying to put a point over, disagreeing with something or being argumentative.

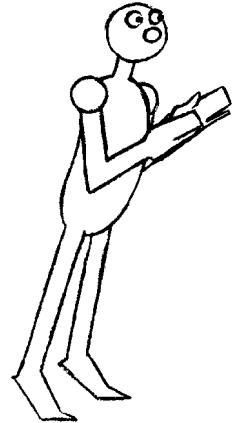

### *hand gestures*

Rubbing the palms together suggests eagerness, excitement and expectation. Rub your hands together before you say something such as 'we're going to make a lot of money on this' and it suggests to an observer that they should be eager and excited too. Rub your hands together as you are saying the same phrase and you will come over as too eager about what is going to happen and will seem to be pulling a fast one over the observer.



Clenching the hands together by interlocking the fingers suggests frustration and that the person

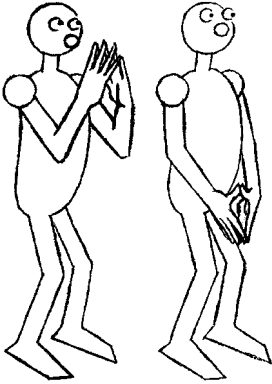

doing this is holding back negative feelings. The hands can be clenched together in front of the body at different positions. If the hands are higher it suggests increased levels of frustration.

When all the thumb and fingertips of each hand are pressed together and the hands are held upright, this gives an impression of superiority. It's usually done when the character is talking, or more accurately pontificating. It's a bit smug and 'know it all'. When somebody is listening attentively



to something the thumbs and fingertips can be pressed together but the hands will be held downward.

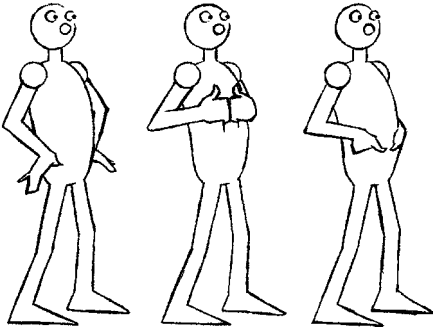

Rubbing the thumb and fingers together suggests money!

Prominent thumbs suggest confidence, dominance or coolness.

Pointing with the thumb is a demonstration of a character pointing at someone or something in a derogatory manner.

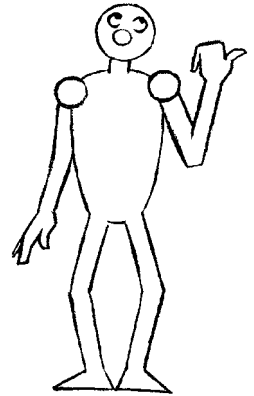

## arm crossing

Hiding behind something is a way of protecting ourselves. If a character crosses their arms in front of them it's as if they are hiding behind their crossed arms. It may be because the character disagrees with something that has been said or it may not be comfortable with the situation it is presented with.

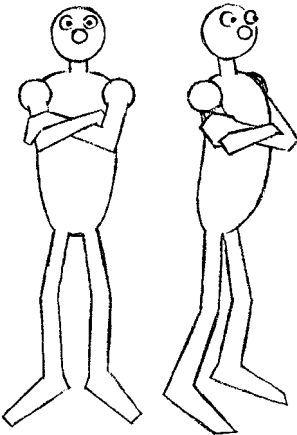

Clenching the fists while crossing the arms gives a hostile signal.

Gripping the arms tightly with the hands while the arms are crossed suggests nervousness and stress.

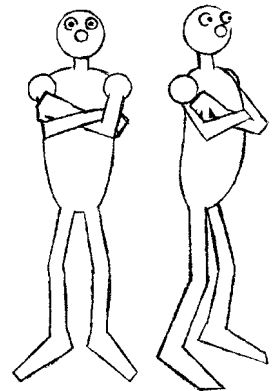

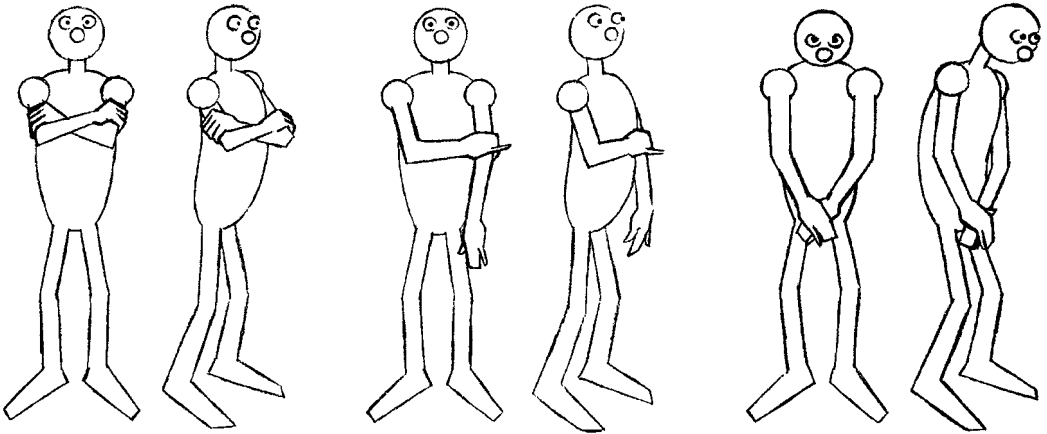

Partially crossing the arms shows a lack of confidence (for example in a situation where the character is with a lot of strange people).

Crossing the arms at the hands, suggests humility.

### *leg crossing*

Leg crossing gives off a similar signal to arm crossing but is far less strong. A basic crossing of the legs can give the impression of defensiveness, but could actually have been adopted by a person trying to make themselves comfortable.

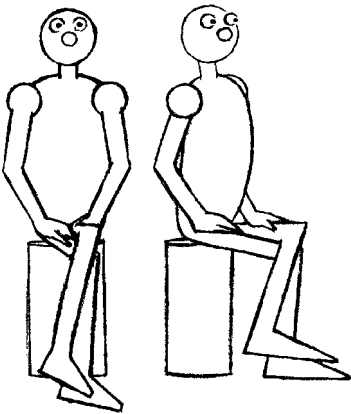

Combine a leg cross with an arm cross and backward body posture and a sour look on the face and you definitely get an impression that a person is showing displeasure.

Crossing the leg with the heel at the knee gives a competitive, aggressive impression.

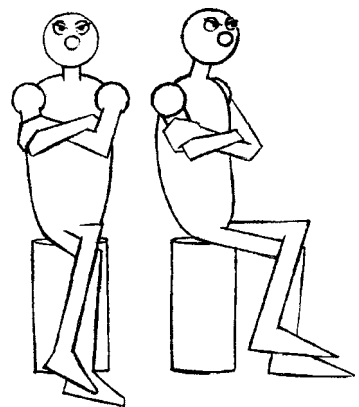

Crossing the legs at the ankles gives a prim and proper look.

Entwining the legs around each other gives an impression of a lack of confidence or nervousness. This can be done both sitting and standing.

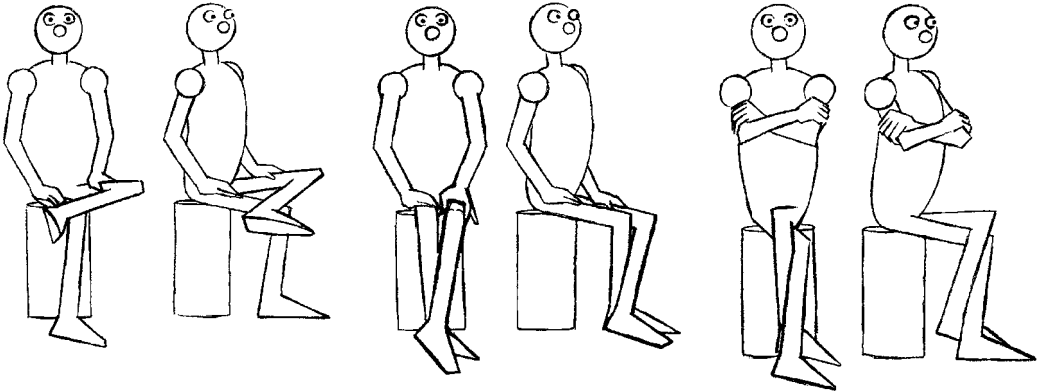

Crossing the legs when standing reinforces the closing off of the body.

Remember. All of these body positions and gestures can be mixed and matched to produce a convincing overall body posture, but nothing beats acting it out in front of a mirror.

## acting out a scene in animation

I tend to think of straight-ahead animation being more like method acting whilst key-to-key or pose-to-pose animation has more in common with theatrical acting.

Straight-ahead animation can throw up some interesting, spontaneous touches but can go out of control, whereas pose-to-pose animation has more control but can sometimes seem wooden and clunky.

In the end you should use a combination of the two.

Work out your character by acting out a scene yourself. It doesn't matter if your acting is not particularly good. Do it in front of a mirror in the privacy of your own home. Think how your character would behave in a given situation. How does your character think? This will govern the way it moves. Note all this down.

When it comes to animating a scene, act it out first then sit down and work out a series of thumbnail sketches. Think of the minimum your character has to do in a scene to make sure an audience is going to understand what is going on. Make sure you have good strong silhouettes. One thing to avoid is something called 'twinning'. This is where the arms (for example) do exactly the same thing at the same time. If the arms are doing a sweeping gesture

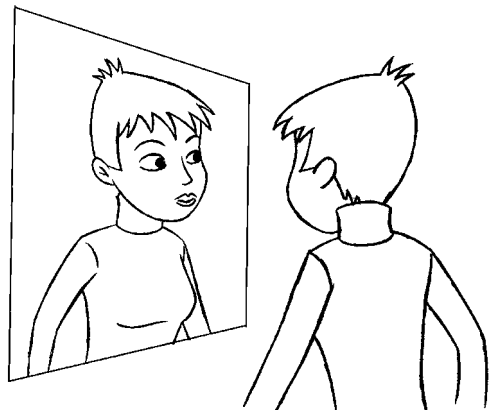
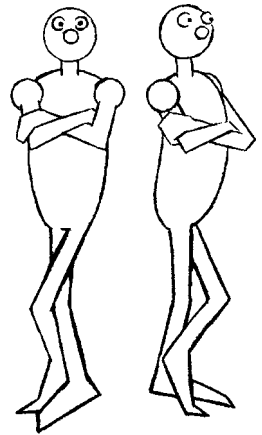

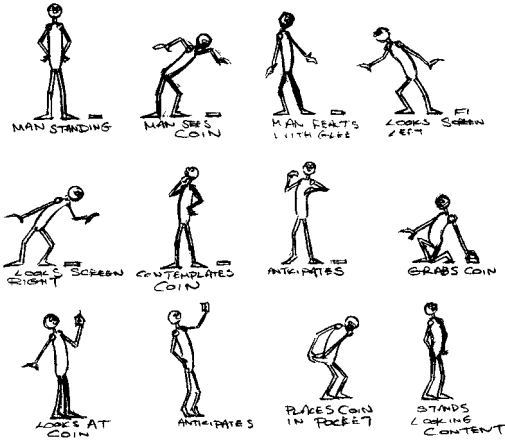

on a photocopier! The idea is to retain the spontaneity of the thumbnails in your animation. Shoot these to the same rough timing as your original pose test with your thumbnails, making sure that nothing is bouncing about

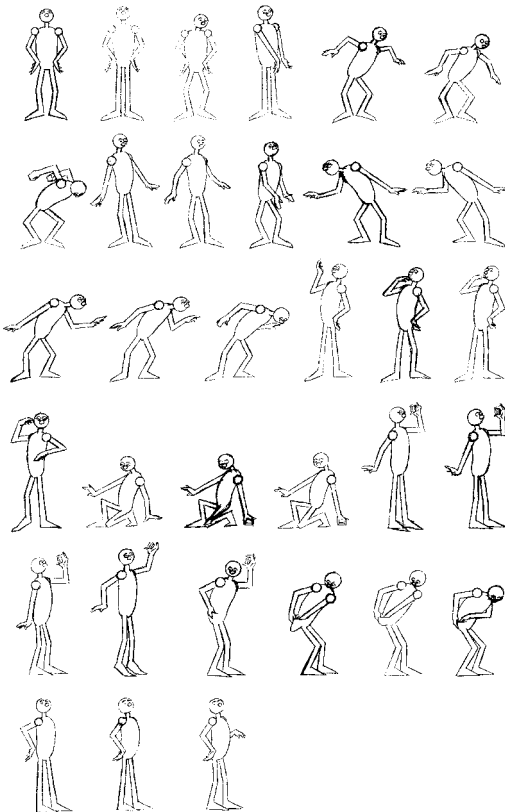

downwards offset one arm slightly from the other (if you act everything out thoroughly you tend to avoid twinning anyway).

When you've completed your thumbnails, shoot them with your line tester and play about with the timing. It doesn't matter if the sizes of the character change, all you are doing is feeling your way through the scene.

You can now re-draw the thumbnail sketches onto full size paper, modifying them as you go along. You could always blow them up

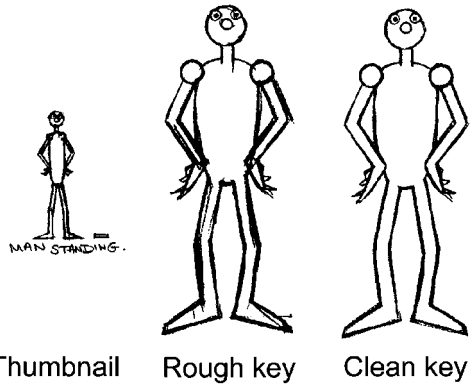

too much, such as feet touching the ground or hands touching the scenery. This test would consist of the major key positions.

After this, sketch in the minor key positions (all the anticipations and overshoots) and some of the major in-between drawings (the breakdowns). Shoot it again. Keep flicking, flipping and rolling all the time.

Generally the way we move in both real life and when acting is to shift from one major pose to another. When we reach each of these poses we still keep moving but make only minor moves. If you want to see a good example of this, just fast forward a feature film and watch how the actor will move quickly from one position to another and then stay put for a short period of time.

Once you've worked out these major poses and the minor key positions (the anticipations out of a position and overshoots into a position) think about things that you can get your character to do while in those poses.

Move your character through a pose in a way to emphasize what the character is doing. If your character is looking off to screen right, move the character into that position and then move them slowly forward a small amount while looking.

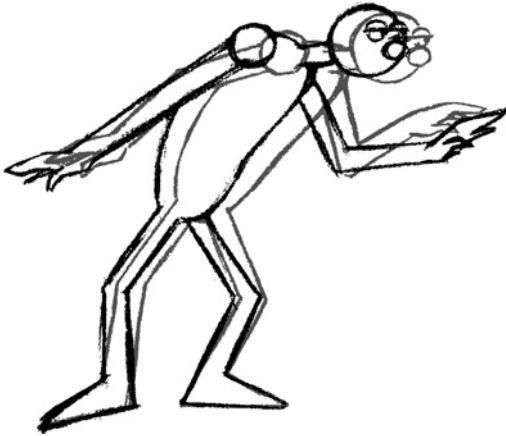

Think about the most extreme position as being one key position and the position that the character moves to as another key position. Then do some timing charts to work out where to place the in-betweens and then complete the in-betweens!

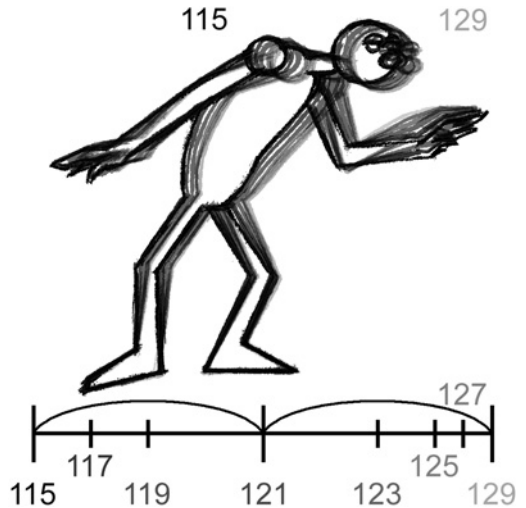

Make sure that when you do the in-betweens different parts of your character move at different rates depending on the item you are animating. For example the drapery will follow through the main movement of the character. One way to do this is to roughly animate one part of the character all the way through the scene. For example, first animate the main movement of the body, then go back and animate a different part of the character (e.g. the drapery). This technique is referred to as building the animation up as layers.



You start with the basics (your characters as simple ball-like shapes), then add the details!

Keep adding to these layers until your animation is finished in rough. Then and only then clean up each animation drawing onto another piece of paper.

## the use of video footage to help your animation

With the advent of small digital video cameras, still digital cameras that take movies and camera mobile phones, it has never been easier to take video footage of the piece of acting that you want to animate as reference. This is something that professional animators have been doing since the 1930s. All of Disney's films had huge amounts of reference footage shot of actors acting out the scenes that were to be animated. It still happens today. One strange thing that I've come across is that some animators think of it as 'cheating'. All I can say to that is that if something improves your animation it's worth doing and spending a few minutes in front of a camera can really help your work.

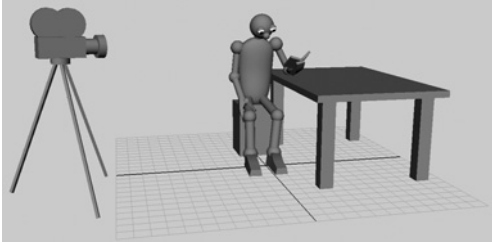

You could film yourself or film somebody else acting out your scene, load it onto your computer and refer to it while animating. I always think it's better to have a go at acting it out yourself, so that you get a better 'feel' of the movement involved. By acting something out, you cause a series of synapses in your brain to form a link that relates to the movement. While you are then animating this movement, your subconscious mind will draw upon this information in order to help you animate it. Sports stars do something similar called 'visualisation'. This is where a sports person will sit down and think about the movement that they are about to perform in great detail (almost frame by frame). They 'visualise' what they are about to do before they do it. This is to link up a chain of synapses in their brain, so that when they are performing that triple axial summersault or that impossibly high jump over a bar their subconscious mind will not have to be thinking about this movement while they are doing it. Because of the link of synapses in their brain it's as if they have done the movement already.

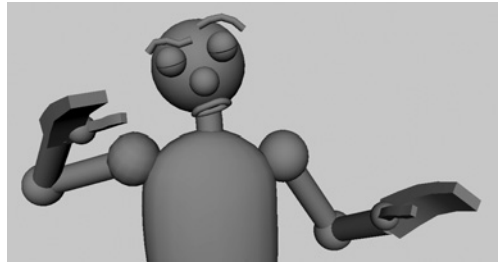

So, when it comes to animating a scene. Write down a basic list of what's going to happen. (For example, man sat reading book, man glances up, man does a double take and looks up in a more exaggerated way). Then act it out yourself a few times until you think you've got it how it needs to be. Then act it out in front of somebody else. Get their comments on what you've done. Do they understand it? Does the movement fit in with what they understand as the personality of the character? When you've taken all of this onboard and re-acted it a few times so that it feels natural, get somebody to film you with a digital camera.



Film yourself a few times, using different timing and mannerisms. One thing you will find is that you will start putting things in that you never would have thought of if you had

just started animating it straight onto the computer. You may also need to shoot it a few times. For example, with the first video that I shot, I felt that the first look off screen was too subtle (have a look at 'vid-ref01' in the movies folder of chapter009 on the CD-ROM). So I shot it again with a bigger 'look' off screen at the start ('vid-ref02').

With the movie(s) downloaded from the camera onto your computer, watch them a few times. Try to remember how it 'felt' to do the movement. If you did several 'takes', watch them all and take the best bits from each movie and apply it to your piece of animation. The most important thing is to not slavishly copy the footage. Take the essence of it. You may

have to change the timing (you will usually have to animate things a bit slower than real life). You may also need to exaggerate each of the poses as well as the anticipation, the movement itself and overshoot and overlapping action.

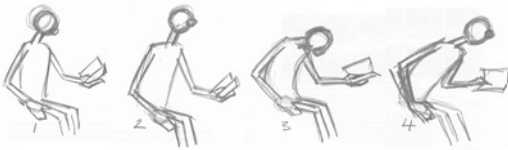

Once you have watched the footage over and over again (almost until you are sick of it) do a series of thumbnail sketches for you to stick on the wall to refer to. This will also make it a lot clearer in your head what you will need to do once you are animating.

Finally, after all of this research get on with animating the piece, constantly referring to the video footage, thumbnails and your own experience of doing the move.

By the way, never think that doing this is a replacement for having a mirror on your desk and using that to help with facial expressions (as well as using it as a reflection of your screen to make sure that your key positions are 'balanced').



I found in the example that I did, that I added a small glance of the eyes before I did the first 'look' off screen. I also added a bit of breathing and the eyes reading the book at the start of the screen. I speeded up the anticipation into the double take and added a bit of breathing to the hold at the end to make it seem less static.

Take a look at 'reading-book' in the movies folder of chapter009 of the CD-ROM.

## the seven questions of character

This is where you ask yourself, seven basic questions about the personality of your character. From the answers you can build a solid, defined character, that everybody should understand.

This is a very useful thing to do when working out what your character is like. It establishes where they have come from, where they are going and how they would react in a given situation. It is also something that should be done very thoroughly on a movie where several



animators may be animating the same character. Often I've seen the same character animated by several animators in several different ways, leading to a degree of confusion on the part of the audience!

So before you do anything (storyboarding, or even scriptwriting, let alone animating) ask yourself the following seven questions of your character:

WHO AM I? (WHO IS YOUR CHARACTER: NAME, AGE, TEMPERMENT, ETC.).

WHERE AM I? (WHERE IS YOUR CHARACTER: IN A BED ROOM, UP A TREE, ETC.).

WHEN AM I? (PRESENT DAY, SEVENTEENTH CENTURY, IN THE FUTURE, ETC.).

WHAT DO I WANT? (WHAT DOES YOUR CHARACTER WANT: MONEY, POWER, A SIMPLE LIFE, ETC.).

WHY DO I WANT IT? (WHY DOES YOUR CHARACTER WANT IT?).

HOW WILL I GET IT? (HOW WILL YOUR CHARACTER GET IT?).

WHAT IS STOPPING YOU GETTING IT? (WHAT IS STOPPING YOUR CHARACTER GETTING IT?).

These are standard questions that any actor would ask himself or herself when establishing a character for a play or film. You don't have to slavishly stick to these questions but they do act as a firm foundation in enabling you to get your character clear in your head and being able to explain your character to other people (producers, directors, clients, an audience or other animators).

You will find a .pdf form of these seven questions that you can print out and write on in the chapter009 folder of the CD-ROM. When you have filled it out, stick it up on the wall above your desk and keep referring to it!

## **the different sorts of animation acting**

Depending on the budget, time scale and type of production, most acting in animated films tends to fall into the following categories.

### *animated radio*

Also known as limited animation, this form of animation is a series of pictures that illustrate the script.

This is probably the simplest form of animated acting. It is frequently used in low-budget TV series. The characters move as little as possible and tend to be flatter in design, to save time

and money. When using limited animation your script needs to be as good as possible because you can't use the animation to distract from weaknesses or holes in the plot.

Animators working on these productions have to think far more about the drawings they do and they have to be very good drafts-persons. The audience is relying on fewer drawings to convey the story.

### *pose-to-pose animation acting*

Generally this is the type of acting employed in Hollywood animated shorts. The best exponents of this are Tex Avery (Droopy, Screwly Squirrel) and Chuck Jones (Wile E. Coyote, Daffy Duck, Bugs Bunny).

Pose-to-pose animation involves drawing the best poses which emphasize the central themes to the story line and animating between each as quickly as possible. When your character is in these strong poses you then give them something to do. This type of animation makes a virtue out of the strong poses it uses.

It's the kind of animation that expresses a point effectively but won't get in the way of your ideas or gags. It suits fast aggressive, violent humour.

This kind of animation could not sustain a feature film – you'd be worn out after 70 minutes. Having said this, it's fast and furious and if done well, very funny.

### *full animation acting*

This is the kind of animation used in feature films and is probably the hardest to do. It's animation that requires light and shade. You have to spend time with the characters in order to know them well enough to care about them for 70 minutes. In earlier animated feature films the heroes were usually as dull as ditch water but the villains (and the comic relief characters) were really exciting. Nowadays, scriptwriters tend to emphasize the comedy (and the flaws) of the heroes in animated feature films. It's because their characters are flawed that they are interesting.

Full animation will involve using similar techniques to pose-to-pose animation but the poses won't be as obvious. The movement will be more fluid and continuous. Although an animator will draw the key poses and in-between them (or set keys on his/her computer model in 3D) the animation will not look as if it's moving from one deliberate pose to another. It is a type of animation that has the freedom and fluidity of straight-ahead animation and the discipline of pose-to-pose.

One way to help with full animation is to leap about in front of a mirror and live and breathe the character you are animating. Draw sketches of the movements and poses and shoot them in sequence as a 'pose test'. From here draw the sketches as the key drawings and animate straight ahead between each drawing aiming roughly at the next key position (use the timing you worked out in the pose test). If, when you reach the next key, your straight ahead drawings have changed from the original key position, go with it. Continue going through

the sequence in this way. Animate straight ahead but use the key drawings as a guide to where and when you will end up during the animation.

One of the main processes animation studios use to make its characters more real and believable is for an established actor to provide the voice. They will also often film an actor performing most of the movements, sometimes, the same actor who provides the voice.

The best characters in most animated feature films are often the villains. The movement and acting tends to be far bigger and more exaggerated. Because of this, they are frequently voiced by stars who can throw themselves into the roles with zeal. Sometimes the heroes can seem rather dull in comparison. These characters can be more difficult to animate. The acting required is much more subtle. The best way to make their characters more interesting is to emphasize their humorous side.

Fully animated characters should be fairly simple in their design and not have lots of complicated bits and bobs attached to them. The more complicated the character the more awkward it is to animate and the more awkward it is for an audience to watch.

When using full animation some actions are more difficult to animate than others. The subtle movements made when somebody is sitting down and doing nothing other than thinking can make this difficult to animate well. Animating a swash-buckling sword fight is much easier to do because of the complexity and speed of the action. There's only one thought going through the head of a sword fighter and that is 'how do I swing at my opponent again?' When animating somebody falling in love, there are hundreds of thoughts going through their head. To convey these emotions and thoughts you've got to animate them all bubbling to the surface. It's much easier to act out a sword fight in front of your full-length mirror than it is to convincingly portray a believable love scene. This is because complex action is very different to complex acting.

Full animation also demands a good use of timing and sense of design for the overall screen image. For this kind of film making you not only have to know when to slow your animation down and when to speed it up, you've also got to know when to hold back with your background animation and when to exaggerate. It's all very well having the most brilliant animation in the background but if it distracts the eye from the main purpose of the scene it's worse than useless.

### *mime*

It is worth looking at and studying mime artists. If they are performing well, they have amazing control of their bodies and are able to convey emotions with the smallest gesture. The whole body can portray emotion. For example, the head hung low, the shoulders dropped, the body bent over and the legs dragging the feet suggests an air of depression. The folding



over of the arms and legs suggests somebody that is lying or feeling uncomfortable. Somebody who is happy will walk with a spring in their step, their movements will be quicker and quirkier.

Mime is used in a lot of European animated films. If you make a mute film it can be viewed by a larger global audience. This is why they are so popular around the world.

## analysis of a character

The basic idea is to live and breathe your character – act out everything your character has to do and present it to an audience so they understand what makes that character tick.

Actors have drawn inspiration from animation, as well as the other way round. Laurence Olivier based his portrayal of Richard the Third, in the film of the same name, on the wolf in Disney's *Three Little Pigs*.

One of the best things to do before you start animating is to write down a list of the main character traits of the character you are about to animate. On a professional animation project, your director has, hopefully, already done this and will be able to brief you before you start animating. When you're working on your own project you'll have to do it for yourself!

MY CHARACTER IS:  
 GREEDY.  
 A COWARD.  
 THE KIND OF PERSON  
 DISASTERS HAPPEN TO.  
 SELFISH.  
 (MY GOD! IT'S ME!)

Make sure you also have a good collection of model sheets to work from.

## exercises

### *animation of acting in 2D*

The exercise below is of a character spotting a coin on the floor, looking around and quietly pocketing the money. As with all the exercises this is a guide which can be followed. Other ideas include somebody picking an apple out of a tree, a book off a shelf, a cake off a plate on a table or picking somebody's pocket. The aim is to have a character see something, covet it and sneakily take it.

Have a character standing in medium shot, slightly to one side of the screen. To the character's side on the ground is a coin. The character is going to see the coin, sneakily look from side-to-side, pick up the coin, look at it and then pocket it. Act it out in front of a mirror and draw a series of thumbnail pose sketches (or have a look at the bottom illustration on p. 196) of the major key positions. Shoot the thumbnail sketches as a basic linetest. Take a look at *coin\_thumbs.avi* in *animations009*, chapter009 of the CD-ROM.

Once you're happy with the timing of the thumbnails, draw them full size and think about the minor key positions. These are the smaller movements your character makes when in a pose. They are also the anticipatory movements out of one position and the overshoot positions into another. Remember to slug out these actions in the action column on your x-sheet.

Between the equivalent of the first thumbnail sketch (character standing) and second thumbnail sketch (character looking at coin), have the character straighten up and then glance down at the coin, do a double-take and then do a big look at the coin. Key 1 (frame 1) is basically the same as the first thumbnail sketch; the character is standing centre screen. Key 2 (frame 11) is at the highest point of the straightening up. Key 3 (frame 33) is at the point where the character finishes glancing at the coin. Key 4 (frame 37) is at the anticipation of the second look. Key 5 (Frame 45) is the big look at the coin and is the equivalent of the second thumbnail sketch.

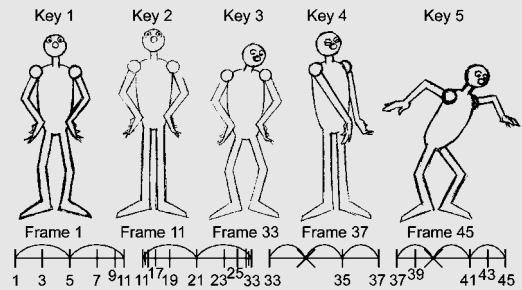

Between the equivalent of the second thumbnail sketch (key 5, frame 45) and the third (character standing back and looking at the coin with glee (key 8, frame 69)), have the character looking at the coin as it moves closer to the coin and do an anticipation into the look of glee. Key 6 (frame 57) is at the end of the movement forward as the character is looking at the coin. Key 7 (frame 63) is the anticipation position, which then leads the character to move into the look of glee (key 8, frame 69).

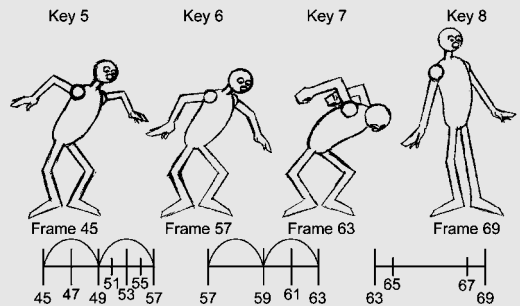

Between the equivalent of the third thumbnail sketch (key 8, frame 69) and the fourth (character looking screen left (key 11, frame 93)), have the character move forward as it is looking with glee and then do an anticipatory move into the look screen left. Key 9 (frame 81) is at the last position where the character has moved forward. Key 10 (frame 85) is an anticipation position, which then leads the character to the look screen left (key 11, frame 93).

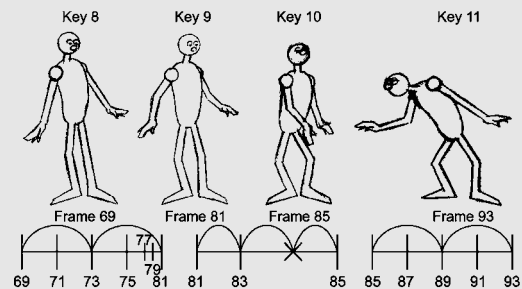

Between the equivalent of the fourth thumbnail sketch (key 11, frame 93) and the fifth (character looking screen right (key 13, frame 115)), have the character lean forward in the direction that it is looking. Then have it move quickly into the look screen right. Key 12 (frame 107) is the last position where the character has leant forward, before it moves to key 13 (frame 115) where it is looking screen right.

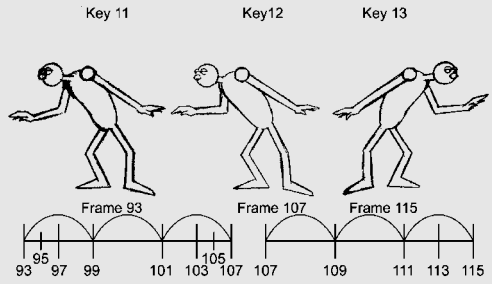

Between the equivalent of the fifth thumbnail sketch (key 13, frame 115) and the sixth (character pondering coin (key 17, frame 145)), have the character move in the direction of the look off screen right, then anticipate the movement up into the pondering position, overshoot and then go back down into the pondering position. Key 14 (frame 129) is the last position of the move towards the look screen right. Key 15 (frame 133) is the anticipation position. Key 16 (frame 141) is the overshoot position, which then leads back down to key 17 (frame 145), where our hero is pondering the coin.

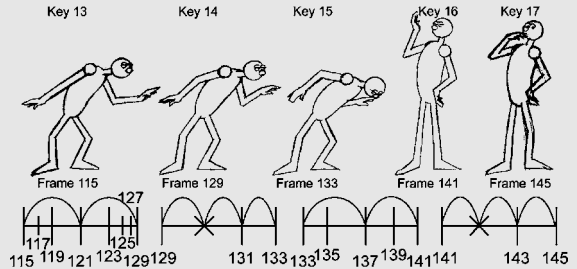

Between the equivalent of the sixth thumbnail sketch (key 17, frame 145) and the seventh (character anticipating grabbing the coin (key 19, frame 163)), have the character straighten up slightly whilst pondering the coin. Key 17 (frame 145) is the first position of the character pondering the coin. Key 18 (frame 159) is the last position of the character pondering the coin, having straightened up slightly. Key 19 (frame 163).

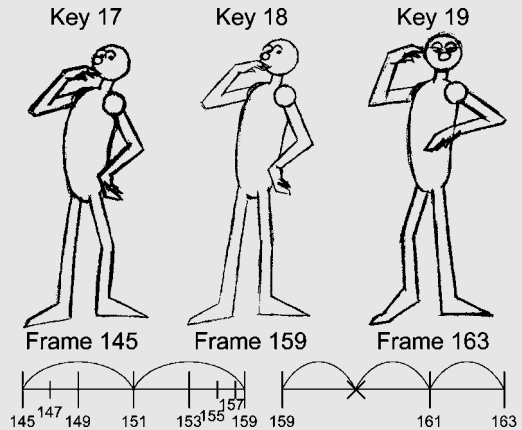

Between the equivalent of the seventh thumbnail sketch (key 19, frame 163) and the eighth (key 21, frame 173), have the character overshoot the coin-grabbing position with the fingers outstretched and then bring the character up slightly as it grabs the coin. Key 20 (frame 169) is the overshoot position. Key 21 (frame 173) is the coin-grabbing position.

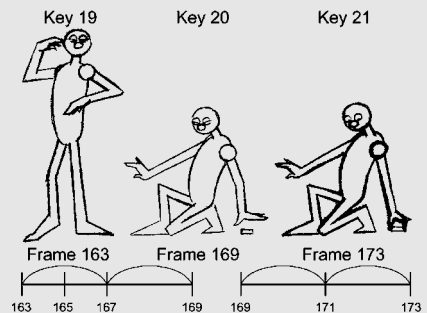

Between the equivalent of the eighth thumbnail sketch (key 21, frame 173) and the ninth (character holding up coin and looking at it (key 24, frame 187)). Have the character, while it is still grabbing the coin, move down slightly and then move up to and overshoot the position where it is looking at the coin. Key 22 (frame 177) is where the character has moved down a little. Key 23 (frame 183) is the overshoot position. Key 24 (frame 187) is the point at where the character looks at the coin.

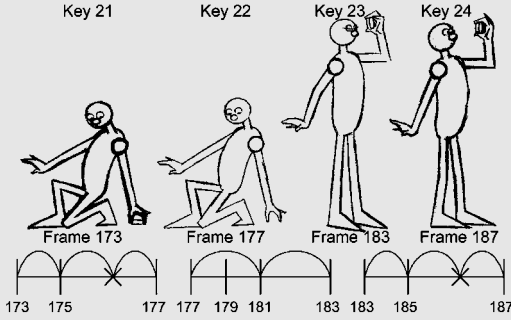

Between the equivalent of the ninth thumbnail sketch (key 24, frame 187

and the tenth (key 26, frame 205)) have the character move slightly as it looks at the coin and then lift the arm up as an anticipation position. Key 25 (frame 201) is where it is still looking at the coin but has moved its arm outwards a bit. Key 6 (frame 205) is the anticipation position of the arm going up before it is plunged into the pocket.

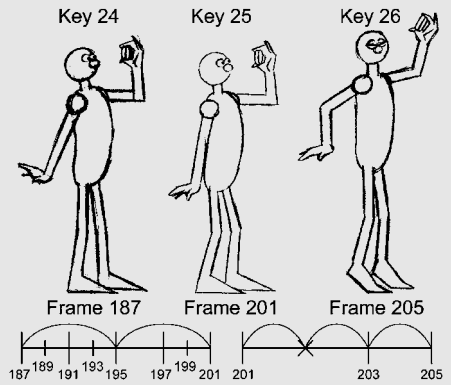

Between the equivalent of the tenth thumbnail position (key 26, frame 205) and the eleventh (character with hand plunged in pocket (key 28, frame 215)). Have the character grab the pocket at key 27 (frame 211).

Between the equivalent of the eleventh thumbnail position (key 28, frame 215) and the twelfth (character standing looking innocent

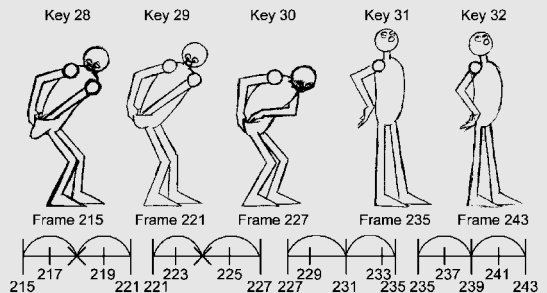
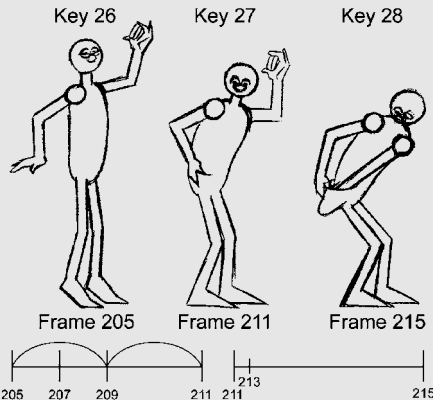

(key 32, frame 243)), have the character pull its hand out of the pocket and put its hand on its hip. In key 29 (frame 221), the character still has its hand in the pocket. Key 30 (frame 227) anticipates the character popping up. Key 31 (frame 235) is where the character overshoots into the hand on the hip pose which is key 32, frame 243).

At the end the character keeps still but brings up its arm.

Take a look at *coin\_2D.avi* in chapter009 of the CD-ROM.

### *animation of acting in 3D*

Load your character onto your program and at the first frame set the character up so it is stood exactly like frame 1 of your drawn animation (the first illustration on p. 204). Make the length of the scene the same length as your drawn animation (in this case 252 frames long).

Create some ground for the character to stand on either by creating a grid or a very short, wide and deep box and place it under the character's feet.

Make a coin by creating a cylinder and give it a radius of 0.5 and a height of 0.2 (5 and 2 in 3DS Max). Place the coin on the ground to the right of the character, about 5 units from the centre.

Create a second coin and parent it (attach it) to the hand that will pick the coin up. Make the coin in the hand invisible until the hand grasps the coin on the ground then make it visible. At this point make the coin on the ground invisible for the rest of the scene. (It's just like the ball we picked up in Chapter 3.)

Go through the sequence copying each of your drawn animation key positions onto your 3D-program or copy the bottom illustration on p. 196 and all the illustrations in the previous 2D exercise section.

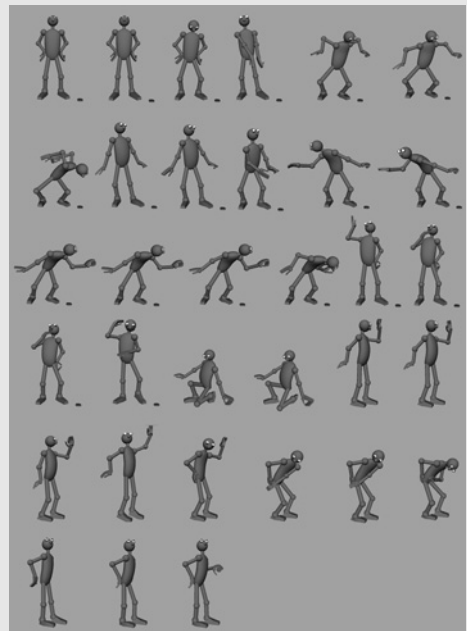
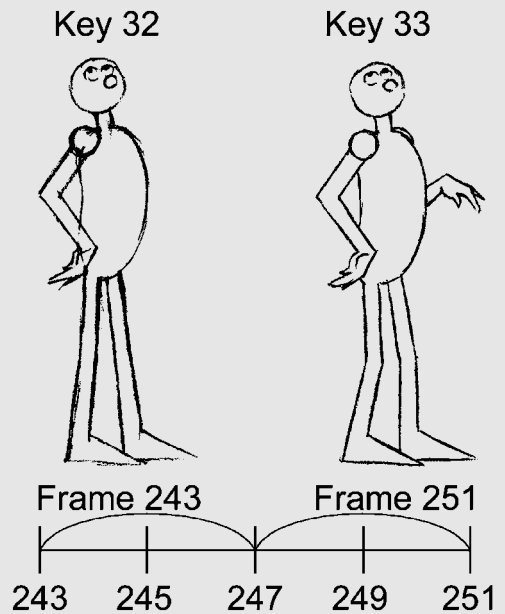



Take a look at `coin_keys_3D.avi` in chapter009 of the CD-ROM. The movement during the sequence is close to being as it should. However there are some important faults. The movement/dynamics throughout the scene are slightly too even. The character seems to sway around at the points where it should be making a small amount of movement (e.g. where the character looks off screen and the point where he looks at the coin). The legs also act very strangely. Go through the animated sequence inserting further keys at the positions of the breakdowns (the major in-betweens) between the keys you have already set.

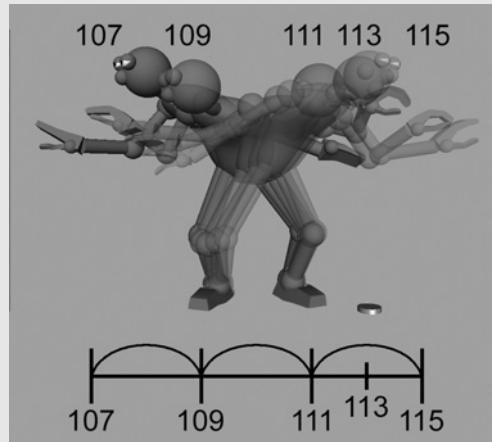

At the points in the animation where the character should only move slightly, flatten out the animation curves to make them linear. This will take out the swaying motion.

Finally when this is working, go back and animate the hands and fingers, the eye blinks and the swivelling of the feet on the ground. It's often best to animate the hands straight ahead.

You could even have a go at making a pocket out of a sphere. Shape it as a cup shape and make it appear as the character opens the pocket. Scale it as the coin is thrust into it and make it disappear as the character's hand lets go of it.

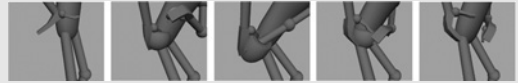

Take a look at `coin_3D.avi` in animation009, chapter009 of the CD-ROM.

## building a more sophisticated character

Because modelling and rigging a more sophisticated character is quite different in each of the four animation packages covered by this book, I've kept everything to its fundamentals. You should be consulting the manual that came with your software, whilst constructing your character.

The first thing to do when building an animated character is to think about what motivates the character. So do the 'Seven Questions of Character'. Then work out which Laban 'efforts' suit the character and list those as well. Then work out the practicalities. Think about what your character will need to do during the piece of animation that you are going to create and make sure the character is going to be able to do them. For example, if your character needs to reach

up to a high shelf, will their arms raise above it's head, are the arms long enough to reach and will the hands be able to pick up the thing they are trying to reach? Make lots of lists.

Next, put together a 'mood board'. A mood board can be the cork board above your desk or a bit of cardboard that you have stuck anything on it that will inspire you with the creation of you character. It could consist of illustrations from magazines, postcards, photocopies, print outs from websites or fast food paper bags. Any thing! And don't just think about the shape of your character. Think about the colours, textures and feel of your character and the movie they are going to be in. It's always better to have all this reference stuff 'out in the open' where you can see it all the time. Rather than keeping it all on a computer where you will have to go to a certain amount of trouble to open up a file and you can't see everything at once.



Then, draw, draw, draw. Fill up sketchbooks. Draw on paper napkins at restaurants. Have a sketchpad with you when you go to bed, so that inspiration does strike, you can jot it down. Think about drawing this character in every shape, form, mood and position you can think of. Live and breathe the character. Do a drawing as if your character is drawing it.

The clearer idea you have of what your character looks like and how they are made up mentally and emotionally the better your model of that character will be. Don't worry if a lot of your drawings are no good. The sooner you get the bad drawings out of the way the sooner the good ones will turn up.

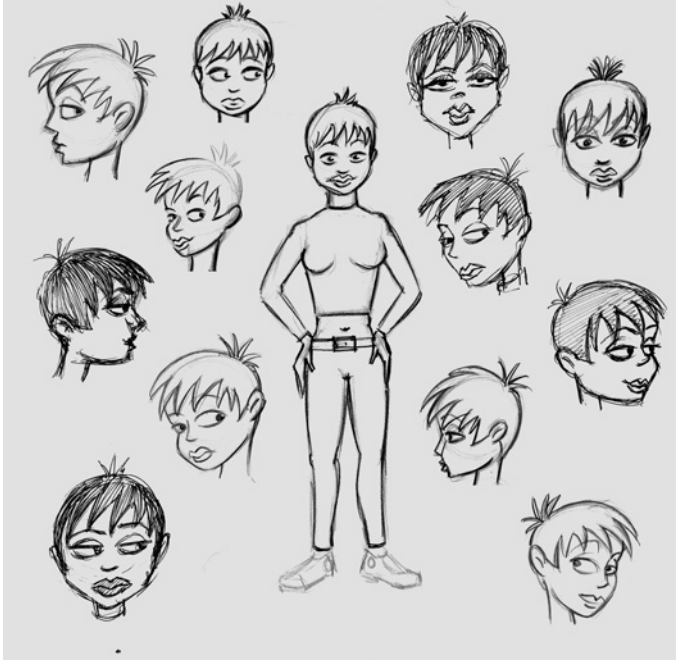

Have a go at making your character in modelling clay. A 3D model will give a better idea of what kind of silhouettes it will produce and also helps you iron out any awkward shapes. Rounded shapes seem to move better through space than angular shapes and tall thin characters tend to produce better silhouettes than short fat ones. It has to be remembered that most of the best 3D-animated characters that you have seen in the movies were sculpted in clay first and then scanned into the computer. They would then be 'cleaned up' and tweaked to make them look better.

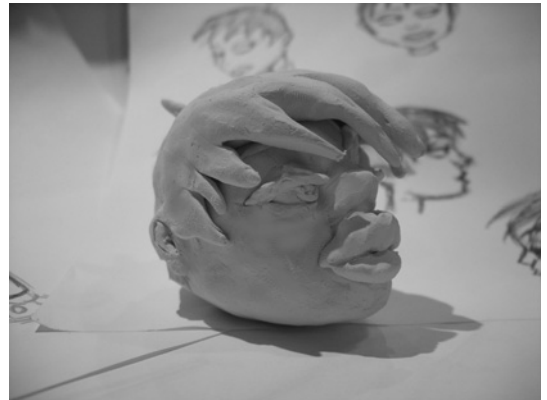

Finally draw up a plan and elevation diagram of your character. That's a straight on front and straight on side view of them. We are going to scan this into the computer as a .jpeg and set it up in your 3D environment. It will then be used as reference as you model.

After all of this, you can finally switch on your computer. When building your character think how you can divide it up into bits. It's always going to be a lot easier to work on small bits one

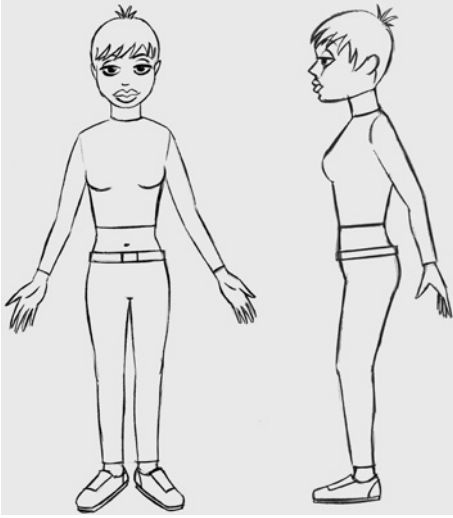

at a time rather than a whole character. So the head can be one part of the model, the torso another, the arms another and so on. I always think of this way of construction as being a bit like one of those Kinder Egg toys. The little characters that you get in a plastic egg inside the chocolate egg. They tend to have one piece of coloured plastic for the head, another piece for the hair, etc.

The reason why this makes life so much easier is that you can apply a texture or colour to each individual component, rather than having to paint a huge complicated texture map that you have to apply to the whole character. When this method is done well it can look fantastic. When it is done badly it can make your character look like a badly wrapped Christmas present.

Scan in your plan and elevation drawings. Import them into your program and arrange them in the centre of the screen, so that they cross over each other in the middle.

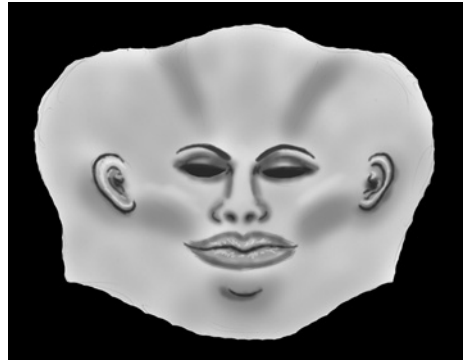
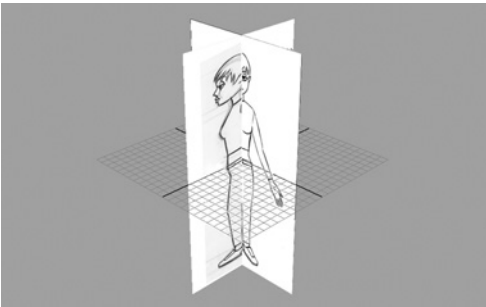

When it comes to building your character it's probably best to start with the head. It's the part that will require the most time and patience to get right and it's also the most important part for your audience as well. Although the body is the most important part for putting over the general mood of the character, the face tends to be the part we are all drawn to look at in order to get an idea of what is going through somebody's head. So it's a good idea to get it right. The minimum we need to get over all the emotions that are possible is two eyes (with eyelids), two eyebrows and a mouth. Of course it's nice to have a nose that can be moved a bit, cheeks that can help emphasise expressions, forehead that will produce good frown lines and a moving jaw to help with bigger expressions. I would always keep every thing as simple as possible to make life easier for you and your audience. The more detail there is, the more work there is for you when modelling and animating and the more chance that your audience will get confused by the complexity.

To create the head you have two options. Use a sphere and pull and push points around until you have a shape that resembles your characters head or use 'Nurbs Patch' modelling.

'Nurbs Patch' modelling is where you build up the shape of the characters head one line at a time. Starting with a sphere tends to be better for more simple cartoon type characters, 'Nurbs Patch' modelling is better for more realistic characters. It means you can take into account the way in which a real face is built up with the muscles under the skin.

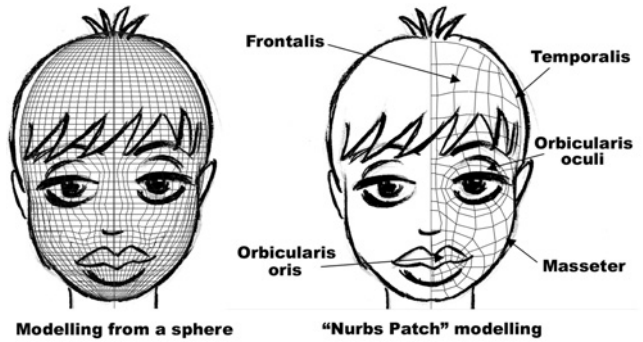

You will need to push a certain amount of the mesh inside the head to create a mouth. With in this you could put in a separate tongue and teeth and link them to the head (make them children of the head).

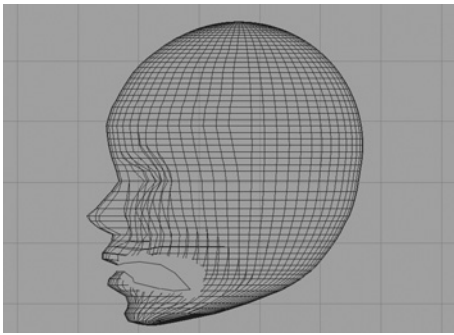

Once the head is done, think about whether you want to put on the eyebrows as part of the mesh and painted on the texture map, that you apply to the head. Or whether they are separate shapes you have created and link them to the head. The eyes can be created simply as white spheres with a squashed black sphere attached to it for a pupil. Or if you want something more realistic get a sphere and squash one side of it flat. On this place a disk that is coloured or has a texture map on it which will be the iris. On top of

this place a small black disk that will be the pupil and finally on this place another smaller sphere that is squashed flat at the side for the lens. Have it so that this sphere is rendered see through. You can control the size of the pupil by scaling the back disk bigger and smaller. Make all the parts children of the larger white sphere and in turn make this a child of the head.

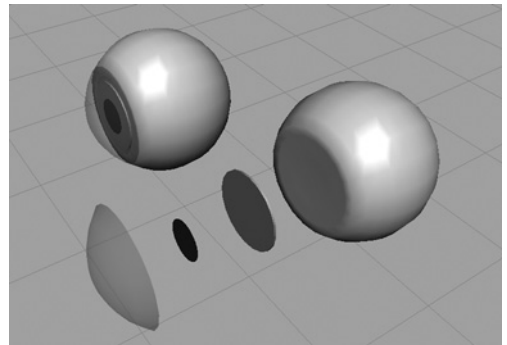

When it comes to the body, try to think where the body can be divided up into bits. The arms can be separate from the torso and if your character is wearing a t-shirt the seam at the sleeve could be where they join. The top could be sleeveless and the arms join at the shoulders. If the shirt has long sleeves, don't go to the trouble of making an arm to go inside. Just make a sleeved arm and then build a separate hand to pop in the bottom of the sleeve.

The more you plan these things out at the start. The easier it will be when it comes to modelling. Model the skirts, trousers or shorts separately from the top and model the legs (however much you are showing of them), separately as well.

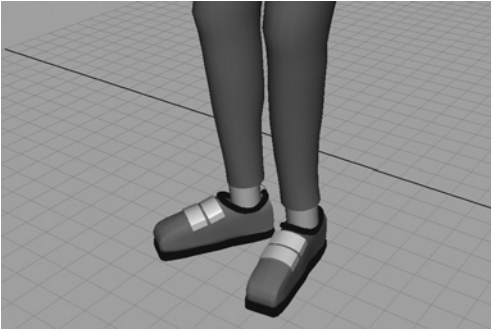

When it comes to the arms and legs, great care has to be taken when sorting out the elbows and knees. It's at this point that the limb will bend and in order to avoid that 'bent hoes pipe' look, you will have to make sure that there is plenty of mesh at these joints and that you have weighted all the points correctly. This will happen when you rig the model.

If your characters' feet are in shoes, just model a shoe and stick it on the ankle.

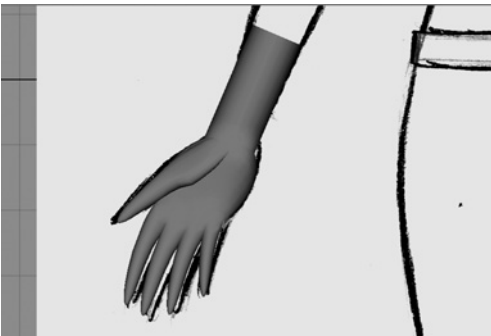

When it comes to the hands, as always, simplicity is the key. You may have noticed that in a lot of drawn cartoons the characters often only have three fingers and a thumb. The main reason for this is that it's less work to draw three fingers than four and also you can do anything you want with only three fingers (two fingers look weird). In the 3D world you can make a character with four fingers (and a realistic three-fingered human character would look rather odd) but it will be more work to model and animate. In my example I've kept

the fingers separate from the palm of the hand to make life easier with modelling and weighting. Everything was made from a sphere.

When it comes to rigging your character, again keep it as simple as possible. You could copy the basic rig I did for my man character. All I would change is to make the joint for the ankle a bit higher (because this joint is not flat on the ground in a human being). I would also add some handles to each of the backbones, the neck joints, the head joint, the eyelids and to the shoulder joints, just to make them easier to select on the screen.

You could have a go at scripting and expressions and stuff like that (programming that can help with some movements), but that is a path I have chosen not to go down (I want to be an animator not a technical director).

Always test your character out on a couple of scenes before you start animating in earnest and be prepared for it to fall to bits at any time. I will go into more sophisticated facial expressions in Chapter 12.

## chapter 10

# animation of acting – facial expressions

### chapter summary

- *emotions*
- *the eyes*
- *facial expressions*
  - happiness*
  - a smile*
  - sadness*
  - surprise*
  - fear*
  - anger*
  - disgust and contempt*
  - interest*
  - pain and distress*
  - combination of facial expressions*
- *head angle*
- *hand-to-face gestures*
  - evaluation*
  - deceit*
  - stress*
- *extreme close-ups*
- *how to animate a piece of facial acting*
- *exercises*
  - the facial expression in 2D*
  - the facial expression in 3D*

*animating the mouth with Blend Shapes in Maya*

*animating the mouth with Morpher in 3D Studio Max*

*animating the mouth with Animation Mixer in SoftImage XSI*

*animating with Morph Targets in Lightwave*

- *how to add a simple mouth and eyebrows to your basic 3D character*
  - the eyebrows*
  - the mouth*

We have the most expressive faces in the animal kingdom. With a combination of eight basic expressions we can pull around 5000 different faces all with slightly different meanings. The majority of these expressions are universal to all human cultures.

The face is used as a signpost to other people. It shows how we are feeling and what we want, or can be used to mask the way we feel. Almost half of our brain is concerned with seeing and almost half of this part of the brain is dedicated to recognizing human faces and facial expressions.

When we look at someone, we study the face. We look at the eyes, the eyebrows, the lips and the forehead. A combination of signals given by these give us information to form an opinion as to what the owner of the face is thinking.

When animating your character, because facial expressions can be very ambiguous and misleading, it is always best to work out the body language first and then add the facial expressions.

I have deliberately kept the illustrations and examples in this chapter as simple as possible. It's up to you to act out these emotions in a mirror to elaborate on them.

## **emotions**

Facial expressions are the ultimate demonstration of our emotions. We use the face to broadcast and communicate our emotions. Facial expressions are a form of behaviour that are caused by the contraction and relaxation of the facial muscles.

Facial expressions will be as a result of somebody hearing something, seeing something, smelling something, tasting something, feeling something or thinking something. As a character goes through a scene the facial expression will change depending on these stimuli. Think of each of these facial expressions as key positions and animate between them and hold them as necessary.



At its most simplistic, there are eight basic emotions: happiness, sadness, surprise, fear, anger, disgust/contempt, interest and pain.

These are inherited and not learned. Each of the basic emotions has an appropriate facial expression to display it. These are common to all human cultures. Some variations of these expressions are cultural specific and learned.

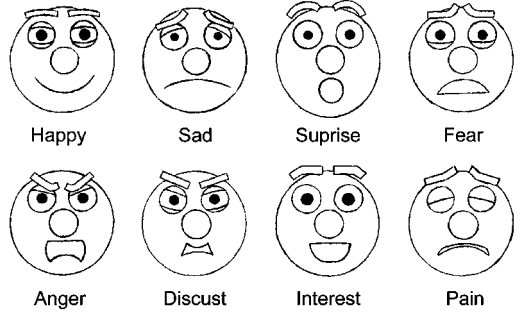

A combination of these basic facial expressions can appear on the face at the same time, such as happiness and surprise. All of these basic facial expressions can be varied depending on the intensity of the emotion portrayed.

The design of a character could emphasize a certain emotion. A down-turned mouth will make your character look morose, sad, angry or irritable. Heavyset eyebrows can produce the same effect. When this character displays an emotion other than the overriding emotion suggested by the design, the new emotion must be exaggerated to make up for the character's design.



True expressions are involuntary and display the emotion being felt by the character. They tend not to be held for long periods and flit across the face as the person changes mood.



deep emotion is being felt. For example a poker face when holding a royal flush!

Another example of a false expression is an emotion that is simulated when none is being felt; for example, the sincere face of a used-car salesman.

False expressions convey something other than how the character is feeling. Actors, liars, con artists, sales people, for example, use false expressions to varying degrees. I suppose animators do when animating their characters.

These false expressions can take the form of a character putting on a neutral face when a

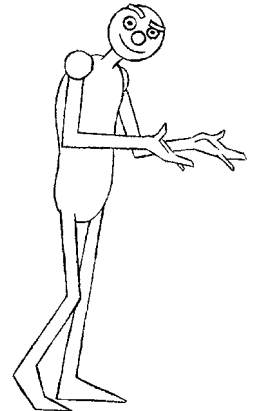

One further example of a false expression is one that is covering up the true emotion being felt underneath. Smiling when you want to cry.

Sometimes in animation, we tend to only include readable/appealing facial expressions; however, it's useful to include neutral almost undistinguishable expressions to compliment these.

## the eyes

'The eyes are the windows of the soul'.

The main feature which makes a character seem alive is the eyes. If the eyes are not focusing on something your character will look

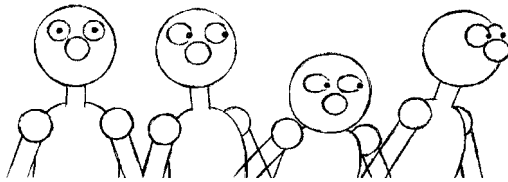

like a groggy doll. Always give your character something to look at either on screen or off. The only times your character will not be looking at something is when their eyes are glazed and looking into the middle distance or they have crossed eyes (when they are thinking or have been drugged or knocked out and are dazed).

The eyes will lead all movement of the face and body. When a character looks off screen the eyes will move first, then the head, then the shoulders and then a twisting at the waist.

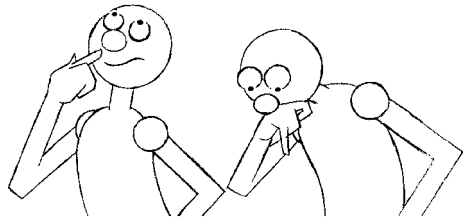

Following are some examples of emotions and the different looks connected with them.

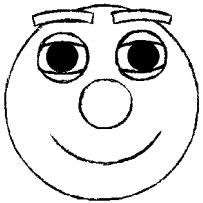

When a character is thinking they may also make a look. They could look up heavenwards for inspiration or down at the ground.

When a character sees something that they like or love the pupils of the eyes will dilate (they will get bigger). This will also make the character look more attractive or cute.

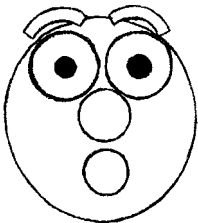

When a character is frightened the pupils will contract into tiny pinpoints. This also happens when a character is evil or hates something or is untrustworthy.

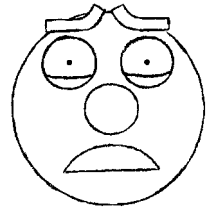

When a character is surprised the eyes will bulge, emphasizing the whites of the eyes.

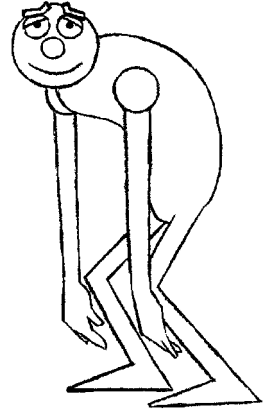

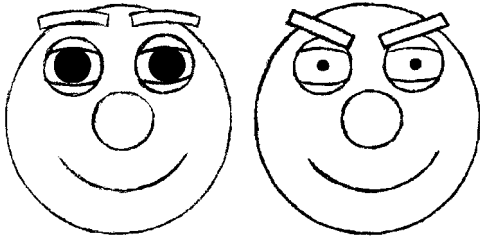

When a character is shifty and evil and appears to be happy, smiling and laughing, the eyes will narrow; reducing the white of the eyes visible.

When a character is feeling sexy and wants to give a sexy look, the upper eyelid is lowered

and almost cuts the eye in half. The head is usually turned away from what it is looking at. Combine this with fully dilated pupils for maximum effect.

The two main functions of a blink are to clean the eyes and to protect them from danger. When we blink we shut our eyes in different ways to portray different emotions.

A baby will blink infrequently and with a slow opening and shutting of the eyes. The opening and shutting will look very deliberate. Combine this with a direct stare and large pupils and you have a cute, loving look. This can be replicated by adults who are in love with the object they are looking like.

With a standard blink, the eyelid will close slowly and open quickly. By making the eyelids pop open quickly, the character looks alive and awake.

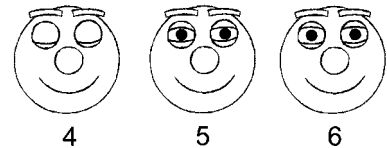
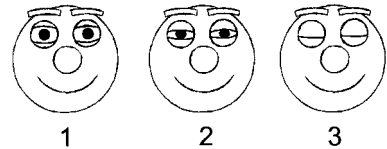
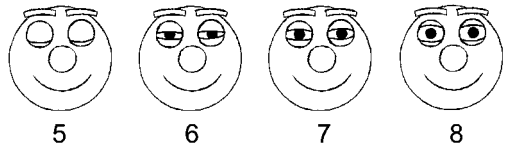
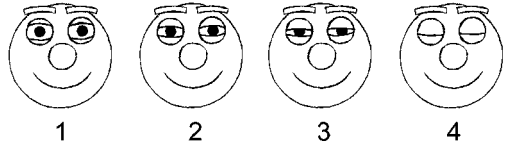
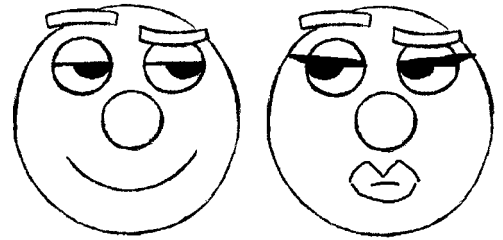
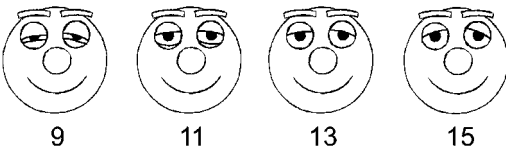
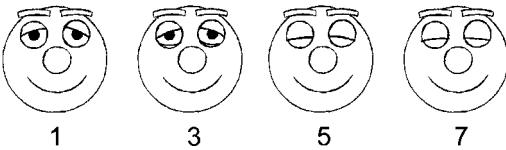

When somebody is sleepy or not very bright (stupid) the eyelids will shut slowly and open very slowly, with a lot of drag on the lids. This gives the impression that opening the eyes is a huge effort.

A real cliché when it comes to blinking is the fluttering of eyelashes. This happens when a feminine character tries to look attractive and get the attention of another character. The eyelids

will open and close quickly with the (elongated) eyelashes following though in an exaggerated manner.

When drawing the eyes (or building them in 3D) make sure that you take into consideration the

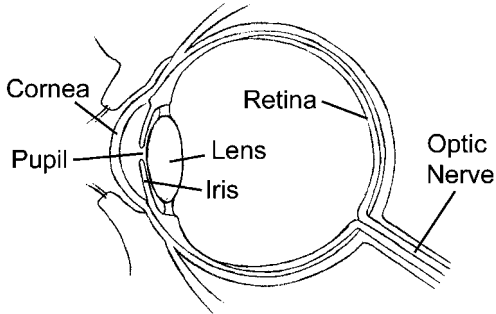

looking to the side, draw the pupil slightly through the outer line of the eye rather than on the inside of it. This will give more direction to the look and will make the eyes seem more three dimensional. Because of the exaggeration of this drawing it will also make it more cartoon-like.

## facial expressions

The facial expressions that portray the seven basic emotions are: happiness, sadness, surprise, fear, anger, disgust and contempt.

### *happiness*

There are different degrees of happiness, ranging from mild amusement through to ecstatic laughter.

### *a smile*

The eyebrows on a normal smile will be raised evenly. The corners of the mouth are raised, symmetrically, into a smile. This can be with the mouth open or closed. With the mouth closed the lips narrow and are stretched over the teeth and gums. With the mouth open, a smile can be with the teeth closed, exposing the teeth and gums or with the teeth open and the jaw dropped. Each of these mouth positions makes the emotion expressed more

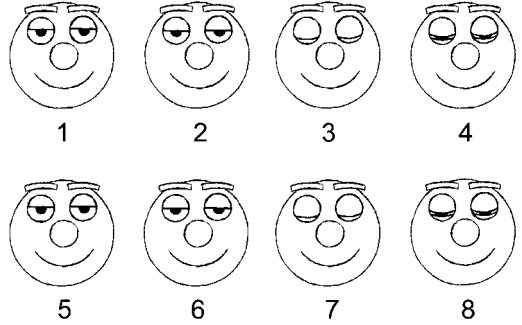

fact that the pupil and the iris have a convex lens in front of them called the cornea.

The way to illustrate this is with drawn animation; for example, when your character is

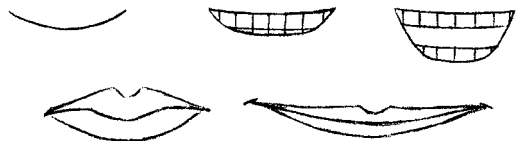
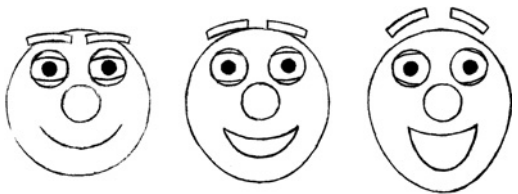
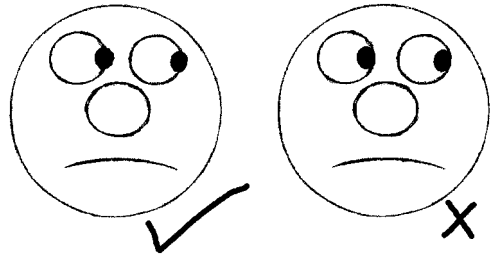

intense. The gap between the top lip and the bottom of the nose narrows. The lips will become thinner as they are stretched.

A furrow appears between the corner of the mouth and the nostrils on either side of the face, making the cheeks puff up and outwards. Depending on the width of the smile a furrow can form between the corner of the mouth and the chin on both sides of the face.

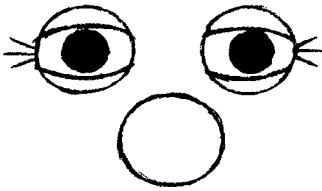

Crow's-feet form on the outside of each eye. A muscle around the eye contracts making the skin underneath it puff out. This narrows the eyes. The pupils will dilate to suggest the character likes what they are seeing or feeling. The ears can also move up.

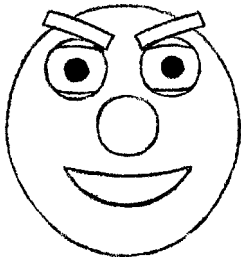

In a false smile the lips and eyebrows may be slightly asymmetrical. The muscles around the eyes don't contract so there are no crow's-feet or puffing of the skin under the eyes.

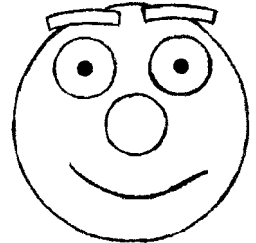

If the eyebrows are angled downwards and inwards, you get an evil smile. With this smile you could contract the pupils to make the character look more sinister.

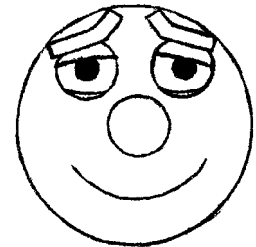

If you angle the eyebrows downwards and outwards, you get a forlorn, sad smile.

## sadness

This emotion can range from disappointment through to crying with despair.



The inner ends of the eyebrows will be raised and the outer ends lowered. This pushes the outer edge of the eye socket over the eyes. The upper eyelids may drop slightly. There will be concave furrows on the forehead.



The corners of the mouth will be turned down causing two furrows to run downwards from the nostrils to the chin via the corners of the mouth. The lower lip could be pushed upwards and

outwards, increasing this downturn. This can be accompanied by a depression immediately under the lip. This is particularly apt for the face of a sad baby.



The jaw can be dropped while the lips are still shut, this will give your character a long face. The mouth could open, especially during crying. Another thing that looks good is to make the bottom lip quiver.



When a character is sad the eyes may look downwards. During crying the eyes will be closed or almost closed. If a character looks to one side when sad the pupils could move slower.



False sadness could be given away by a slight curling up of the corners of the mouth, crow's-feet appearing at the outer corners of the eyes, puffy bags at the bottom of the eyes and an irregularity of the eyebrows.

## surprise

This emotion can range from slight surprise through to amazement. If the mouth has a smile you get a look of delight.

The eyebrows are raised high above the eyes and the forehead is furrowed.

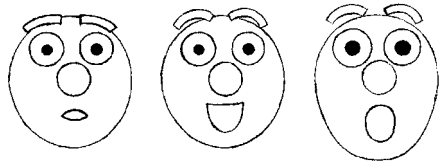

The eyeballs will bulge out, making the eyes look bigger. The eyes tend to stay fixed on the object that has surprised the character.

The mouth will usually be open with the jaw dropped. The mouth will take on an oval or round shape.

When the character is first surprised there will be an anticipation move and then a rapid movement of the head back

and a blinking of the eyes. The head may also shake from side to side.

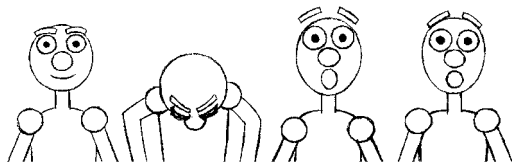

False surprise will be similar to the above but the movement will be slightly delayed. There may first be a slight look followed by the reaction. When animated the surprised look could be held slightly too long. The mouth could be squared off, as if it's being held open deliberately and the eyebrows could be uneven. The pupils will not be able to keep their fixed look on the object of their surprise.

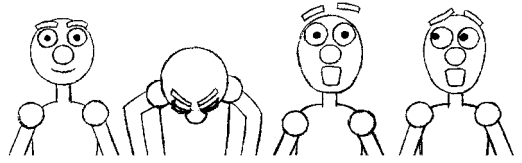

## fear

This emotion can vary from apprehension, through worry to shock and plain terror. The mouth will be open with the jaw dropped the corners of the mouth pulled outwards and downwards.

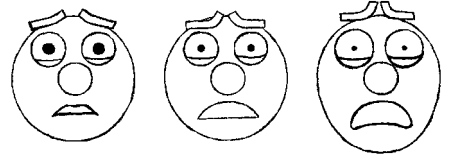

The eyebrows will be drawn together and raised and vertical lines will form on the forehead. Both the upper and lower eyelids will be raised, the lower eyelid being tense, pulling it straight across the eye. The pupils could be dilated.



Generally there would be a large amount of movement of the body and head through the main fear pose. Mock fear would involve an over the top face and body pose but the character staying still. The eyes may move more erratically.

## anger

This emotion can range from slight irritation to blind fury.

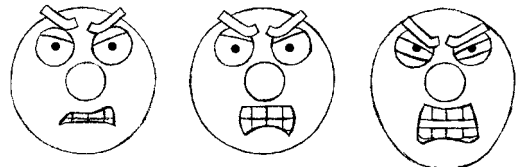

The inner ends of the eyebrows are pulled inwards and downwards. There will also be a fold of skin between the eyebrows. The eyebrows will press down onto the eyes. The eyelids could narrow or the eyes could bulge. The pupils could be contracted into tiny pinholes.

The nostrils can get bigger and flare out.

The baring of the teeth is considered as a sign of aggression.

The mouth can be closed with lips pressed hard together and the mouth narrow. This tends to suggest suppressed anger. The mouth can be open with the teeth clamped together and the mouth squared off or in a frown shape. The jaw could also be dropped with the teeth apart.



Sometimes it can be effective to make the character's face and body vibrate or shake with suppressed rage. This can be done either with the head staying on the spot, or following a path up and away from what the character is looking at or down and towards it. Draw two key positions and in-between them evenly. Stagger their shooting.

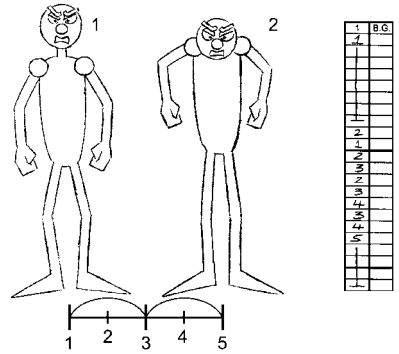

A false display of anger will involve this expression being forced onto the face. The mouth may be crooked, as are the eyebrows. The character won't be able to keep this face up for long and, hopefully, will collapse into a fit of giggles or a big smile.

### *disgust and contempt*

Disgust is an emotion that can range from dislike through to nausea.

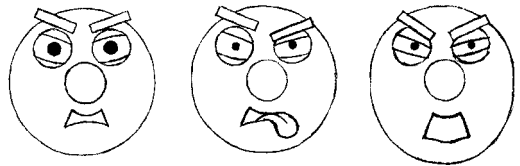

This involves pulling the head

away from the object of disgust. The chin is tucked into the neck or body. The eyebrows are lowered and pulled together horizontally. This causes wrinkles to form around the bridge of the nose and on the insides of the eyes. The eyes are narrowed and the pupils are contracted.



One or both corners of the upper

lip can be raised (raising one corner of the lip gives a more contemptuous look). This makes the furrow between the nose and the chin take on a squared-off shape. If the mouth remains closed the lips will be pressed tightly together.



With a false look of contempt, the character needs to occasionally slip slightly out of the contemptuous look.

### *interest*

This emotion can take many forms, alertness, attentiveness, expectancy and anticipation. It's really an elaboration of other expressions.

The eyebrows can be raised, producing a furrowed forehead. Both of the eyebrows could be brought together. One of the eyebrows could be higher than

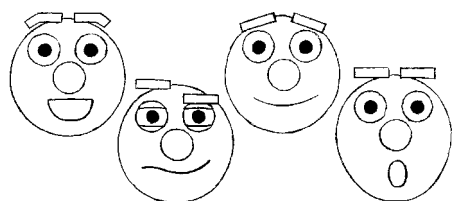



the other. The pupils could dilate and will always stare unblinkingly at the object of interest. The eyebrows are positioned like surprised facial expressions but the mouth usually has a smile.

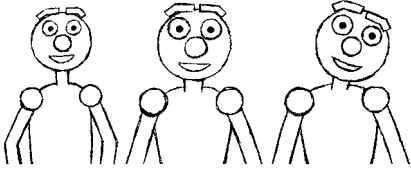

The head could be brought forward and even put onto one side.

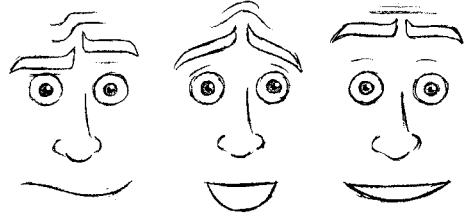

Interest and excitement usually are accompanied by another facial expression such as surprise or happiness.

The opposite of interest is boredom. The face becomes relaxed and unanimated; the eyes will droop and look up or straight ahead, not focusing on anything. The whole upper body may lean forward until the character catches themselves and moves suddenly back to an upright position. The character could also fiddle with things to occupy them. Yawning is a good sign of boredom.

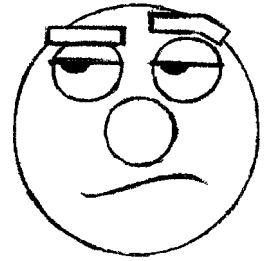
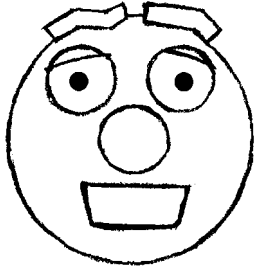

Somebody feigning interest will hold any of the poses described earlier but will occasionally lapse into boredom, making any of the above gestures for a short period and then reverting to the positions of interest.

### *pain and distress*

This emotion can range from discomfort through to extreme pain.

The mouth could be open and squared off, the jaws open, or shut with the jaw tightly clenched.



The eyebrows are drawn together with the inner ends up and the outer ends down.

They could switch to be the other way round. The eyes will be shut for most of the time.

Generally the face is screwed up and will move from one configuration to another, whilst the character is feeling pain or distress. The look is almost like a cross between sadness and anger.

When somebody is putting on pain, they will recover remarkably quickly. Somebody in real pain will feel it for a long period of time.

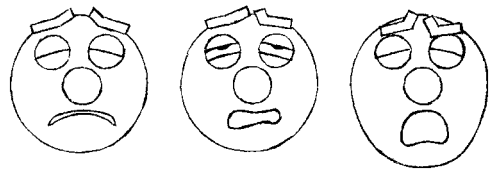

## combination of facial expressions

As I said earlier there can be any number of combinations of these basic facial expressions happening at any one time. Here are a few examples deliberately drawn as simply as possible to allow you to see the basics of facial expressions. The best thing to do is to watch yourself in a mirror pulling the expression you want to animate. To re-enforce the point; there is nothing better than acting and observing the emotions you want to express in animation. So get acting. Don't be self-conscious. Don't worry if people think you are mad. If an audience understands your animation, you have done a good job. If it means rolling around on the floor and people laughing at you, so be it!

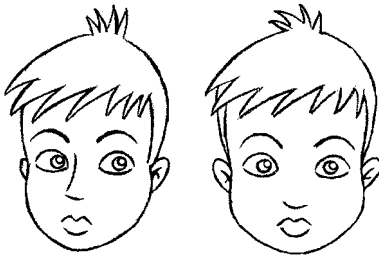
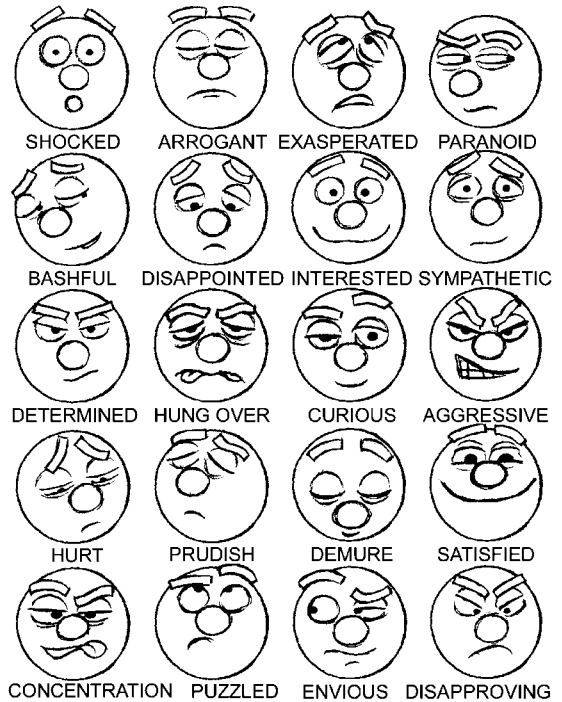

Only rarely will you see a character in an animated film face directly at the camera, especially in drawn animation. It's acceptable to hold a straight-on face at the end of a movement but when doing a head move from one

side to another, do not have a drawing or image where the head is straight on to the camera. Make sure all the heads are at a slight angle.

This is because a drawing of a face that is straight on will often look different in character to one that is slightly side on. A view straight on can look open and innocent or intense. A side on view will seem more guarded. This is also true of both puppet animation and 3D-computer animation.

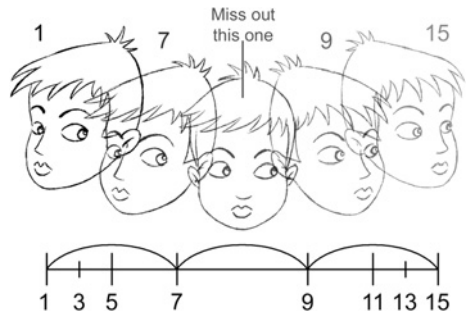

When moving a head quickly it's fine to distort it along the path of movement, but always keep the cranium the same shape and size. Distort the cheeks, jowls and the jaw.

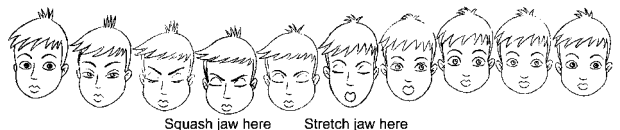

Have a look at `distorted_head.avi` in `animations010`, chapter010 of the CD-ROM.

## head angle

The head moves in an arc in relation to the neck and shoulders. The expression on the face is important but the angle of the head has to be right.

Angling the head forward but upwards indicates a willingness to engage, either the character is interested in something or wants to challenge it head on. Angling the head forward and down can give an argumentative or determined look. It can also give a tired or stupid impression.

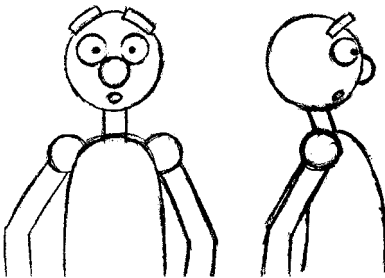
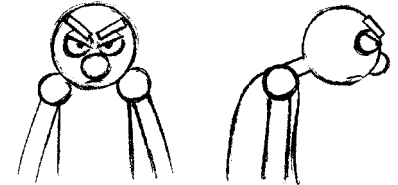
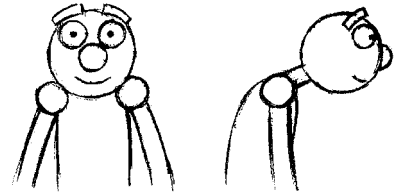

Angling the head backward and upwards gives an arrogant or snobbish look. Angling the head back and down gives a frightened or nervous look.

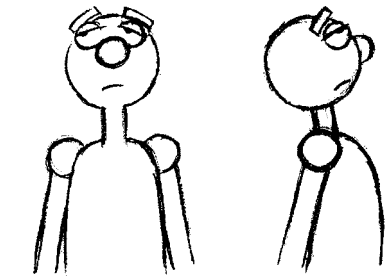

Angling the head to the side can indicate that somebody is looking to one side, if the eyes are looking in the same direction as the head. It can also indicate that somebody is shy of something or interested in something but wants to cover his or her interest. If somebody is attracted to somebody else they will look at this person directly. If the attractive person looks at them they will angle the head away, but sneak a look with the eyes.

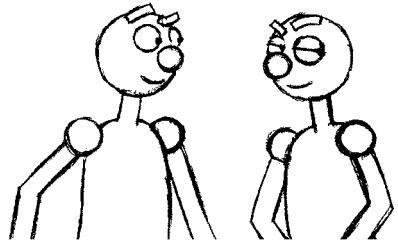

Rotating the head to one side while looking directly at somebody is an asking gesture. The person doing this action wants something from the person they are looking at. This is a very deep-seated gesture that is seen a lot in young children.



## hand-to-face gestures

People frequently touch their faces. This will take place while they are listening to something, seeing something or feeling something, while talking to somebody during a conversation or when contemplating something. The relevance of these gestures depends on the way they are done and the emotion being felt by the person.

These gestures can be divided up into the following categories; evaluation, deceit and stress.



### *evaluation*

If somebody is considering something they may stroke their chin or support their face delicately.

If somebody is bored they will support their head with their hand as if their head were heavy.

### *deceit*

When a young child is telling a lie they will often cover their mouths involuntarily, as if they are trying to cover up the lie they are saying.

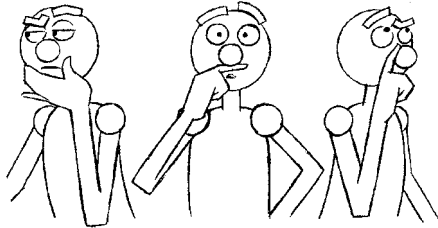

Adults will do a similar action but will try to disguise it by turning the gesture into something else. Touching the nose or cheeks, gives the impression of somebody who is being economical with the truth.



telling a lie they may also do a 'mouth cover' gesture, giving the impression that they doubt what they are hearing.

If a person is rubbing their eyes this could be because they are tired or it is because they want to avoid eye contact with the person

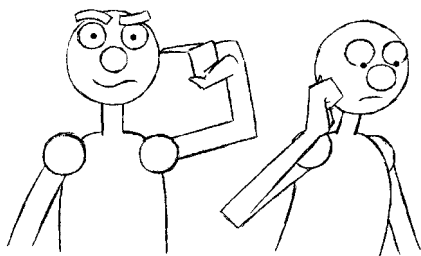

they are lying to or they don't believe what they see. The eyes may also move more erratically.

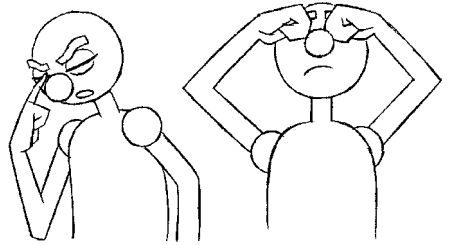

Rubbing or generally fiddling with the ears indicates somebody doesn't believe what they are hearing or they are telling a lie.

Rubbing or generally fiddling

Scratching the neck or pulling the collar indicates that somebody is feeling nervous because they are telling a lie or that they are angry or frustrated.

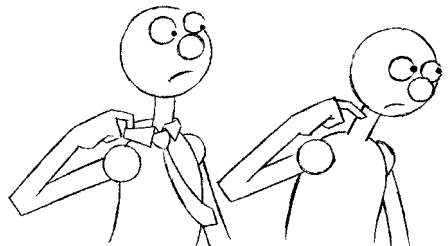

## stress

When somebody is stressed, nervous or frightened they will stick their fingers in their mouth for comfort. Biting the finger nails is a complication of this.

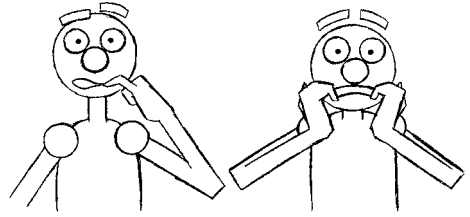
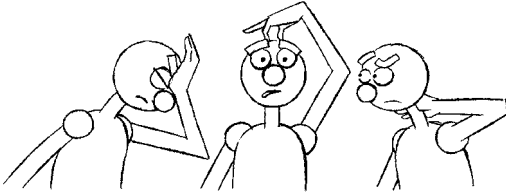

Slapping the front of the forehead, scratching the top of the head or rubbing the back of the neck are also signs of stress or frustration.

## extreme close-ups

In many live action films there are often extreme close-ups of the main actors. This is where you have only the eyes and nose in screen. These sorts of close-ups tend not to work so well in animation. With drawn animation it's difficult to decide how thick the line should be. Drawing the lines can be problematic because the audience very easily sees any inaccuracy. It is easy for the lines to wobble and ooze. This makes an audience stop believing in your characters. With 3D computer animation line wobble is less of a problem but close-ups of polygons or skinning or texture mapping never look quite right and make an audience uneasy about your characters. If you must do an extreme close-up keep it quick (less than 2 seconds).

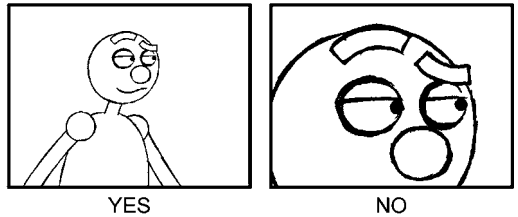

## how to animate a piece of facial acting

How do you put all of this information together? How do you make your character live and breathe and express themselves? Well, we as humans look at other people and work out what they are thinking by the signals displayed on their faces and the body language they adopt. Use this with your character. Work out what they are thinking and make their face and body language display this thought. Most of the acting your character does is as a result of reacting to something that happens to them. They may see something, hear something or feel something and the result of that reaction will be seen on the character's face and in their body language. The main thing to work out is how long an audience needs to see a facial expression to understand what the character is thinking. So think about your character moving from one pose to another (one facial expression to another). Think about how long they adopt that pose for and what they may do while in that pose and vary the way the character moves into each of these poses.

First think about what your character has to do in a scene. Think about it for as long as possible. If you can go out for a walk or have a cup of coffee – do it! Act it out in front of a mirror or videotape yourself (or if you are very persuasive, somebody else). When you have

decided what your character has to do, write it down in list form in as simplistic a way as possible. Write down the minimum that your character has to do to make the scene understandable to an audience (when you start animating you can elaborate on it). Write down some notes about how many frames each of these poses needs to be seen for. If you're not sure, guess.

- ① A CHARACTER IS SAT CENTRE SCREEN. HE HAS A SAD LOOK ON HIS FACE.
- ② HE NOTICES SOMETHING SCREEN RIGHT (HIS EYES LOOK SCREEN RIGHT)
- ③ HE LOOKS SCREEN RIGHT WITH A HAPPY LOOK ON HIS FACE.
- ④ AS HE IS LOOKING SCREEN RIGHT HIS EXPRESSION CHANGES TO A LOOK OF HORROR AND HE LEANS BACK.
- ⑤ HE THEN LOOKS BACK TO CAMERA WITH AN ANGRY LOOK ON HIS FACE.

You could write this directly onto an x-sheet in the action column, marking the frame where each of the poses takes place. If you're not confident enough with your timing, shoot the drawings first and then make changes. When you are happy with the timings mark them down on an x-sheet.

Whether you use x-sheets or not, always note down your timings. There is no way that you will be able to keep all this information in your head and animate.

Once you've sorted out this list, do a drawing that illustrates each of the items on the list. Just do very rough thumbnail sketches.

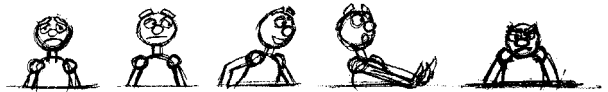

Shoot this collection of thumbnail drawings as a 'pose test' on a line tester (take a look at `acting_quick_thumbs.avi` and `acting_slow_thumbs.avi` in `animations010`, chapter010 of the CD-ROM).

Vary the amount of frames that each of the pose drawings is held for until it works as a pose test (i.e. the audience has just enough time to clearly understand what each of the facial expressions is and means). Mark this on an x-sheet (slug it out). Then draw each of the drawings full size (or blow them up on a photocopier). Now you can start animating them. Think how long the audience needs to

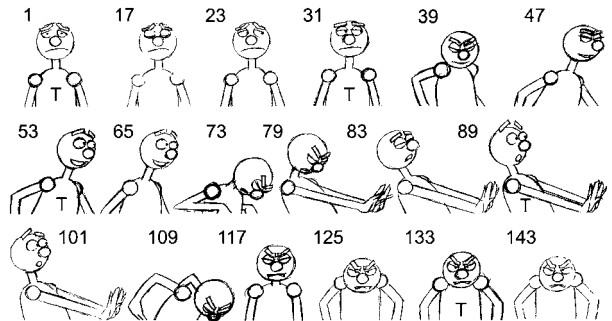

register an expression. An audience needs a minimum of half a second. Always keep thinking of your audience and whether they will understand what is going on. Draw all the key positions. These are all the poses where the character adopts a posture and facial expression. Do a key position at the start of these poses and one at the end just before you anticipate into another pose. If a character does something while in this pose (look at a watch for example) sort out key positions for this action. Do the anticipation keys out of a pose and the overshoot keys into the next pose. When they are done shoot them on a line tester and fiddle with the timing again.

The subtlety of the animation depends on the positions of the anticipation keys and the speed and arcs of the in-betweens. In this and the previous illustration, I've used the same basic key positions as the thumbnail sketches (those positions marked with a 'T') but changed the amount of frames between these major keys. I have also changed the anticipation and overshoot keys. The previous illustration has quite extreme anticipation and overshoot positions and moves between these positions quickly (less frames). As such it has a sharper 'pose-to-pose' feel. This illustration has much less extreme anticipation and overshoot positions and the movement between these keys is slower (more frames). This gives it a more full animation look.

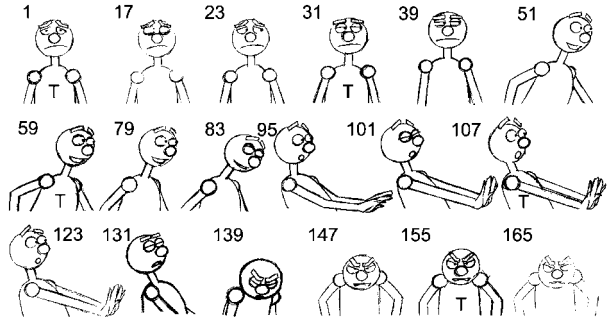

Take a look at *acting\_quick\_keys.avi* in *animations010*, chapter010 of the CD-ROM to see the timing of the illustration on p. 229. Take a look at *acting\_slow\_keys.avi* in *animations010*, chapter010 of the CD-ROM to see the timing of the above illustration.

When you reach each of the expression poses, don't just have your character staying stock-still. This will make your character look dead. Give your character something to do when in one of these poses. One of the best things is to slightly change the expression on the character's face. For example when our character sees something and moves into a pose where they look happy have your character slightly move forward slowly and increase the size of their smile.

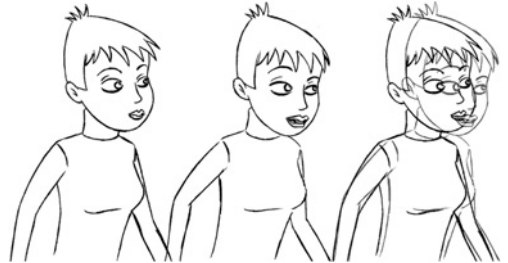

This can be used with all facial expressions within a pose. You could go from a small expression to a larger one, a large expression to a smaller one or from one expression to another.

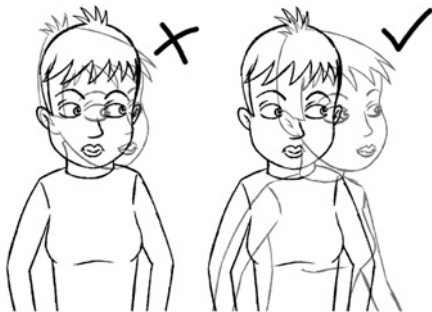

It's always a good idea to move the head and upper body slightly in these instances. Keeping the head clamped to the spot will look stiff and wooden. Remember almost everything moves in an arc and a lot of the movement of the upper body stems from the base of the spine. Don't just move

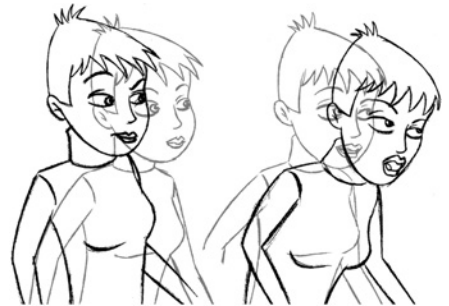

the head on its own without some shoulder movement and upper body movement. In order to compensate for the movement of balance at the top of the body the legs will have to bend and shift to maintain the correct balance. So even a simple look to the side of the screen may result in the whole body moving.

In a situation where your character is moving while pulling a facial expression that the audience needs to see, you have to keep the expression the same while the character is moving and hold that expression for longer. Don't try to change the expression on the character's face because there is already a lot going on and your audience won't register the change. This is called a moving hold. Moving holds aren't limited to the face. The hands could stay in the same position (for example, when the character is pointing) while the rest of the body is doing something else.

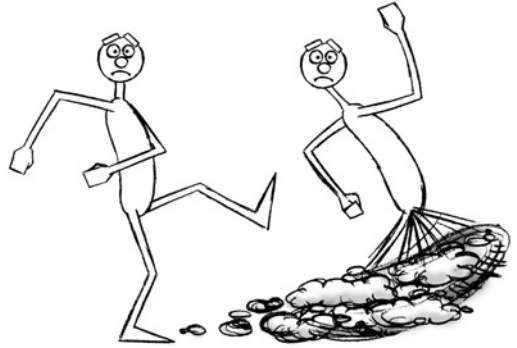

Another way to make sure an audience sees an expression (for example, when a character is falling out of screen and is looking at the audience), is to move the head slightly as the body moves rapidly. This gives an impression of the head being left behind while the neck stretches. When the audience has had enough time to see the face (8 to 12 frames) it then zooms out of screen after its body.

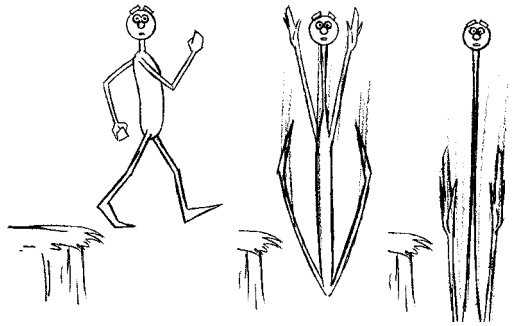

What happens when your character is constantly moving in a scene and there isn't time to adopt any poses?

When you have to cram many facial expressions into a small amount of time, you will need to 'snap' the facial expressions from one to the other, as the character moves. You need to ensure the audience has enough time to register each expression during the movement. In simple terms, this uses several moving holds in a row. If you make the character screw their face up from one expression and then pop it out into another, this can work well.

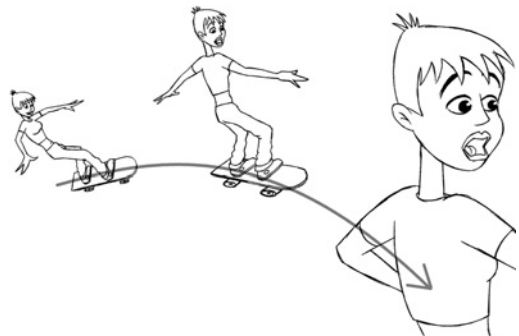

Anticipation and overshoot can be used within the face to get from one facial expression to another. For example if a character is happy and they see something that makes them sad,



their happy expression could first become more happy (bigger smile, narrower eyes, more crow's-feet) and then they can move the facial features into a frown. Make the frown slightly more exaggerated to start with and then tone it down slightly during the pose.

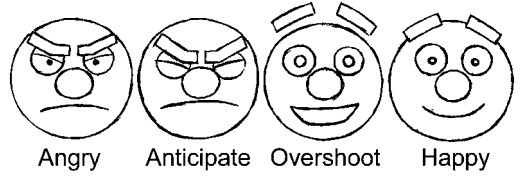

One of the main problems with sorting out the poses first and then completing the in-betweens is that you can end up with a rather stiff and wooden, clunky piece of animation. One way around this is to use your pose drawings as a 'marker post' to aim for and animate everything straight ahead, hopefully ending up at points roughly the same as your pose drawings. If the pose drawings have to be changed slightly, so be it. Animate everything in rough first.

## exercises

### *the facial expression in 2D*

One of the simplest exercises to explore facial expressions is as follows: a character is sat centre screen, facing towards us, with just the head and shoulders in view. It sees something off screen and pulls a facial expression as a result of what it has seen. The character then realizes that it's not quite what it seems and changes the expression as a result. The character then looks back at the camera with another expression.

Work out a list of what the character will do (as in the top illustration on p. 229). Then draw a series of thumbnail sketches and test them. Slug out the basic timing onto an x-sheet and draw the thumbnails full size, adding extra key positions for anticipations, overshoots and held poses. Work out the timing charts so you have a reminder of how to complete the in-betweens.

Here is one interpretation of this scenario (I've made it very over the top).

First draw a series of thumbnail sketches. Have a look at the thumbnail sketches in the middle illustration on p. 229 and the series of pose drawings in the bottom illustration on p. 229.

The following exercise uses the bottom illustration on p. 229 as a guide.

Start with our character centre screen, looking sad. The character blinks and glances to screen right.

The character does a double take and looks screen right with a happy look on its face.

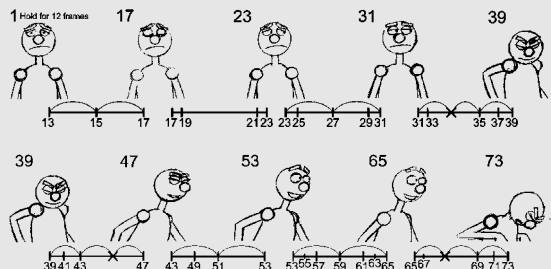

The character then recoils back in shock.

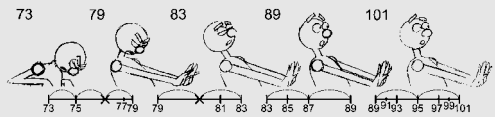
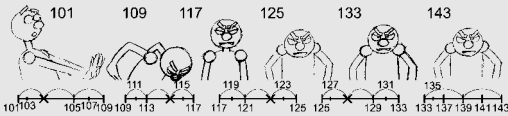

The character then turns back towards the camera with an angry look on its face.

Take a look at `acting_quick_2D.avi` in `animations010`, chapter010 of the CD-ROM.

It may help you to think about what your character has seen and why they have reacted in this way. In the example above, the character has seen an ice cream van and smiled at the thought of getting an ice cream. It then notices the extortionate price of the ice cream and recoils back in horror. The character then looks at us angrily because it can't afford one.

Other suggestions for close-up exercises are as follows.

A character is sat centre screen holding a telephone listening to the receiver (make it a mobile phone – no wires to worry about). Depending on what the character hears, its facial expression will change from one look to another. Do about four facial expressions and use expressive body language to augment these.

A character is sat at a table waiting to be served a meal. It is taking a long time to turn up which is annoying. The character looks to one side to see the plate placed in front of it. The character looks down at the plate with a happy expression and licks its lips. The character forks up a portion of food and pops it into its mouth with a look of ecstasy on its face and starts chewing. The face turns to one of disgust as it realizes that the food tastes awful. The character spits the food out and looks angrily in the direction that the food came from.

A character tries to attract somebody's attention off screen (make it to one side of the screen or the other – it's much more difficult to do this straight to the camera). They may be waving and smiling or looking angry and waving their fist (anything you want). The character is ignored by the person off screen. They react as a result of being ignored. They may get angry (or angrier) or become sad or nonchalant (again it's up to you).

A character is trying to complete a complicated task, for example build a house of cards. As they place one set of cards against another there is a look of concentration on their face. When they place the final two cards at the top, they have a look of triumph. They might then sneeze and blow the house down and end with a fed up look on their face. Think about there being three major facial expressions.

A character could be sat watching TV and reacts as a result of what is seen and heard. Again think of three facial expressions and how to get from one to another.

### *the facial expression in 3D*

There are two ways of animating facial expressions in 3D.

You can put bones into the head and make each of the bones operate a distinct feature on the face (for example the corner of the mouth). It's as if a bone is replicating one of the muscles of the face. This method can be quite confusing because there are a vast amount of muscles in the face and you could end up having hundreds of bones trying to control them all. I think of this method as being like puppetry, the bones opening and shutting the mouth like the fingers of a puppeteer operating a glove puppet.

The other method is to build one head (or mouth) and then copy it and re-model it so it is pulling a new facial (or mouth) expression. Save this head, copy the original head and then give this third head another expression. Continue doing this until you have enough facial expressions to do the piece of animation you want to do. You then get your program to morph from one facial expression to another, saving keys as you go. This can make the face look as if it is oozing from one expression to another if it is not done right and if you aren't thorough it is easy to miss building one expression. However, it is the most popular method professionally. I think of this method as being similar to model stop frame animation where they have several heads that they replace one after the other depending on what facial expression is required. It's also similar to clay animation where they sculpt each facial expression from one frame to the next.

The model on the CD-ROM is built using the morphing method and in order to keep it as simple as possible it consists of a stick on mouth that is morphed from one shape to another.

Copy the folder that contains your model (mayaman\_mouth, maxman\_mouth, lightwaveman\_mouth or xsiman\_mouth) onto the C drive of your computer (in the case of xsiman\_mouth copy this into the data folder).

Load up mayaman\_mouth.mb (Maya), maxman\_mouth.max (3DS Max), lightwaveman\_mouth.lws (Lightwave) or xsiman\_mouth.scn (SoftImage XSI). These are in the folder man\_mouth\_models in chapter010 of the CD-ROM.

It's basically the same model as the character but with a mouth and eyebrows. The mouth can be morphed to produce different mouth shapes (each program uses a slightly different method), the eyebrows are moved by bones inside them. I'll go into more detail about how to morph the mouths in each individual program later in the chapter.

The majority of facial expressions can be done with a minimum of 11 basic mouth shapes and



the position of the eyebrows. The same basic mouth shapes can be used to speak the majority of words.

These consist of neutral, smile, frown, big smile, big frown, oh (like when you say the word pot), ooo (like when you say the word pool), anger, yuk (as in disgust or contempt), fvbpm (the bottom lip is tucked under the top lip when you say these consonants) and Elvis (one corner of the lip is pulled up).

Take out your animation drawings of your expression change acting (or copy the positions from the illustrations in the exercise section on facial expression in 2D). Work out the body language and the eyebrows first by setting keys for the whole body and head all the way through the scene.

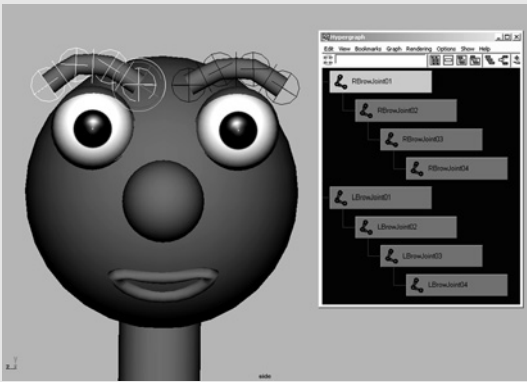

The eyebrows have bones (joints) running through them and can be rotated and moved. They can have keys saved on them as with any other bones. They are called R\_Brow and L\_Brow. The bones within them are called R\_BrowBone01, etc.

To one side of the character there is a pile of mouth shapes. These are the reference shapes that the mouth on the face of the character can morph

to. Always keep them out of scene, otherwise you end up with strange mouths floating around.

For the example of `face_acting_3D.avi`, the mouth shape is a frown between frames 1 and 31. It is then neutral for frames 33 and 35. It's a smile between frames 37 to 41. It becomes a big smile between frames 43 and 67. It goes into a frown between frames 69 and 79. It then goes into a half oh shape and a half frown shape between frames 81 and 85. Between frames 87 and 101 the mouth is an ooo shape. Between frames 103 and 115 the mouth is in a frown position. And for the remainder of the scene the mouth is in an angry position.

Hopefully you will have something that looks like `face_acting_keys_3D.avi` in `animations010`, `chapter010` of the CD-ROM.

All that needs to be done now are the breakdown positions to help sort out the way the computer in-betweens between the key positions. Follow the timing charts from the illustrations in the exercise section on facial expression in 2D.

Once this is done you should end up with something like `face_acting_3D.avi`.

## *animating the mouth with Blend Shapes in Maya*

First animate the body, head, eyes and eyebrows.

Open up the Blend Shape window by going to the Main Menu > Window > Animation Editors > Blend Shape. In the Blend Shape window are a series of sections called blendShape1 through to blendShape10. These are the controls that relate to the different basic mouth shapes. They can be maximized or minimized by left clicking the triangle next to the word blendShape ....

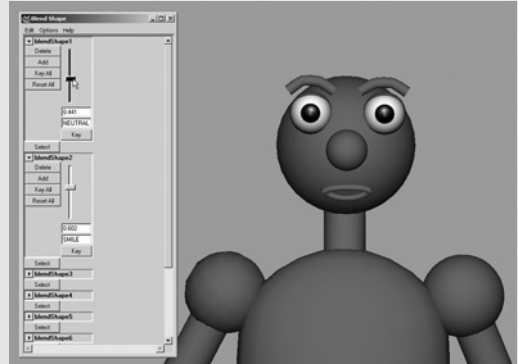

Maximize one of them and you will see that it consists of a slider and several buttons that relate to creating and deleting keys. Move one of the sliders and the mouth on the face of the character will change. We create movement of the mouth by moving the Time Slider to the correct frame and then moving a Blend Shape slider to a position where the mouth is the right shape and then setting a key by clicking the Key button underneath the Blend Shape slider. You can change the value of several of the Blend Shape sliders to get almost any mouth shape you could ever want.

Go through your animation and at the appropriate points change the shape of the mouth to suit your drawings (or the illustrations in the exercise section on facial expression in 2D). Keep experimenting with different mouth shapes until you have something you are pleased with.

Take a look at face\_acting\_3D.avi in animations010, chapter010 of the CD-ROM.

## *animating the mouth with Morpher in 3D Studio Max*

First animate the body, head, eyes and eyebrows.

Select the mouth in one of the views and make sure the Modify tab is selected in the command panel. Make sure Morpher is selected in the Modifier Stack. In the Channel list there is a list of all the mouth shapes (apart from 'oh' which is the mouth shape you get to start with). Next to each of the mouth shapes are boxes that have percentages in. When you vary the percentage number in the box, the mouth on the character's



face will morph into the mouth shape named by the box. 0 means 0% of the mouth shape and 100 means 100% of the mouth shape. Have a practice by changing the percentages of one of the mouth shapes. Go into animation mode (outside of views goes red) change the mouth shapes as they are needed and set keys on them.

Go through your animation and at the appropriate points change the shape of the mouth to suit your drawings (or the illustrations in the exercise section on facial expression in 2D). Keep experimenting with different amounts of mouth shapes until you have something you are pleased with.

Take a look at face\_acting\_3D.avi in animations010, chapter010 of the CD-ROM.

### *animating the mouth with Animation Mixer in SoftImage XSI*

First animate the body, head, eyes and eyebrows.

In the top left view port, open up Animation Mixer (left click on the views menu and choose Animation Mixer). Click update. Right click on a track (one of the horizontal green bars going across the window) and choose Add Track>Shape twice to create two shape tracks.

In the bottom left view ports, open an explorer (left click on the views menu and choose Explorer) Make sure that Show > Mixers is selected. From the explorer list open up Scene\_root\ Mixer\Sources\ Shape node. There you will find each of the 11 mouth shapes. These mouth shapes can be dragged and dropped



onto one of the shape tracks in the Animation Mixer, where they become a 'clip' (not dissimilar to a movie editing program like Adobe Premier). When on one of the shape tracks the clips can be dragged shorter or longer, they can overlap each other from one shape track to the other to create further shapes and the clips can be mixed from one to the other by going to Mix > Standard Transition Tool. Left click on one clip and then left click onto the clip you want to mix to and a transition will be created (right click to get out of this mode). If you scrub the timeline back and forth, one shape will mix to the other. There is no need to set keys.

Go through your animation and at the appropriate points drag the shape of the mouth to suit your drawings (or the illustrations in the exercise section on facial expression in 2D) from the explorer onto the shape tracks of the animation mixer. Keep experimenting with different mouth shapes until you have something you are pleased with.

Take a look at face\_acting\_3D.avi in animations010, chapter010 of the CD-ROM.

## *animating with Morph Targets in Lightwave*

First animate the body, head, eyes and eyebrows following the drawn example.

Select the mouth shape on the character (the starting shape is 'oh').

Open up the Object Properties and choose the Deformations tab. Select the Current Object as oh and select the Morph Target as smile (or whatever mouth you want). Left click the E button next to the Morph Target box and up will come the Graph Editor with the curve that relates to the oh there already. From the Keys menu in the Graph Editor select Create key. Up will come the Create key window. Leave Frame at 0 and leave Value at 0% as well. Left click OK. Select Create Key again and this time set Frame to where you want the next mouth shape to be (let's say frame 10) and put Value to 100%.

This will make the mouth01 morph to 100% of mouth02 at the frame you've set your key at (you could also set the key at 50% or any other percentage if you like). Then for the next mouth shape, put the word smile (the mouth shape that was the Morph Target) in the Current Object box of the Object Properties window and make the next Morph Target yuk. Tick the Multi target/Single Envelope box. Then create the next key and set it at 200%. Continue in this vein. Each subsequent mouth shape will occupy the next 100% of the graph. So the third mouth shape would be at 300% the fourth at 400%, etc. You can jump back to other mouth shapes (by specifying a lower percentage at the relevant key) and you can also scale and move the lips as well.

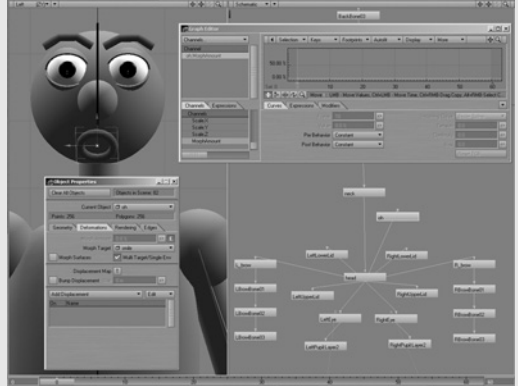

Take a look at `face_acting_3D.avi` in `animations010`, `chapter010` of the CD-ROM.

## **how to add a simple mouth and eyebrows to your basic 3D character**

There is a ready built character with a mouth and eyebrows that you can have a go at animating with. However, if you want to have a go at putting a mouth and eyebrows on to your man before you animate, here are some basic instructions.

Most expressions carried by the face are produced by a combination of the eyes, the eyebrows and the mouth. It's amazing that so many faces (over 5000) can be produced with such basic raw materials!

The basic man that you built in Chapter 3 only has the eyes, now is the time to add eyebrows and a mouth.

There is a software specific .pdf file in chapter010 of the CD-ROM called 'making mouths.pdf'. Have a look at this to get a more detail idea of how build the mouths.

## *the eyebrows*

The eyebrows are made from two small cylinders with at least 3 subdivisions down them (five would be better). This means that when they are manipulated they will produce smooth curves.

Next put several bones through each eyebrow (at least 5 bones). 'Skin' the eyebrow to the bones so that when the bones are moved or rotated the eyebrow will move with them.

Place the eyebrows in an eyebrow like position above the eyes. They are going to 'float' it this position and be moved in order to pull a specific facial expression. Finally link the first eyebrow bone, of each eyebrow, to the head bone so that the eyebrows will move with the head.

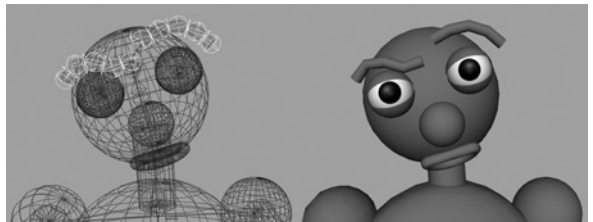

To create certain eyebrow positions, select each bone in turn within the eyebrow and rotate them. To raise or lower the eyebrow, select the first eyebrow bone and move it up or down.

## *the mouth*

For our basic man I've kept the mouth as simple as possible. It consists of a 'torus' or donut shape. The mouth will look like a rubber ring, attached to the head and squashing and stretching into different shapes as the man speaks.

First create your torus shape, then place it under the nose of the man and link it to the head bone so that the head is moved.

We now have to replicate this shape 10 times and arrange these 10 toroids next to the man. Each shape then has to be manipulated into one of these 10 mouth shapes (11 including the first torus you created). Each of these mouth shapes has then to be assigned to the original mouth shape it was duplicated from. Each program has a slightly different way of doing this, so have a look at the 'making mouths.pdf' in Chapter010 of the CD-ROM to find out how to do it.

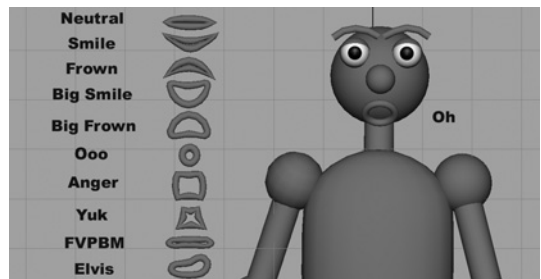



The majority of facial expressions can be done with a minimum of 11 basic mouth shapes and the position of the eyebrows. The same basic mouth shapes can be used to speak the majority of words.

These mouth shapes consist of 'neutral', 'smile', 'frown', 'big smile', 'big frown', 'oh' (like when you say the word 'pot'), 'ooo' (like when you say the word 'pool'), 'anger', 'yuk' (as in disgust or contempt), 'fvbpm' (the bottom lip is tucked under the top lip when you say these consonants) and 'Elvis' (one corner of the lip is pulled up).

You then use the appropriate tools in each of the programs to change the mans mouth shape to the desired expression, setting keys as you go. You can also use a combination of different mouth shapes to create new ones.

## chapter 11

# animation of acting – two or more characters

### chapter summary

- *two characters on screen together*
- *the use of 'beats' to break up a scene*
  - objective*
  - obstacle*
  - action*
- *personal space*
- *mirroring*
- *how characters look at each other*
- *two characters acting with each other while talking*
- *two characters alternating from one shot to another*
- *a large group of characters on screen at the same time*
- *exercises*
  - double acting in 2D*
  - double acting in 3D*
  - how to load two identical characters into the same scene*

## two characters on screen together

Two characters in a scene together will interact with each other. Even if one is ignoring the other, there will be a certain level of interaction.

When two characters interact the action should be like a game of tennis. One character will have the audience's attention, then the other character. Divide a scene to make sure the action and events happen at different times. If one character acts, the second character responds to this.

Then the first character reacts to the response. If the two characters do something at the same time it will be too confusing for the audience and they will miss part of the action (unless this is what you want).

When one character is performing an action the audience must see, the other character should make a minor movement. This should be just enough to keep them looking alive, but not so much that they start to distract attention from the action that matters.

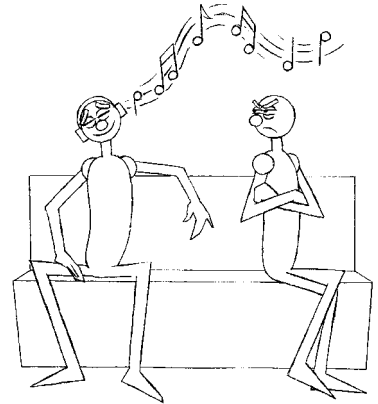

## the use of 'beats' to break up a scene

Within a scene or monologue (and it doesn't matter if it's a film or a stage play) there will be a series of 'beats'. A beat will separate one section of the scene from the next. It's not just a pause in the dialogue or action. Every time there is a change in dynamic, emotion, or purpose, there is a change in beat. The dynamic changes can be when somebody new enters the scene, or when a character reveals something unknown to anybody else or when one character becomes more important in relation to the other. A change in emotion or purpose is where a character performs a series of actions; he or she does things. He or she does things because he or she wants something and is prevented from getting it. A **character beat**, the unit of action for a character, therefore has three parts.

### *objective*

The specific, limited, thing the character is trying to accomplish at this moment in the play. What the character wants right now.

### *obstacle*

The specific, limited, thing, at this moment in the play, that prevents the character getting what he or she wants.

### *action*

The tactic the character takes, or the strategy the character uses to overcome his or her obstacle. Most often, it is the means by which the character tries to manipulate other characters into removing the obstacle to his or her objective.

Changes in emotion and purpose are what make acting (and therefore animation) interesting. Changes in dynamic are what make a play or a film interesting.

So when approaching a scene to animate, it's a good idea to divide that scene up into beats.

At each of these beats, you could think about what Laban type ‘efforts’ would be adopted by the character during each of these specific sections. (As always have the general efforts in mind for the specific character and then overlay the efforts appropriate for the emotion.) You could act out the scene first, dividing it up into beats and then taking video footage of yourself as reference. It’s also a good idea to discuss this performance with somebody else and get his or her opinion on it.

## personal space

People standing or sitting side by side who don’t know each other will acknowledge each other’s presence. It may not be obvious, but they will acknowledge each other subconsciously. We all have a concept of personal space. That is, we all have an area around ourselves that we consider ours and we only allow people that we are comfortable with into this space. Having said that, we like to feel accepted and to make other people feel accepted. Because of this we won’t sit or stand as far away as possible from others. When we sit on a park bench or in a train carriage we sit an acceptable distance away from those we don’t know. When in a queue we give each other room to feel comfortable. If we were too close it would make us feel very uncomfortable.

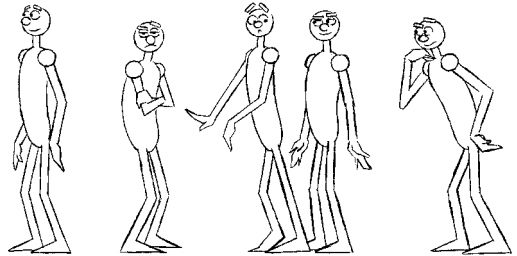

Having said this, there are situations when personal space has to be reduced. A good example is when we are crammed into a tiny space such as a full railway carriage. In this situation people tend to look upwards or shut their eyes in order to avoid eye contact.

One of the best places to observe this is on an underground train.

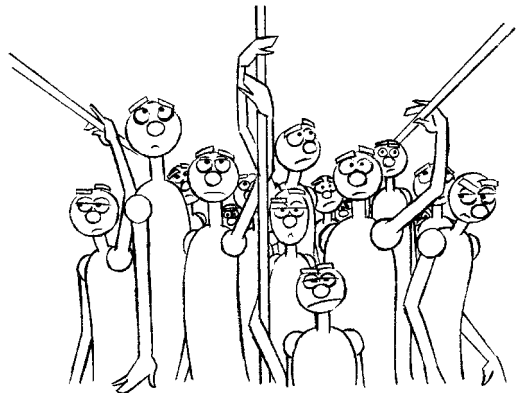

When two people know each other well they allow each other into their personal space. The degree to which you allow your characters into each other’s space gives an audience an idea of how familiar they are. Another indicator of this is the way your characters touch each other. If people are only acquaintances nothing should go beyond touching the outside edge of the arms and shoulders, or shaking hands. Often touching the outside edge of an arm is used when the person doing the touching wants something from the person being touched. This may be

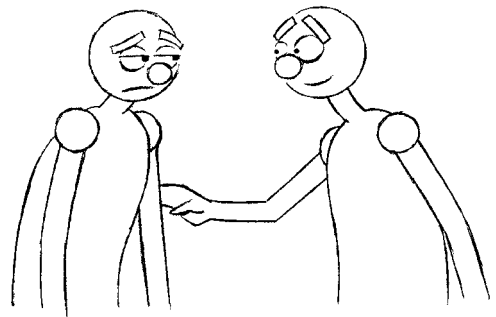

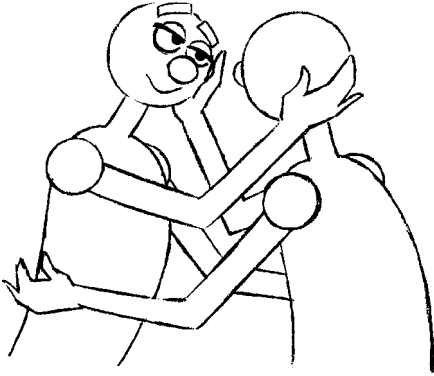

a favour or money or it could be to offer consolation, commiseration or reassurance.

People who know each other better can cuddle, touch the other person on the face, kiss, and touch hair or the outsides of the legs.

If your characters touch each other more intimately

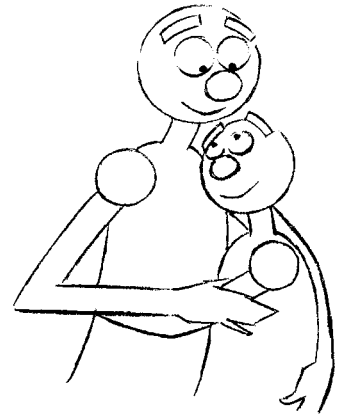

than this they are either lovers or closely related.

Of course very young children are unaware of these taboos and, in their innocence, move into other people's space freely.

When children reach their early teens (or earlier) they shy away from this sort of contact. They are in the process of learning their body language and become more self-conscious.

The concept of personal space is learnt and is different depending on differing cultures.

## mirroring

When two people know each other well and are in close proximity, for example; they are engaged in a conversation, they will mirror each other. This means that each character adopts body language that is similar to the other character. They may cross their legs in the same way, lean on their elbows on the table in the same way or angle their head in the same way. These are only a few examples of the many different ways in which your characters can mirror each other.

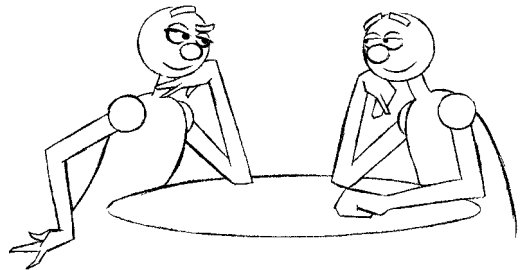

The amount that people mirror each other depends on how well they know the other person and also how well they want to know that person. The degree to which your characters mirror each other is an indication to the audience as to what sort of relationship they have. Two teenagers trying to look cool will adopt postures that suggest boredom together. An office junior trying to impress his boss will imitate his/her body language.

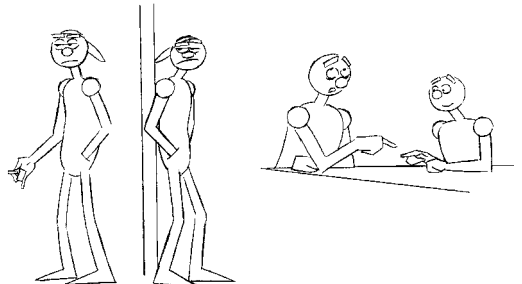

When a couple are on that oh so important first date, if they are attracted to one another they will end up mirroring the other person's behaviour. They will be trying so hard to mirror each other that their movements may seem forced. They will occasionally slip out of mirroring when they are distracted; for example, when a waiter asks whether everything is OK with their meal, and will act as themselves. To show to the other person that they are attracted, they have to learn to mirror them.

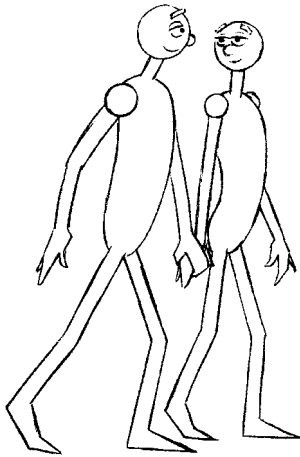

When a couple have known each other for a while they will mirror automatically and feel at ease in each other's company. Their body language will suggest that they are together to the rest of the world. They will hold hands or hug when they walk.

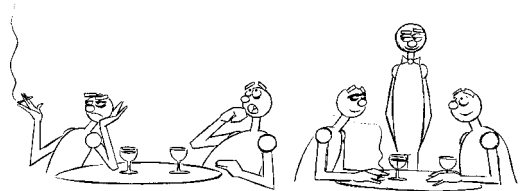

When two characters have been in a long-term relationship there may be a level of boredom with each other. As a result, they will try to reinforce their own identity. When together they tend to, almost deliberately, not mirror each other's body language. One may read a newspaper whilst the other is looking at their surroundings. They will deliberately occupy different poses. When interrupted they will start mirroring each other, because this is their natural state.

When mirroring, people will take drinks from their glasses at roughly the same time. They will take bites of their food at the same time. When walking along together their strides will synchronize.

## how characters look at each other

Again this all depends on how well the characters know each other and what their relationship is.

When two characters are in love they will stare directly into each other's eyes. Each character is essentially giving themselves to the other person and not covering anything up, and they will look at each other with a happy questioning look. Because each character is looking into the two eyes of the other person, their own eyes will swap from side to side. Both eyes focus on one eye and then on the other (make the eyes

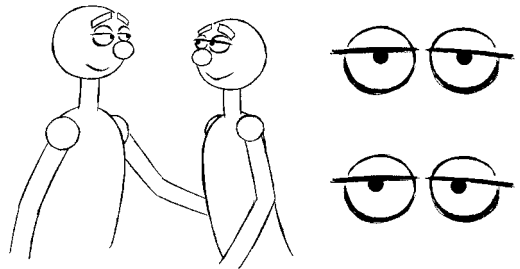

stay in one position for a second or so and then click the pupils to a second position, repeat at random). This gives a very open look. Combine this with an occasional slow eye blink and dilate the pupils.

When characters are staring at each other competitively, staring each other out, the eyes

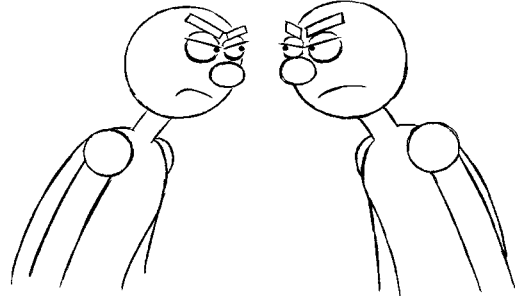
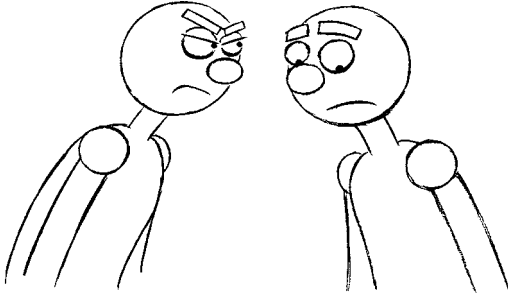

remain locked on one point of the others face (between the eyes). The eyes will not swap. Each character's eyes will blink as little as possible and the pupils will be contracted.

When two people don't know each other as well as lovers, their eyes will meet only for a short period of time. In some ways staring at somebody is an intrusion of their personal

space as much as grabbing hold of them is. The more confident person will maintain eye contact for longer.

When somebody is attracted to someone, a stare is a way of getting attention. Let's take the very stereotypical situation of a man and a woman who are attracted to each other. A woman will look at the man and when she gets a look back from him, will look away. If she is happy with the situation, she will steal a look back with the body and head facing away from the man. A man on the other hand will stare and continue staring at the woman. If he receives a positive reaction, it's time to walk over and introduce himself. If he receives a negative reaction it's time to try something else.

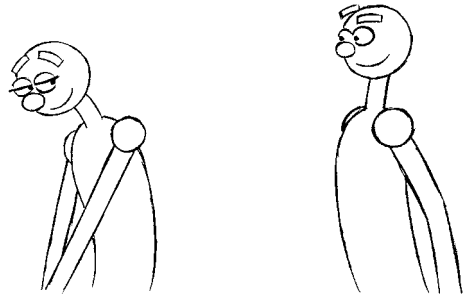

## two characters acting with each other while talking

When two characters are talking to each other, depending on what is being discussed, the character talking can often be highly animated. The speaker will look in different directions to emphasize a point and will

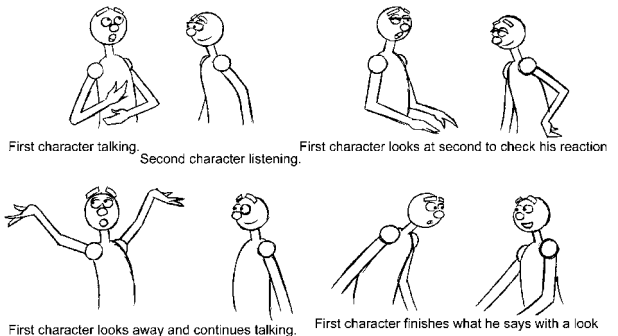

First character talking. Second character listening.

First character looks at second to check his reaction

First character looks away and continues talking.

First character finishes what he says with a look

occasionally look at the listener to check their reactions. The listener will be looking at the speaker (hopefully in rapt attention). When the speaker is finished, the person will look at the one listening. This signals to the listener that the speaker has finished and that a reply can be made. Having said this the person listening may want to say something further and will adopt a suitable body posture. The listener may try to interrupt the person talking. Both characters could end up talking at the same time.

Now the rolls are reversed. The second character talking, gesticulating and looking in different directions to emphasize different points and the first character will be doing the listening. Should the first character want to butt in when the second character is talking, they will stare more intently and may be on the edge of their seat. They may get the first couple of words of their statement out depending on how determinedly the other character is talking.

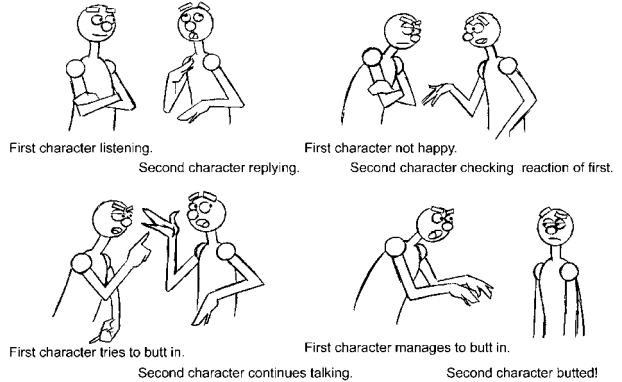

When two characters interact it has to be like a game of tennis. One character has the audience's attention then the other character.

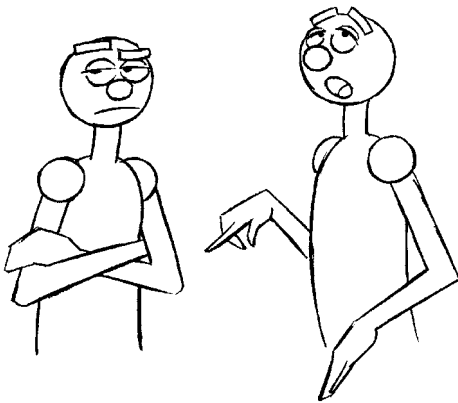

A bored listener who is trying to look attentive will stare rather too intently at the talker, but will occasionally find something else interesting and look away or stifle a yawn.

If the listener is bored the person will look up or away from the speaker. The person will yawn or do anything other than look engrossed at the talker.

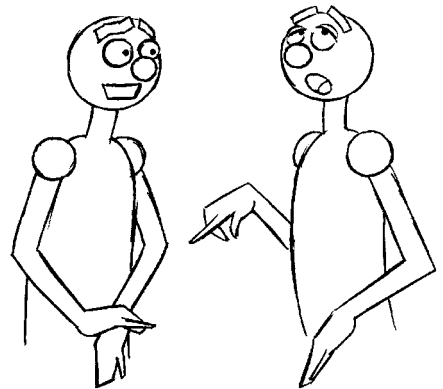

## two characters alternating from one shot to another

Having two characters acting in one scene is only used in animated film making occasionally (e.g. when there is physical contact between the two characters or when you need to see the two characters together). More often than not a basic film-making technique is used where we



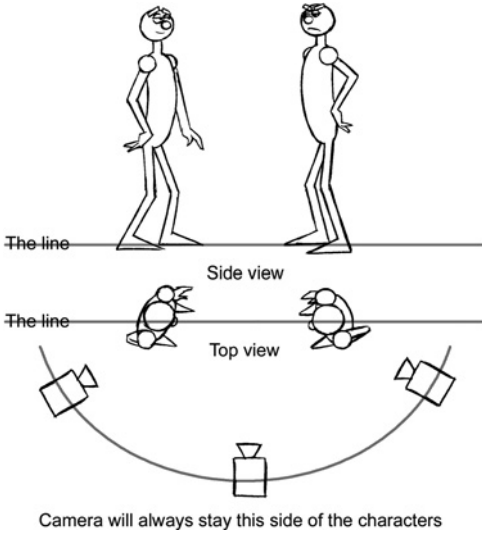

cut from one character to the other as the conversation or action continues.

The most important rule to learn is do not cross the line. Imagine that your characters are on stage together and the camera is the audience. Imagine a line running between each of these characters. The camera has to stay on one side of this line.

Start with an establishing shot that shows both of the characters. Follow with a close-up of the first character talking or acting. This will then be followed by a close-up of the second character replying.

When animating your characters in close-up we follow most of the techniques described earlier in this chapter. The difference being that only one character is on screen at a time. Always bear in

mind that your character is looking off screen at the other person. Depending on the relationship with the person off screen, the way your character looks at them will change.

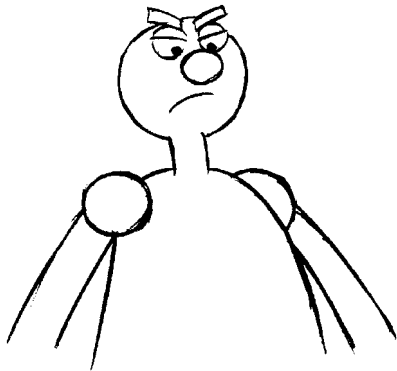
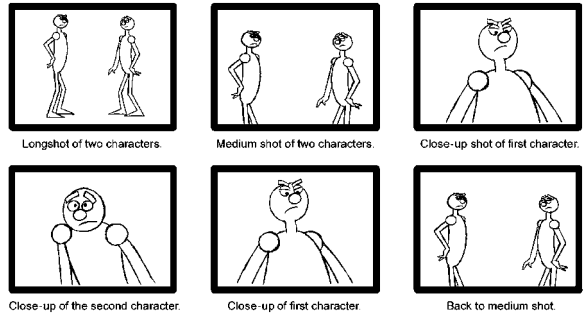

arrange the camera to look down on them.

To make a character look more dominant arrange the camera to look up at them.

To make a character look more submissive

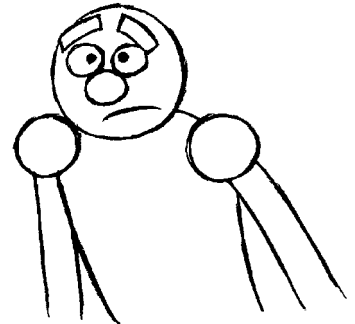

## a large group of characters on screen at the same time

With a large group of characters on screen at the same time the most important thing is to make sure that your audience is looking at the right character at the right time. This is done in a combination of ways.

Firstly using focus. If the main characters are in the foreground and the rest of the crowd is in the background, the background characters can be slightly out of focus.



Secondly, lighting and colour. If the background characters are slightly duller in colour or are lit more darkly than your main characters, the audience's eye will be drawn to the characters that matter.

Finally the main way to get your audience to look at the important characters is to make them more animated than the lesser characters. Don't move the background characters around too much because they will be too distracting. Any movement these characters make must be a down-played version of the movements they would do if they were the main characters in a scene.



If you watch any film (animated or live action), look at the characters in the background. They will move in a way that will not be distracting to the audience. In live action films there are a whole subsection of actors that do nothing other than be extras. It's as though the acting knob has been turned down. Many actors on their way up (and on their way down) get acting work playing these roles. In animated films this is where junior animators can cut their teeth, because the quality of animation required is not as great as that of the main characters.

## exercises

### *double acting in 2D*

Have two characters in a scene side by side. One of the characters has to attract the attention of the other. The other character reacts to this.

When animating two characters interacting with each other always animate the character that initiates the action first and then animate the character that reacts. Keep each of these characters on different pieces of paper. This means that if you need to change the timing of one of your characters you only have to re-draw that character.

Here are some ideas of what you could do.

## Situations...

Two people sat at a bar.

Two people standing at a bus stop.

Two characters sat at a park bench.

Two characters waiting in a queue.

Two characters having an arm wrestle.

What they could do...

Have the passive character occupied with something. Reading a book or newspaper, reading a poster, cleaning their glasses or listening to a Walkman. Have another character trying to get their attention.

One of the characters sees something off screen and tries to get the other character to look at it.

One character asks the other character for something, the time, some change, a match or the way.

## how to animate it

The first thing to do is write down what is going to happen in the scene. Then draw some thumbnail sketches and shoot them to get an idea of the timing. In this little scenario we have two characters on a park bench. The first character is using a pair of headphones. He switches them on and starts head nodding to the music. The second character hears the music and is disturbed by it. The second character gets more and more wound up by the sound and finally, through hand signals, asks if the first character can turn the music down.

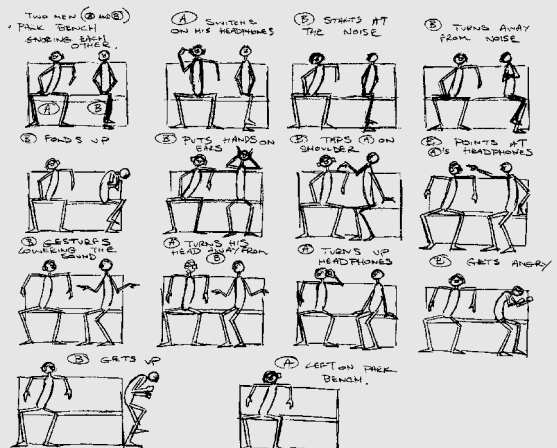
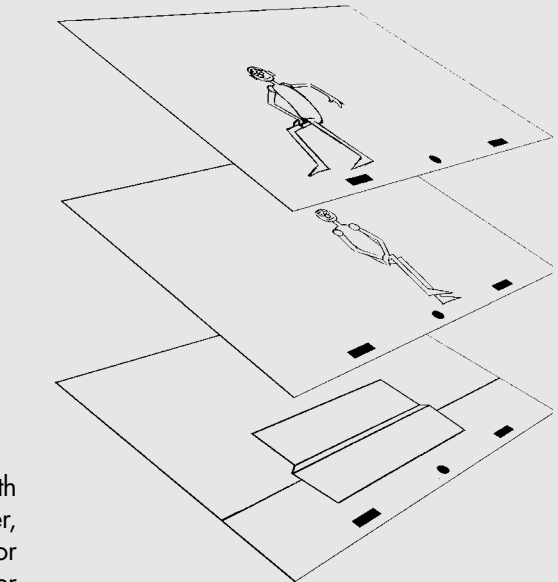

The first character looks at the second character gesticulating, gets bored and then looks away from the second character and turns the music up! The second character gets even angrier and storms out of scene. It's 450 frames (18 seconds long).

Take a look at 2\_act\_thumbs.avi in animations011, chapter011 of the CD-ROM.

Once this is sorted (and remember always to err on the side of being slightly too slow rather than too fast) draw the thumbnails full size or blow them up on a photocopier. Work out the key positions (the anticipations and overshoots, follow-through and what a character does when they are in a particular pose) but put each character on a separate sheet of paper. When working out the key positions start animating the character that initiates the action. In this case it's the character that has the headphones (the entire sequence of keys are on the CD-ROM).

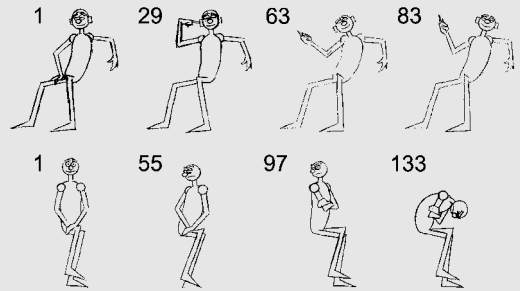

The first character switches on the headphones and starts head nodding to the music (the nodding of the head is a cycle). Have the second character make a small amount of movement.

When the first character starts head nodding to the music the action moves to the second character getting annoyed at the sound of the music (put one of the drawings of the first character on your light-box and work out the keys for the second character's reaction on separate paper). When the second character taps the first character on the arm the action passes back to the first character.

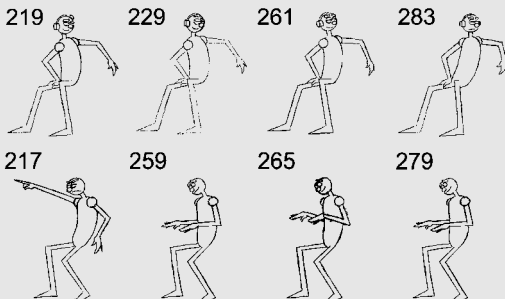
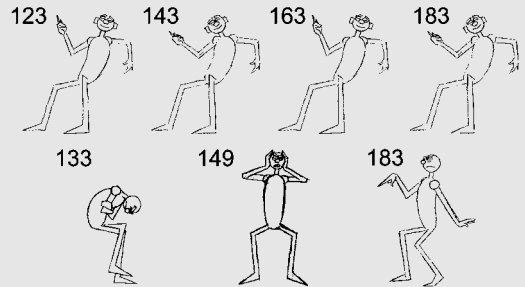

The action is with the first character who reacts to being tapped on the shoulder, but the action goes back to the second character who indicates turning the volume down.

As the second character makes this 'volume lowering' repetitive action the first character very deliberately turns away

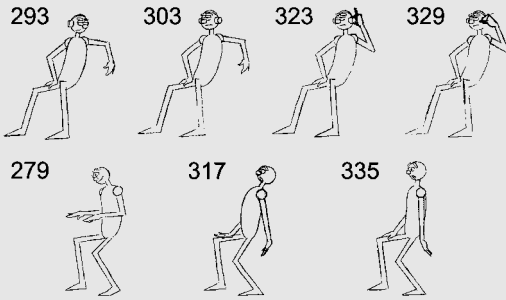

and then turns up the volume on the headphones.

Finally, have the second character look flabbergasted and then get angry and storm out as the first character continues head nodding to the music.

Mark up the drawings on an x-sheet, using three columns (one for the background, one for the first character and one for the second character). Test these key positions, adjust as necessary and work out the timing charts (there is a full copy of the x-sheet and all the keys on the CD-ROM).

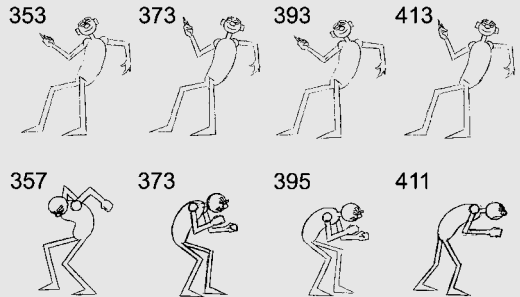

| SEQUENCE NO.                            | LENGTH: | SHEET NO. 1 of 9 |   |   |   |   |     |                       |
|---|---------|------------------|---|---|---|---|-----|-----------------------|
| HE ABHOVES MAN<br>STRESSED MAN<br>CHAIR |         |                  |   |   |   |   |     |                       |
| LEVELS:                                 |         |                  |   |   |   |   |     |                       |
| FRM NO                                  | 6       | 5                | 4 | 3 | 2 | 1 | B.G | CAMERA                |
| 1                                       |         |                  |   |   | 1 | 1 | BG  |                       |
| 2                                       |         |                  |   |   |   |   |     |                       |
| 3                                       |         |                  |   |   | 2 | 3 |     | 10 F 1 S OF<br>12 F F |
| 4                                       |         |                  |   |   |   |   |     |                       |
| 5                                       |         |                  |   |   | 3 | 5 |     |                       |
| 6                                       |         |                  |   |   |   |   |     |                       |
| 7                                       |         |                  |   |   | 7 | 7 |     |                       |
| 8                                       |         |                  |   |   |   |   |     |                       |
| 9                                       |         |                  |   |   | 9 | 9 |     |                       |
| 10                                      |         |                  |   |   |   |   |     |                       |

Take a look at 2\_act\_keys\_2D.avi in chapter011 of the CD-ROM.

Then in-between all the drawings by following the timing charts.

Take a look at 2\_act\_2D.avi in chapter011 of the CD-ROM.

### double acting in 3D

Load the character with the mouths and eyebrows onto your program from your C drive (or data folder in the case of XSI). (lightwave-man\_mouth.lws, xsiman\_mouth.scn, mayaman\_mouth.mb or maxman\_mouth.max).

Once the character is loaded you need to duplicate it (there are several ways to do this), so you have

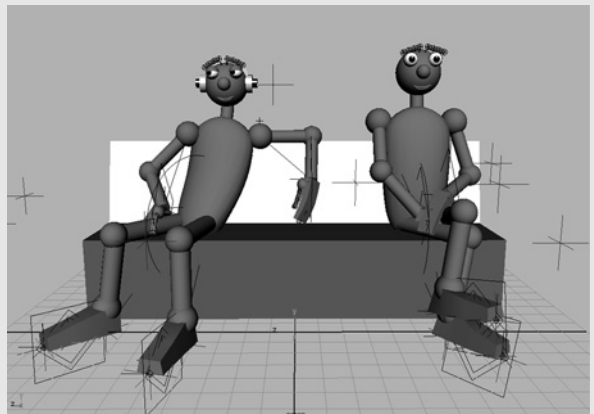

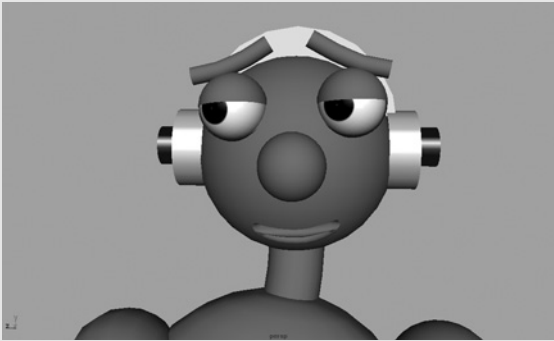

two characters that look exactly the same (you may want to change the colour of one). Then build a basic park bench out of simple cubes.

You will then need to make a pair of headphones for one of the characters. Build these out of several cylinders of varying depths and parent them all to the head bone so that they will move with the head.

## *how to load two identical characters into the same scene*

### **3D Studio Max**

In 3D Studio Max to get a second character open `maxman_mouth.max` and move your character over a bit. Then go to the main menu and left click `File > Merge...` and select the same scene; `maxman_mouth.max`. Up will come the Merge window. Left click All and OK. Up will come the Duplicate Name window. Tick the Apply to All Duplicates box and then left click the Merge button. You will now have a second character in your scene. Save this scene as `double_maxman_mouth.scn`.

### **SoftImage XSI**

Open `xsiman_mouth.scn`. Move it over a bit. Then go to the main menu and left click `File > Merge ...` and select the same scene. Left click OK and the same character will be loaded into scene. Save this scene as `double_xsiman_mouth.scn`.

### **maya**

Open up `mayaman_mouth.mb`. Move it over a bit. Then go to the main menu and left click `File > Import` and select the same `mayaman_mouth.mb` in the Import window. Left click the Import button and you should have a second character in your scene.

### **LightWave**

Load `lightwaveman.lws` into the scene. Move it over a bit. Then go to `File > Load > Load Items From Scene` and up will come the Load Items From Scene window. Select `lightwaveman.lws` and left click Open. With any luck you will have two characters in the scene.

With all the programs make a note of the new names that all the components have been renamed, so you don't get too confused.

Follow your drawn animation to the letter (or follow the first six illustrations in the 'How to animate it' section and the illustrations on the CD-ROM), working on one character first and then as the action passes to the second character work on that animation.

Take a look at 2\_act\_3D.avi in chapter011 of the CD-ROM.

## chapter 12

# lip-sync

- *recording and breaking down a dialogue track*
- *how we speak*
- *acting with dialogue*
- *quick from pose to pose*
- *slow from pose to pose*
- *erratically from pose to pose*
- *mouth shapes*
  - mouth shut consonants*
  - the vowels*
  - the quieter vowels and consonants*
  - animating the mouth shapes early*
- *exercises*
  - lip-sync in 2D*
  - lip-sync in 3D*
  - mouth shut consonants*
  - the vowels*
  - the quieter vowels and consonants*
  - animating the mouths*
- *creating a more sophisticated character's face and expression*
  - eyebrow movements*
  - mouth and jaw movements*
  - cheek movements*
  - nose movements*

### chapter summary



Many aspiring animators are slightly afraid of getting their characters to talk. They shouldn't be. Lip-sync is much easier than you think and, as long as you follow a few basic rules, the timing is sorted out for you. Rather than having to guess or rely on your experience to get the timing right, your timing is worked out from the dialogue that your character is speaking. The main thing to remember is that the quality of acting by your character is the most important part of lip-sync. The mouth shapes only make up a small part of a lip-sync scene. If the acting is good you can get away with murder when it comes to the mouth shapes.

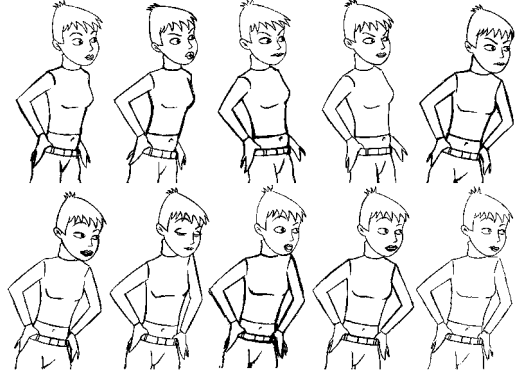

## recording and breaking down a dialogue track

In order to animate a piece of lip-sync it helps if you first record your dialogue (you can take advantage of the dialogue to help with your timing and characterization).

Record a piece of dialogue or take a section from a feature film, TV show, radio show or CD. You can even download .wav files from the Internet.

The simplest way to record your dialogue is to use the Sound Recorder on your PC. Go to the Start button, then go to Programs > Accessories > Entertainment > Sound Recorder and up will come the Sound Recorder window. Insert a cable between the audio out of a video recorder, midi-disk player, CD player or microphone into the microphone socket of your computer. Press play on your sound equipment and press the record button on the Sound Recorder. Save the sound as a .wav file.



The Sound Recorder does not give the best sound quality and you may want to try a specific sound recording program. There are lots of sound recording and editing programs available in either shareware or demo versions on the Internet. You may even have one with your sound card.

I've included two pieces of dialogue on the CD-ROM in the sounds folder in chapter012. They are called hello.wav and moment.wav.

Once you've got your dialogue, you need to break it down. That is, you need to work out frame by frame where each sound of your piece of dialogue occurs during the scene that you are animating. This then needs to be marked onto the sound column of an x-sheet.

DigiCel Flipbook can be used to break your sound track down. In fact any program that divides up your sound track into units of 25 frames per second (PAL) or 30 frames per second (NTSC) can be used.

It's best to record your dialogue in short pieces (the length of a scene, say, or one person talking) rather than your entire movie at once. This will give you more freedom when it comes to editing your movie.

Trim your dialogue to the correct length and save what you've recorded as a .wav file. If you downloaded your piece of dialogue from the Internet, you can miss out the information about recording.

Now open up DigiCel Flipbook and import your sound track onto an XSheet (right click on the word Sound on the XSheet and in the Sound Properties window click Change, find your .wav file and click OK; the sound will now be loaded into the sound column). Scrub through the sound slowly and mark onto a paper x-sheet the frames where each of the sounds of the dialogue start and end.

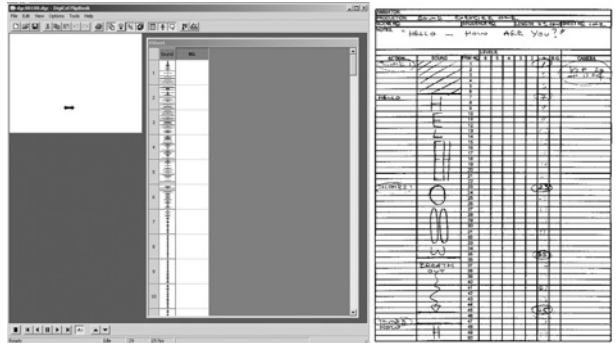

When breaking down a sound track I always play the dialogue through a few times and write what is said at the top of my paper x-sheet. When I'm scrubbing through the dialogue slowly the first thing I listen for are the silences. These occur between some words and where there are sounds produced by the mouth shut consonants. These are M, B, P, F and V. During speech these quiet sounds occur when the mouth is shut. Consequently little sound comes out of the mouth and the sound track is quiet or silent at these points.

Then I listen for the 'S' sounds in the dialogue. They tend to sound like a shhh or hissing sound. If the hissing sound lasts for 3 frames, mark it down on your x-sheet for 3 frames.

Keep scrubbing backwards and forward through your dialogue. The next sounds to listen for are T and C. T makes a tut kind of sound and C makes a kar sound.

Keep scrubbing backwards and forward through your dialogue. Listen out for the consonants at the start of each of the syllables of each of the words. Once these are done all that remain are the vowels. Listen for the loudest ones first. These will generally be the vowels that have the mouth wide open (jaw dropped). A and O are the loudest of the vowels. I and E tend to be quieter because the mouth is less open and less sound can come out of the mouth as a result.

## how we speak

Breaking down a sound track like this is a very good way to get an idea about how we speak.

In order to produce a noise out of our mouth the vocal cords in the throat vibrate. This causes air molecules to vibrate and they pass this vibration through millions of air molecules until they, in turn, cause your eardrum to vibrate. The information gathered by your eardrum is then passed to your brain.

The mouth can open and shut independently of the jaws, but to get the mouth as open as possible the jaw has to be dropped. The more open the mouth the louder the sound that could come out of the mouth.

Generally with most of the words that we speak there will be a consonant at the start of a syllable, and then a vowel (and often another consonant at the end). The consonant at the start gives shape to the sound and the vowel provides the power. So the mouth will usually be more open when it is speaking a vowel.

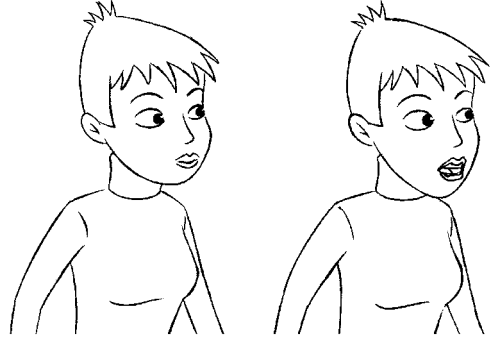

When we watch somebody speak we see a combination of the mouth opening into different shapes and the jaw opening and closing to augment these mouth shapes.

One way to work out where the jaw should open and close is to speak the piece of dialogue yourself while holding your index finger on the top of your nose and your thumb under your jaw. As you speak your thumb will be pushed down and up by your jaw.

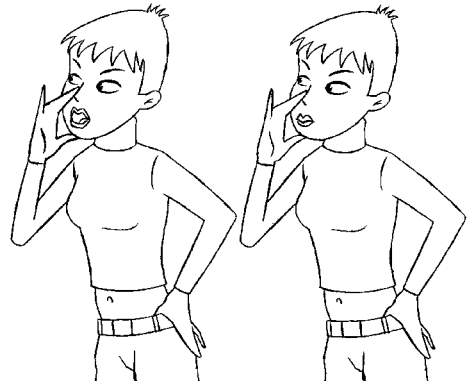

The most important mouth shapes are the mouth shut consonants. These are M, B, P, F and V. It's at these points, during speech, that only a small amount of sound (or none at all) will come out of the mouth. There will be a humming sound with M and B. No sound at all with P, all the sound comes as the mouth opens with a slight spitting noise. A slight escaping of air with F and a combination of a hum and escaping of air with V.

The reason why these mouth shapes are so important during speech is because they are highly noticeable to an audience. Before a mouth shut consonant occurs the mouth will usually be open and then shut quickly. After a mouth shut consonant the mouth will open quickly. Most other mouth shapes during a piece of dialogue will slur from one to the next. An audience uses these mouth shut consonants as markers to see if it is the person they are looking at who is talking.

When writers rewrite a script for a foreign language film that will be dubbed into English, they will write the script in such a way that mouth shut consonants will coincide in the script and with the mouth shapes being spoken by the characters on screen.

Generally we are quite lip lazy. That means that our lips don't accurately make mouth shapes but move from one shape to another. Unless you are animating something for effect with very exaggerated mouth shapes concentrate on hitting the mouth shut consonants and the large vowels. The rest of the mouth shapes can be regarded as in-betweens.

## acting with dialogue

When animating a scene with dialogue it's always best to leave the mouth shapes till last and concentrate on the body language and facial expressions first!

Listen to the dialogue over and over. It's probably best to do this with a Walkman. You'll drive everybody in the room crazy, playing the same track over and over.

Act out the dialogue as you play it on your Walkman. Watch yourself in a mirror. Listen to the piece of dialogue till you're sick of it. It's at this point that you start living it! You'll notice that there are certain words that are the main emphasis points. At each of these emphasis points, your character should be put into a suitable pose. This technique is called 'phrasing'. You can divide your animation up into major emphasis points and minor emphasis points. The major ones involve a movement of the body, the minor ones perhaps only involving a movement of the head.

Use the information in the last three chapters to work out the key poses that are appropriate for your dialogue.

If a character says, 'hello (pause) how are you?' the two major emphasis points are 'hello' and 'how'. The character could lean forward as he says 'hello' and then put the head to one side to say 'how are you?'. Within this movement you can put in a minor emphasis point on the '... you' at the end of the dialogue. So the head has been put on one side to say 'how are...' and then the head nods on '...you', while the body stays in the same position. There would also need to be small anticipation positions out of, and overshoot positions into, each of these poses (see the 2D animation exercise for a full description).

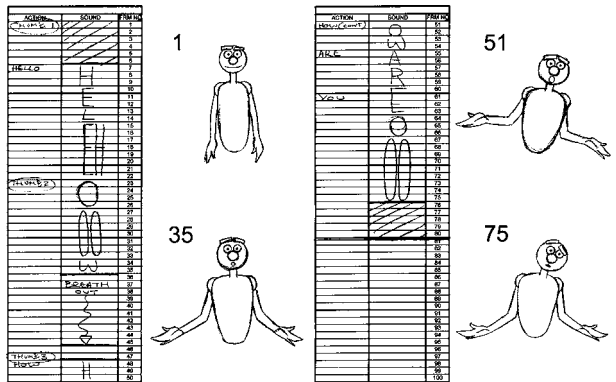

Don't try to put in too many of these emphasis point poses. At the most do about one a second. Any more than this and it will look as if your character is shaking far to violently.

Because your audience has to absorb far more information while watching a character talk, than with a mute character acting, you don't want to distract the audience with too much activity. The extremity of any poses depends on the character you are animating and the mood they are in. When your character is in one of the major emphasis poses you still have to give them something to do. Sometimes the minor emphasis points are enough; sometimes you have to put in a bit more.

When you've worked out your basic poses, shoot them on a line tester with the dialogue, giving them enough frames to take them to the next pose. How does it look? If some of the poses don't fit the dialogue, re-draw them and shoot them again. Are the poses hitting at the right time?

If the character is talking enthusiastically or aggressively, it might be best to hit the poses slightly early. About 2 to 4 frames early.

If your character is talking in a neutral manner hit the poses exactly at the same time as they say the phrase.

If your character is talking in a relaxed or hesitant manner hit the poses slightly late. About 2 to 4 frames late.

Don't try and be too clever about this. If in doubt hit the poses at the start of the word where the pose should start.

## quick from pose to pose

If a character is angry, excited, nervous or worried they will move quickly from one pose to another and will seethe in each of these poses.

## slow from pose to pose

If a character is calm, relaxed, happy or moody, sad or sulky they will move from one pose to another in a calm relaxed way.

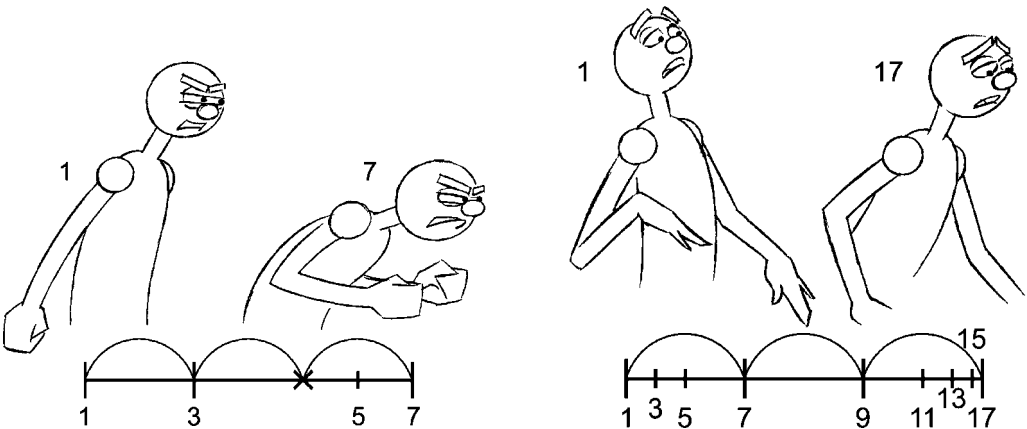

## erratically from pose to pose

This type of movement would be used when the mood of a character changes. For example; they may be talking calmly and then notice something that excites or angers them. They then start moving quickly from pose to pose.

How early or late that you hit these poses will give an indication of the mood of your character.

## mouth shapes

As mentioned before, we tend to be 'lip lazy' when we speak. This means that we slur the mouth from one shape to another and only define the mouth shut consonants. When we are communicating something precisely, we will clearly define each word.

It's always best to animate the mouth shapes last, on top of the animation of the body language and the facial expressions.

Remember that some mouth shapes have a jaw open. Generally, they are the loud vowel shapes A and O.

Also animate the mouth shapes straight ahead rather than key to key. This will give the lips a livelier look. As a guide, put in the mouth shut consonants first and then do the large vowels (these are where the jaw will be open). Always keep mouthing the words to yourself in a mirror.

### mouth shut consonants

Let's start with the most important mouth shapes, the mouth shut consonants. In order to make sure an audience sees these mouth shapes hold them for a frame longer than written on the x-sheet. In this case our character is saying 'moment'.

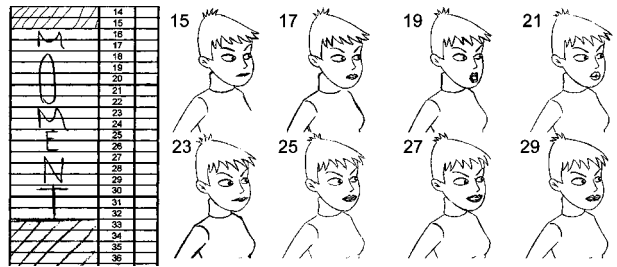

When animating into and out of these mouth shapes keep the previous mouth shape as one frame then go into the mouth shut consonant on the next frame (no in-betweens). When you get to the mouth shut consonant the lips will be placed together slightly differently depending on the sound.

Generally the jaw will be shut when your character is making the sound of a mouth shut consonant. If the sound after a mouth shut consonant has a jaw open the jaw can start opening while the lips are still shut in a mouth shut consonant shape.

### M

The lips are shut and a humming sound is produced. Both lips are tucked under against each other, wrapping over the teeth. When animating into and out of an M it tends to be slower than with B and P. It takes longer to un-tuck the lips from each other! At the start of your M mouth shape make the lips squash

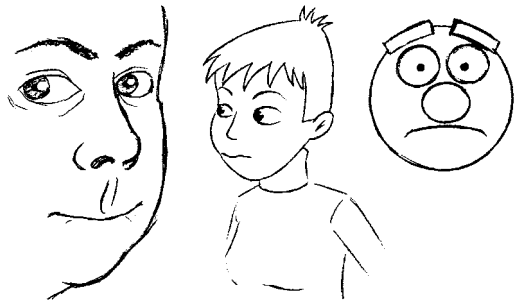

together. Towards the end of your M shape make a slight movement of the lips opening and then go straight into the next mouth shape.

## B

The lips are pressed together but not tucked under as much as with M. A humming sound is produced but at the front of the mouth rather than the back. When animating into a B shape create a small amount of squash in the mouth as it closes. When animating out of a B shape pop the mouth straight open.

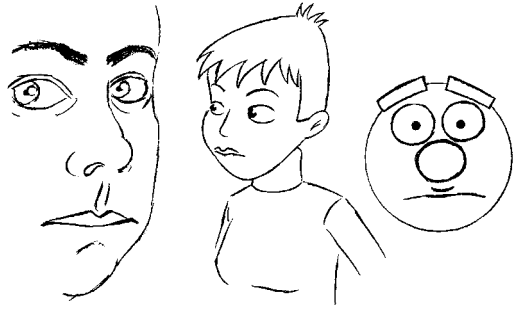

## P

With a P mouth shape the lips are squashed together and are pushed outwards. When animating into the P mouth shape move quickly from the previous mouth shape and then show the lips squashing outwards for the first part of the P. When animating out of the P shape, imagine you're trying to spit some grit off your lips. The mouth opens quickly with the lips pushing outwards and upwards. This jutted out lip position is reflected in the first frame of the next mouth shape.



## F

When the mouth is making an F sound, the bottom lip is tucked under and bitten by the teeth. Most of the sound comes from air hissing out from between the teeth and the lips. The shape of the top lip varies depending on the mood of your character. When happy or relaxed the top lip would be relaxed and almost covering the teeth. When angry or aggressive, the lip would be tensed up and pulled back to reveal the teeth; for example, when saying a naughty word. When animating into the next sound the teeth are raised and the bottom lip is flicked forward and downwards into the next mouth shape.



## V

As with F the bottom lip is tucked under the teeth but not as much. The sound made is a mixture of hissing air between the teeth and the lips and a humming sound. When animating out of a V sound the bottom lip doesn't pop out as far as with an F.

## the vowels

### OOO

The next most important mouth shape is OOO as in pool. This is because it takes the lips quite a long time to pull an OOO shape

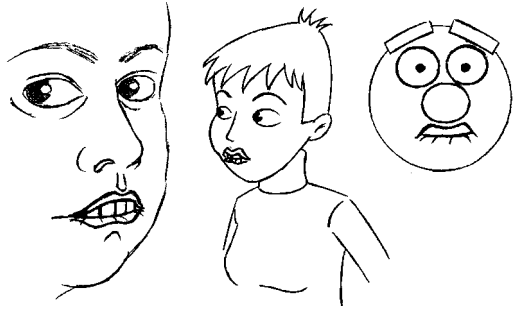

and then to pull out of it, so it's a mouth shape your audience notices.

The next most important mouth shapes are the loud vowels. These are the vowels that

produce the most noise and mean that the mouth should be widely open. For these the jaw should be dropped.

### O

O as in pot. A large oval shaped mouth with the jaw dropped.

### AR

AR as in car is like O but has a slight smile to it.

### A

A as in dad. This is a large but narrow smiling mouth shape.

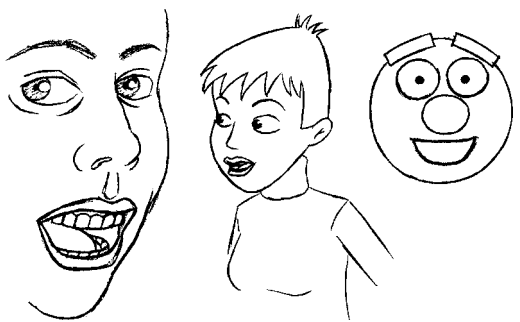
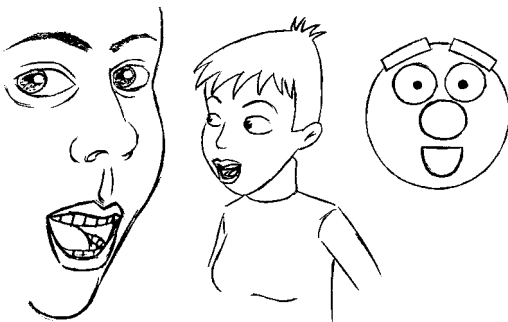



**EH**

EH as in wet. A large wide smiling mouth with the jaw dropped. Not quite as dropped as in O and A.

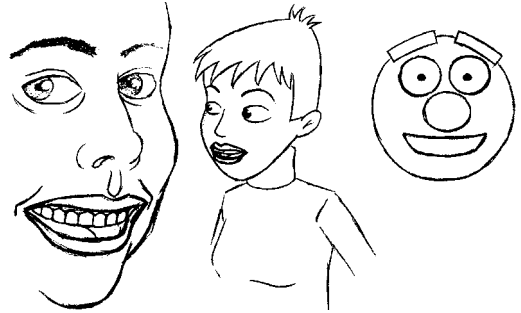

**EE**

EE as in squeeze is still quite loud but the jaw will not be as open as the other loud vowels. It consists of a wide smile.

*the quieter vowels and consonants*

The quieter vowels and the less defined consonants can be considered as in-between shapes that go between the mouth shut consonants and the loud vowels. The mouth shape can be almost any shape you like, the same sound will come out.

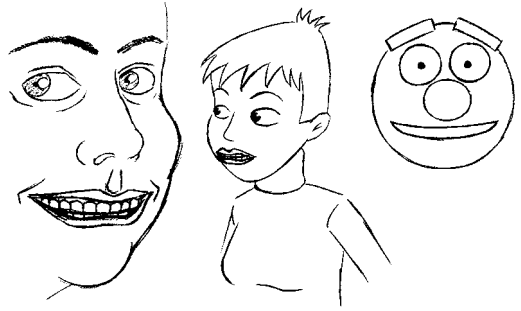

N, T, I, C, D, Y, Z, K, etc.

The other thing to remember is that a mouth shape will be influenced by the mouth shapes before and after it. For example, if you say the word 'moment' the first M mouth shape will be quite narrow with slightly pursed lips. The mouth then pops open into a larger O and then animates into a smaller OOOO shape. The mouth then shuts into another pursed lip M shape. This will animate over 2 frames to a wide M mouth shape which in turn pops open into a wide mouthed EEEE shape. The mouth will pop open slightly for one frame for the T and return to a wide mouthed EEEE.



This is why it's often better to animate mouth shapes straight ahead.

|   |    |
|---|----|
|   | 14 |
|   | 15 |
| M | 16 |
|   | 17 |
| O | 18 |
|   | 19 |
| O | 20 |
|   | 21 |
| O | 22 |
|   | 23 |
| O | 24 |
|   | 25 |
| M | 26 |
|   | 27 |
| E | 28 |
|   | 29 |
| E | 30 |
|   | 31 |
| E | 32 |
|   | 33 |
| E | 34 |
|   | 35 |
|   | 36 |

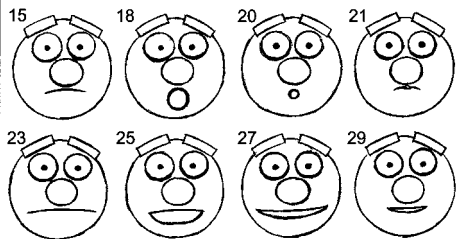

**teeth**

If your character has teeth, make sure your audience can see them in the majority of mouth shapes. Otherwise the teeth will keep flashing on and off and can be very distracting.

## animating the mouth shapes early

Sound travels slower than light. This means that you usually see something before you hear it.

Some animators will animate their mouth shapes one frame ahead of the sound. I've always come unstuck when I try to do this, so I animate with the mouth shape hitting the same point on the x-sheet as the dialogue breakdown. Later, if it doesn't appear to fit the dialogue or it looks better, I will slip the dialogue a frame later when I line-test the animation. Sometimes it works sometimes it doesn't. Again, don't try to be too clever with the animation until you have a lot of experience under your belt!

### exercises

#### *lip-sync in 2D*

Have a character act out one of the two pieces of dialogue that I have supplied on the CD-ROM. They are called *hello.wav* and *moment.wav* (you could always break down your own piece of dialogue and animate that!).

You will find copies of the x-sheets on the CD-ROM called *moment\_x\_sheet* and *hello\_x\_sheet*.

The two pieces of dialogue are 'hello...how are you?' and 'one moment...my good man'.

As always the first thing to do is to write down a list of character traits and then from that write down a list of what the character is going to do during the scene. Then work out a series of thumbnail sketches and shoot a pose test with them. With these you should have worked out the main emphasis points (or phrases) of the action.

For the piece of dialogue 'hello...how are you?' the main emphasis points are 'hello...' and 'how are you?'.

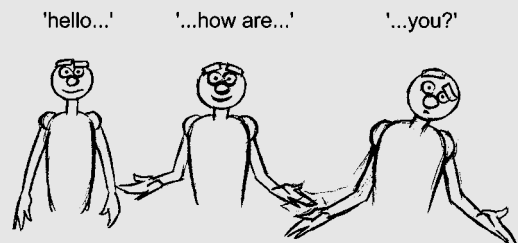

Notice that there are only three pose positions for the 80 frames of dialogue.

For the piece of dialogue 'one moment ... my good man', the main emphasis points are 'one moment...' and '...my good man'.

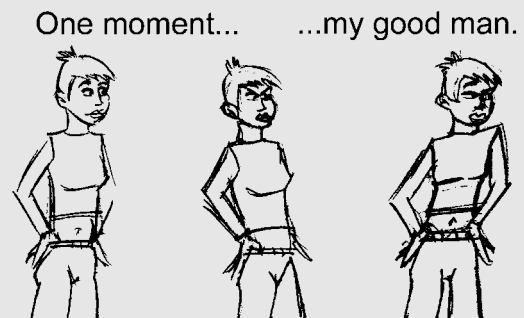

Take a look at *moment\_thumbs.avi* and *hello\_thumbs.avi* in chapter012 of the CD-ROM.

The next thing to do is to work out the key positions and the in-betweens, making sure the action fits the feel of the dialogue.

For 'hello...how are you?' we have the character anticipate backward and then lean forward on 'hell..'. The character then overshoots on the '..o..' and comes back to rest on the end of the '..o' sound (it's quite long). In the pause it anticipates its head to screen left and then leans its head to screen right on '...ho..' it will overshoot on the '..w..', then pull its head back again slightly on '..are..' and then put its head back down again for '..you', overshooting on the '..o..' and back up to rest on '..u'.

Take a look at hello\_keys\_2D.avi in chapter012 of the CD-ROM.

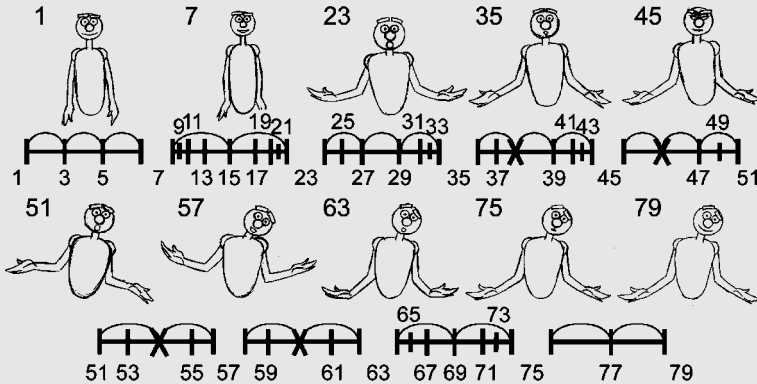

For 'one moment...my good man' (a good chance to do a lot of mouth shut consonants) the head goes down on 'one...' in anticipation of the arm coming up and the body leaning forward on the '...moment...'. Have the character overshoot its pointing hand and body on '..mo..' and settle down on '..ment..'. It can pull its hand back in anticipation on '..my..', then moving the hand forward on '..good..'. Overshoot on the '..m..' of '..man' and come back to rest on the '..an' of '..man'.

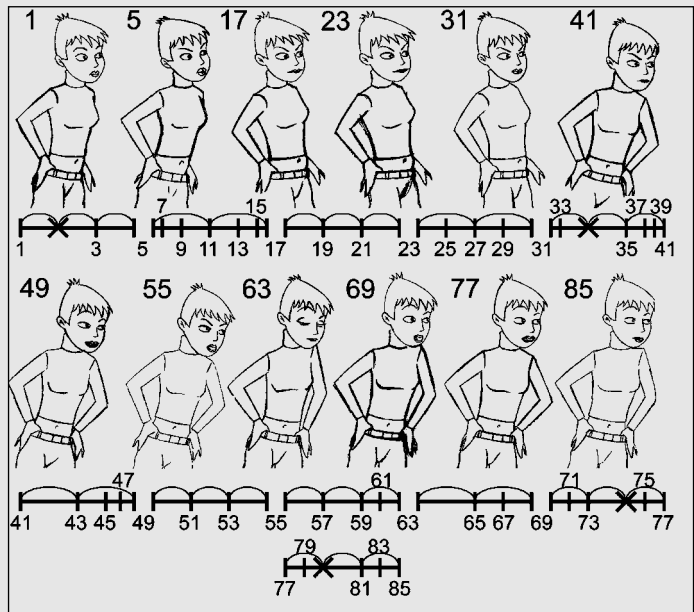

Take a look at moment\_keys\_2D.avi in chapter012 of the CD-ROM.

Finally, animate the mouth positions by drawing them onto the character's face one drawing at a time.

These could be animated straight ahead or you could work out where the mouth shut consonants are, then the ooo shapes, then the big vowels and finally all the other mouth shapes as in-betweens. Make the jaw open and shut on the big vowels. Line-test it to see if it is working. Experiment with slipping the sound up and down on the x-sheet (or by deleting or adding frames to the drawings).

Take a look at `moment_2D.avi` and `hello_2D.avi` in chapter012 of the CD-ROM.

### *lip-sync in 3D*

Load the character with the mouths and eyebrows onto your program from your C drive (or data folder in the case of XSI) (`lightwaveman_mouth.lws`, `xsiman_mouth.scn`, `mayaman_mouth.mb` or `maxman_mouth.max`).

By following your drawn animation (or the bottom illustration on p. 265 and top illustration on p. 266) and the x-sheet with the dialogue, work out the basic body language and facial expressions.

Take a look at `hello_keys_3D.avi` in chapter012 of the CD-ROM.

This shows the basic body language but without any mouth movement or breakdowns; it's letting the computer in-between the keys. Follow the timing charts in the top illustration on p. 266 to correct the way that our hero moves by adding keys at the breakdown positions.

Take a look at `hello_mouthless_3D.avi` in chapter012 of the CD-ROM.

This shows the body movement but there is still no mouth movement. If it's any good the body language should suggest the dialogue being spoken.

Once the acting is sorted out it's time to sort out the mouths. The basic mouth shapes can be made using the mouth shapes that come with the scene.

To get the various mouth shapes either use these mouth shapes as they are

(manipulate the tools in your program so that they are at 100%) or use mixtures of the



mouth shapes to get the desired mouth shape. The OH mouth shape is the basic shape with no distortion on it.

### *mouth shut consonants*

Use the mouth shape FVBPM.

### *the vowels*

**OOO**

OOO as in pool. Use mouth shape OOO.

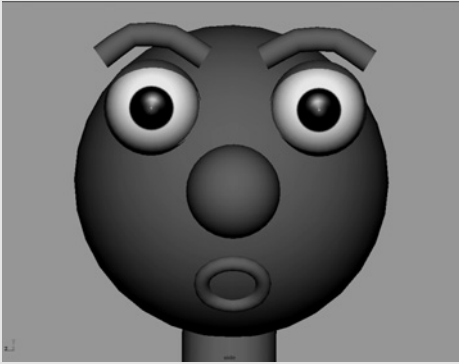

**O**

O as in pot. A large oval shaped mouth with the jaw dropped. Use mouth shape OH.

**AR**



**A**

A as in dad. A large but narrow smiling mouth shape. Have mouth shape BIG SMILE.

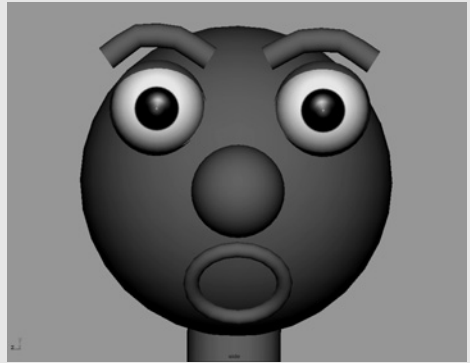
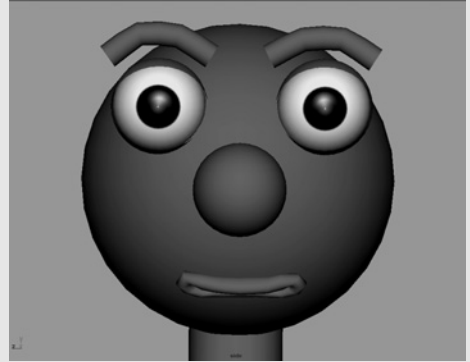

AR as in car is like O but has a slight smile to it. Use a mixture of OH and BIG SMILE.



**EH**

EH as in wet. A large wide smiling mouth with the jaw dropped. Not quite as dropped as in O and A. Mix OH with BIG SMILE but don't have the mouth as open as AR.

**EE**

EE as in squeeze is still quite loud but the jaw will not be as open as the other loud vowels. It consists of a wide smile. Have a mixture of BIG SMILE and SMILE.

### *the quieter vowels and consonants*

N, T, L, C, D, Y, Z, K, etc. Use almost any mouth shape you like as long as it in-betweens from one of the major mouth shapes to the next.

### *animating the mouths*

Change the shape of the mouth depending on the mouth shape required for the given sound on the x-sheet. Each of the four programs has a slightly different way of changing the mouth shapes and setting keys, so follow the individual instructions for each program in Chapter 10.

There is also the facility to import the sound into each program. Have a look at 3DSMax\_info, LightWave\_info, Maya\_info or XSI\_info in chapter001 of the CD-ROM.

Take a look at hello\_3D.avi to get an idea of what to do.

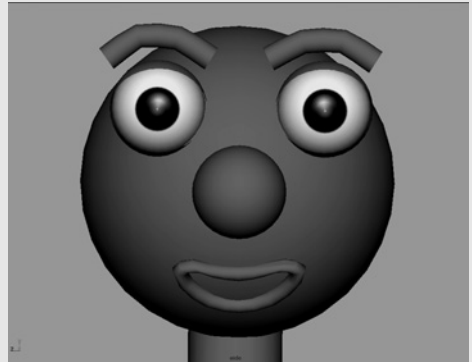

## **creating a more sophisticated character's face and expressions**

The main way to create convincing facial expressions on a 3D-animated character is to use shape animation. It's called different things in different programs but is essentially the same thing. You take your original model and copy it. Then you manipulate it so that it is pulling a different expression or pose and then this new shape can be made to affect the original face to a degree that can be saved as a key frame. The amount of these new face shapes that you create depends on how much work you want to put in. A basic character may have as few as eight characters in a feature film could have thousands.

When it comes to working out your characters facial expressions, first look at your script. If you are making a 30-second commercial which requires two facial expressions it would be silly to spend a huge amount of time creating hundreds of faces. Conversely if you don't create a face that you require, you are stuck!

You can divide the parts of the face down to, eyebrow movements, mouth and jaw movements, cheek movements and nose movements. If you assign a new face shape to each of these movements, you can keep the amounts of faces to a minimum. This will also make modelling and animation a lot simpler.

### *eyebrow movements*

Think of the eyebrows as being separate. Each brow should then be given these basic positions.

Brow neutral

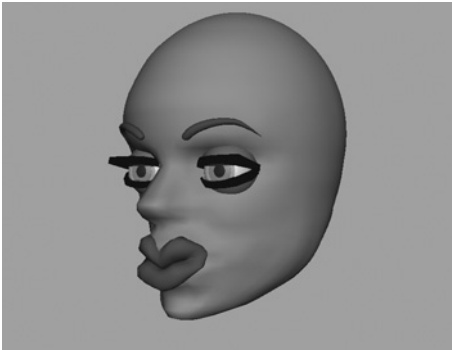

Brow raised

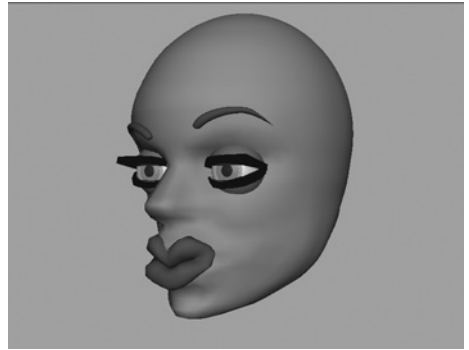

Brow lowered



Inner brow raised



Outer brow raised



### *mouth and jaw movements*

Just stick to something similar to the simple mouth shapes suggested for the face of the basic man supplied on the CD-ROM. These seem to cover most eventualities.

Neutral

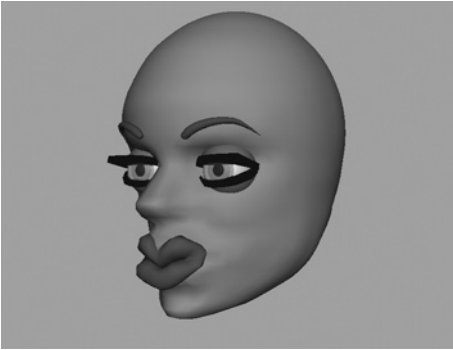

Smile

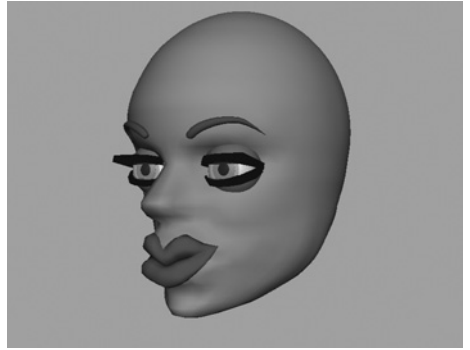

Frown

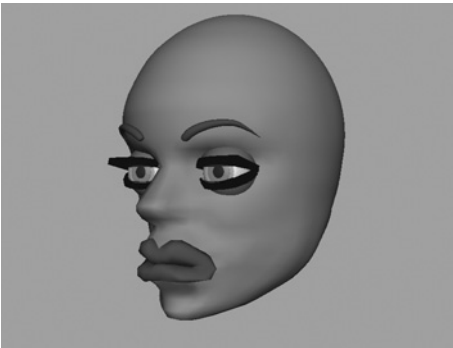

Big Smile





Big Frown

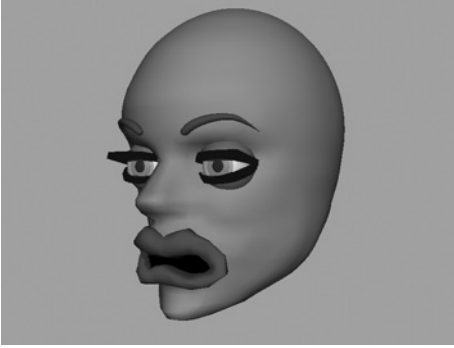

Oh



Ooo

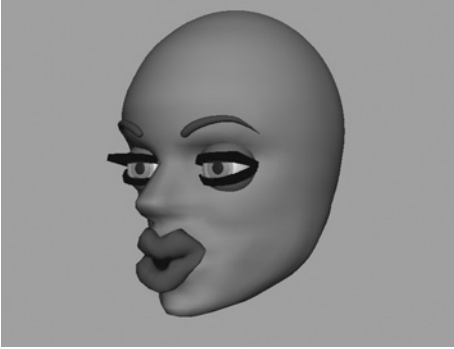

Anger

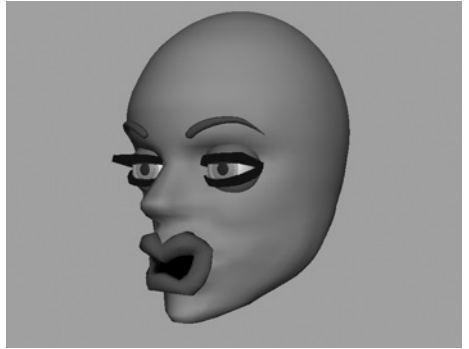

Yuk



FVBPM



Elvis

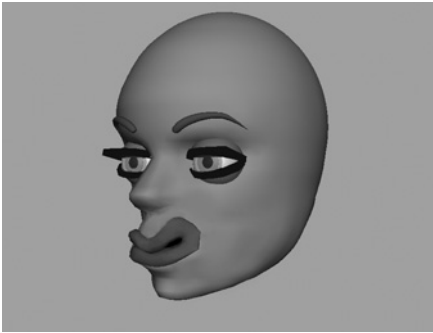

### *cheek movements*

During a smile the cheeks are raised.

Cheeks neutral

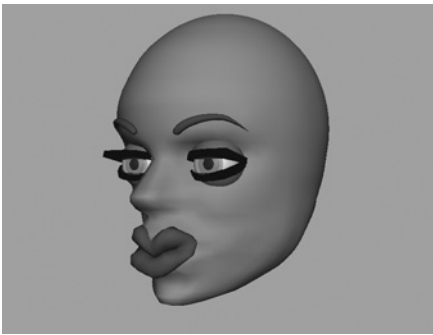

Cheeks raised



### *nose movements*

You can usually get away without any of these nose shapes at all but they can help some times.

Nose wrinkle



Nostril flare



It has to be emphasised that this is only one of the many ways that you can make the expressions of the face. I would always go along the route of greatest simplicity (at least to start with).

*This page intentionally left blank*

# index

- 3D Studio Max, 236–7, 253
- 'A' mouth shape, 263, 268
- Acting *see* Animation acting
- Acting out a scene, 195–7
- Action column, 5–6
- Alternating shots, 247–8
- Anal fins, 162
- Analysis of character, 203
- Anatomy, 49–54
- Anger, 123, 191, 192, 222–3
- Angle of head, 226
- Animals:
  - appendage follow-through, 98–9
  - birds, 170–7
  - cats, 145–6
  - construction, 137–40
  - dogs, 141–5, 152–7
  - elephants, 147–8
  - fish, 158–62, 164–9
  - horses, 137–8, 146–7, 148–51
  - running, 148–51, 154–7
  - snakes, 162–4, 168–9
  - walking, 136–48, 152–7
- Animated radio, 200–1
- Animating straight ahead, 13
- Animation acting, 178–213
  - acting out a scene, 195–7
  - anticipation, 190–6, 230, 231
  - basic efforts, 195–7
  - character beat, 265
  - character building, 228–32
  - consequence, 180–1
  - emotions, 181
  - facial expressions, 214–40
  - flow continuums, 183
  - full, 201–2
  - kinesphere, 182–3
  - Laban Movement Theory, 182, 183
  - limited, 200–1
  - method acting, 179–80
  - mime, 202–3
  - pose-to-pose, 201
  - questions of character, 199–200
  - space, 183
  - theatrical acting, 180
  - time, 183
  - two or more characters, 241–54
  - video footage, 198–9
  - weight, 183
- Animation curves, 24, 76
- Animation Mixer (SoftImage XSI), 237
- Animation paper, 3, 14
- Anticipation, 90–6, 230, 231
- 'AR' mouth shape, 263, 268
- Arcs, 54
- Arms, 100–1, 120, 193–4
- Attraction, staring, 246
- 'B' mouth shape, 262
- Back body postures, 187
- Background characters, 249
- Background level, 37
- Balance, 57, 58–9, 63–8
- Ball-and-socket joints, 53
- Ball bouncing exercise, 19–24
- Balloons, 33–5, 44–5
- Balls:
  - beach ball, 43
  - bouncy ball, 19–24, 37–41, 45–7
  - bowling ball, 31–2, 37–41
  - lift, 63–8
  - ping-pong ball, 44
  - soccer ball, 32, 41–3
- Basic human character design, 55–9
- Beach ball, 43
- Beats, 242–3
  - action, 242–3
  - objective, 242
  - obstacle, 242
- Birds, 170–7
- Blend Shapes (Maya), 236

- Blinking, 218  
 Blur, 101, 172–3  
 Body:  
   body language, 178–213  
   facial movement, 230–1  
   human anatomy, 49–54  
   movement in walking, 120–1  
 BodyControl, 155, 177  
 Bones, 49–54, 177  
   *see also* Skeletons  
 Boredom, 224, 227  
 Bouncy ball, 19–24, 37–41, 45–7  
 Bowling ball, 31–2, 37–41  
 Brain, left/right, 62  
 Breakdown drawings, 15, 16, 107, 108, 173, 175–7  
 Burst swimmers (fish), 160  
 Butting in (conversation), 247
- Camera column, 8–9  
 Cantering, 149–51  
 Cartoon four-legged walks, 139–40  
 Cats, 145–6  
 Catwalk model walk, 127–8  
 Caudal fin, 161  
 Cel, 8  
 Centre of gravity, 58  
 Characters:  
   analysis, 203  
   building, 228–33  
   construction, 48–80  
   design of basic human, 55–9  
   groups, 248–9  
   questions, 199–200  
   two characters, 241–54  
 Children, 244  
 'Children' (hierarchies), 46  
 Chinagraph pencils, 47  
 Close-ups, 228  
 Closed body postures, 187, 191  
 Cloven feet, 146  
 Colour for emphasis, 249  
 Columns, x-sheets, 4–9  
 Combative postures, 191  
 Competitive stare, 246  
 Complexity of characters, 56  
 Concertina movement (snakes), 163  
 Condylod joints, 54  
 Consequence, 180–1  
 Consonants, 258, 261, 264, 269
- Construction process, 30, 137–40  
 Contempt, 223  
 Cool walk, 125  
 Correct four-legged animal construction, 140  
 Couples' behaviour, 245  
 Crossed arms, 193–4  
 Crossed legs, 194–5  
 Crossover key positions, 117, 130, 142  
 Crotaline movement (snakes), 163  
 Cruisers (fish), 160  
 Curves, 24, 76
- Dabbing, 184  
 Daily life observations, 89  
 Deceit gestures, 227  
 Defiant postures, 191  
 Depressed mood, 121, 186–7, 190  
 Determined walk, 123  
 Dialogue, 256–7, 259–60  
 DigiCel Flipbook program, 10, 19, 20, 21  
   bowling ball animation, 37, 41  
   dialogue, 223–4  
 Disgust, 223  
 Dishonesty, 192  
 Displeasure, 194  
 Distress, 224  
 Dive exercise, 105–12  
 Dogs, 141–5, 152–7  
 Dorsal fins, 162  
 Double bounce walk, 126  
 Double takes, 93  
 Doubles *see* Two characters  
 Drag (fish), 159  
 Drawing skills, 25–7  
 Dreamy walk, 125  
 Drops of liquid, 35
- Eagerness, 188, 192  
 Early animation, 265  
 Ears, 99  
 'EE' mouth shape, 264, 269  
 'EH' mouth shape, 264, 269  
 Eight basic emotions, 216  
 Elbows, 120  
 Elephants, 147  
 Emotions, 181, 215–17  
   *see also* Mood  
 Emphasis points in dialogue, 259  
 Environment, 30  
 Equipment, 3–11

- Erratic pose-to-pose movement, 260  
Evaluation gestures, 227  
Exercises:  
  animation of acting, 203–8  
  bird flying on the spot, 173, 175–7  
  bird flying through the air, 174, 177  
  bird model, 174–5  
  bouncy ball, 19–24, 37  
  dive, 105–12  
  dog walk cycle, 152–7  
  double acting, 249–54  
  facial expression, 232–6  
  fish, 164–8  
  lift, 63–71  
  lip-sync, 265–9  
  pull, 77–80  
  push, 71–7  
  snake, 168–9  
  string and stick, 103–5  
  walk or run cycle, 132  
Expressions *see* Facial expressions  
External influences on walking, 128  
Extreme close-ups, 228  
Eyebrows, 234, 235, 238  
Eyelash fluttering, 218–19  
Eyes, 217–19, 245–6  
  
'F' mouth shape, 262  
Facial expressions, 214–40, 269–73  
  anger, 222–3  
  animation acting, 228–32  
  bones method, 234  
  boredom, 224  
  cheek movements, 273  
  combinations, 225  
  disgust/contempt, 223  
  exercises, 232–8  
  extreme close-ups, 228  
  eyebrow movements, 270–1  
  eyes, 217–19  
  fear, 222  
  hand-to-face gestures, 226–8  
  happiness, 219  
  head angle, 225, 226  
  interest, 223–4  
  mouth and jaw movements, 271–3  
  nose movements, 273  
  pain, 224  
  sadness, 220–1  
  surprise, 221–2  
  
False expressions, 216–17, 220, 221, 222, 223  
Familiarity, 243–6  
Fear, 222  
Feet, 140–1, 146–8  
Field-guides, 9  
Finger pointing, 102, 191  
Fins, 161–2, 165  
First dates, 245  
Fish, 158–62, 164–8  
Flat feet, 147–8  
Flatfish, 161  
Flicking, 13, 14–17, 196  
Flipping, 13–14  
Floating, 184  
Flow continuums, 183  
Flying, 170–7  
Focus emphasis, 249  
Follow-through:  
  animate objects, 98–101  
  ears, 99  
  hair, 99  
  inanimate objects, 97–8  
  limbs, 100–1  
Force, 30  
Forward body postures, 187, 188–9, 191  
Four-legged animals:  
  cats, 145–6  
  construction, 137–40  
  dogs, 141–5, 152–7  
  elephants, 147–8  
  horses, 137–8, 146–7, 148–50  
Frame numbers column, 6–8  
Frames per second, 2  
Frameslider, 23  
Fugitive postures, 190–1  
Full animation acting, 201–2  
Function Curves, 24  
  
Gallops, 150–1  
Gestures, 192–5, 226–8  
Gliding, 184  
Graphic nature of characters, 56–7  
Gravity, 57–8  
Groups of characters, 248–9  
  
Hair, 99, 102  
Hand gestures, 192–3  
Hand-to-face gestures, 226–8  
Handholding, 245

- Happiness, 123, 219–20  
 Head angle, 226  
 Head movement, 102  
 Headphones, 250–3  
 'Hello...how are you', 265, 266  
 Hierarchies, 45–6  
 Hinge joints, 53  
 Hips, 117, 143  
 Hooves, 146–7  
 Horses, 137–8, 146–7, 148–50  
 How this book works, 19  
 Human anatomy, 49–54  
 Hummingbirds, 172–3
- In-betweens, 66–8, 74–5, 79, 197  
 Inanimate objects, 28–47
  - balloons, 33–5, 44–5
  - beach ball, 43
  - bouncy ball, 19–24, 37–41, 45–7
  - bowling ball, 31–2, 37–41
  - definition, 29–30
  - follow-through, 97–8
  - liquids, 35–6
  - ping-pong ball, 44
  - soccer balls, 32–3, 41–3
  - water-filled balloons, 33–5, 44–5
- Insects, 172–3  
 Interest, 223–4
- Jaw movement, 258  
 Joints, 52–4  
 Jumping, 90, 92, 102
- Key positions:
  - bouncy ball, 46–7
  - bowling ball animation, 39
  - dive, 105–9, 109–12
  - dog walk, 141–5
  - facial expressions, 229
  - fish swimming, 166
  - flying birds, 171
  - good timing, 88
  - human running, 129–30
  - lift, 64–6, 70
  - pantomime horse, 137
  - pull, 78–9
  - push, 71–4, 76
  - scene animations, 196–7
  - string and stick, 104–5
- Key-to-key animation, 11–12  
 Kinesphere, 182–3
- Laban Movement Theory, 182, 183  
 Large groups of characters, 248–9  
 Left-hand side of brain, 62  
 Legs, 140–1, 194–5
  - see also Running; Walking
- Levels column, 8  
 Life drawing, 26  
 Lift, 63–71  
 Light boxes, 4  
 Lighting emphasis, 249  
 LightWave, 238, 253–4  
 Limbs, 100–1, 113–35, 193–5  
 Limited animation, 200–1  
 Line testers, 9–10, 18–19, 56  
 Line thickness, 228  
 Lip laziness, 259  
 Lip-sync, 255–74
  - acting with dialogue, 259–60
  - exercises, 265–9
  - how we speak, 257–9
  - mouth shapes, 261–4
- Liquids, 33–6, 44–5  
 Listening, 189, 191, 193, 247  
 Looking at each other, 245–6  
 Love, eyes, 245–6  
 Lying, 185, 216, 227
  - see also False expressions
- 'M' mouth shape, 261–2  
 Macho walk, 126  
 'Major emphasis poses', 259–60  
 Materials for 2D studio, 3–11  
 Matter animation, 28–47, 96–8  
 Maya, 234, 236, 253  
 Mechanics of walking, 116–21  
 Method acting, 179–80  
 Mime, 202–3  
 Mirroring, 129, 244–5  
 Mirrors, 88–9, 195  
 Model walk, 127–8  
 Mood, 121–8, 133–5
  - see also Emotions
  - angry, 123, 192, 222–3
  - depressed, 121, 186, 191, 220–1
  - happy, 123, 219–20
  - walking style, 121–8, 133–5

- Morph Targets (Lightwave), 238  
 Morpher (3D Studio Max), 236–7  
 Morphing method, 234  
 Motion blur, 101, 172–3  
 Mouth, 262–3  
   animation, 235, 236–7  
   cover gesture, 227  
   lip-sync, 255–73  
   mouth shut consonants, 261  
   shapes, 258, 267–9  
 Movement:  
   see *also* Running; Walking  
   anticipation during, 94–5  
   in arcs, 54  
   between poses, 260  
   blur, 101, 172  
   facial expression, 231
- Negative acting, 180  
 Not so clever walk, 122  
 Nurbs patch modelling, 231–2
- ‘O’ mouth shape, 263, 268–9  
 Object falling into water, 36  
 ‘One moment....my good man’, 265–7  
 ‘OOO’ mouth shape, 263, 268–9  
 Open body postures, 186, 188  
 Overlapping action, 101–2  
 Overshoot, 101–2, 230, 231
- ‘P’ mouth shape, 262  
 Pace of walking, 115, 133–5  
 Pain, 224  
 Palm gestures, 192  
 Pantomime horse, 137–8  
 Paper, 3, 14  
 ‘Parents’ (hierarchies), 46  
 Park bench doubles, 250–2  
 Paws, 140–1  
 Pectoral fins, 162, 165  
 Peg bars, 3–4, 14–15, 17  
 Pelvic fins, 162  
 Pelvic girdle, 51  
 Pencils, 11  
 Personal space, 243–4  
 Ping-pong ball, 44–5  
 Pitch and roll, 162  
 Pivot joints, 52–3  
 Plane joints, 53  
 Planning a scene, 61–2
- Pointing a finger, 102, 191  
 Pose tests, 18  
 Pose-to-pose animation acting, 201  
 Poses, acting with dialogue, 259–60  
 Postures:  
   basic, 186–7  
   combative, 191  
   fugitive, 190–1  
   reflective, 189  
   responsive, 187–9  
 Pressing, 183  
 Pull, 77–80  
 Pupil size, 217, 224  
 Puppets, 185  
 Push, 71–7
- Quick pose-to-pose movement, 260  
 Quiet walk, 124  
 Quieter vowels/consonants, 264, 269
- Rays (fish), 161  
 Recording dialogue tracks, 256–7  
 Reflective postures, 189  
 Rejecting postures, 191  
 Responsive postures, 187–9  
 Ribcages, 50, 145–6, 162  
 Right-hand side of brain, 62  
 Roll and pitch, 162  
 Rolling, 13, 17–18  
 Rotary gallops, 151  
 Running:  
   animals, 148–51, 154–5  
   dog, 154–5  
   exercises, 132–3  
   human, 129–31  
   walking cycle, 129
- Saddle joints, 53  
 Sadness, 121–2, 186, 190, 220–1  
 Scenes, 61–2, 195–7  
 Shoaling (fish), 160–1  
 Shot alternation, 247–8  
 Shoulders, 51–2, 116, 118–19, 143, 144  
 Sidewinder movement (snakes), 163–4  
 Silhouettes, strong, 57, 195  
 Simple character construction, 48–86  
 Sinusoidal waves, 159, 161  
 Skeletons, 49, 159, 162, 170  
 Sketching skills, 25–7  
 Skilled drawing, 25–7



- Skipping, 184  
 Skulls, 51, 159  
 Slashing, 184  
 Slow pose-to-pose movement, 260  
 Smearing, 101  
 Smiles, 219–20  
 Snakes, 162–4, 168–9  
 Soccer balls, 32–3, 41–3  
 SoftImage, 237, 253  
 Solidity, 30  
 Sound column, 4–5  
 Sound Recorder, 256  
 Space, 195  
 Speaking *see* Lip-sync  
 Special effects, 96  
 Speed, 12, 94, 101, 172–3  
 Spine, 50  
 Splashes, 36, 108  
 Splines, 24  
 Stability, 58–9  
 Stanislavsky, Konstatin, 180  
 Staring, 246  
 Straight-ahead animation, 13, 14, 104, 195, 201–2  
 Straight-on face to camera, 225  
 Strasberg, Lee, 180  
 Stress, 228  
 Stride positions, 116–17, 143–5  
 String and stick exercise, 103–5  
 Strong silhouettes, 57, 195  
 Studio equipment, 3–11  
 Suppliers of animation equipment, 3–4  
 Surprise, 94, 221–2  
 Swimming fish, 158–62, 164–9  
  
 Tails, 98–9, 172  
 Talking, 246–7, 255–69  
     *see also* Lip-sync  
 Teeth, 264  
 Theatrical acting, 180  
 Thinking gestures, 227  
 Three-dimensional animation:  
     animation acting, 207  
     bird flying on the spot, 175–7  
     bird flying through the air, 177  
     bouncy ball, 45–7  
     building skin and bones, 90  
     child of the joint, 81–3  
     creating body parts, 83  
     design, 59–61  
     dive, 109–12  
     dog walk cycle, 153–7  
     facial expression, 233–8  
     fish, 165–8  
     lift, 68–71  
     lip-sync, 267–9  
     pull, 79–80  
     push, 75–7  
     putting bones in man, 83–4  
     setting up eye controls, 85  
     setting up the legs, 85–6  
     snake, 169  
     string and stick, 105  
     two characters, 252–4  
     walk or run cycle, 132–5  
 Three-dimensional character, 238  
     eyebrows, 239  
     mouth, 239–40  
 Thrusting, 184  
 Thumb-sheets, 61–2  
 Thumbnail sketches, 89, 196, 203–8, 229, 230  
 Thumbs, 193  
 Time, 183  
 Timeslider, 23  
 Timing, 88–9, 202  
 Timing charts, 39–40, 42–3  
 Tiptoe walk, 124  
 Touching, 243–4  
 Trotting, 148–9  
 ‘Twining’, 195–6  
 Two characters, 241–8  
     2D exercise, 249–52  
     3D exercise, 252–4  
     acting and talking, 246–7  
     alternating from one shot to another, 247–8  
     interaction, 241–2  
     looking at each other, 245–6  
     mirroring, 244–5  
     personal space, 243–4  
     walking together, 129  
 Two-dimensional animation:  
     animation acting, 203–7  
     beach ball, 43  
     bird flying on the spot, 173  
     bird flying through the air, 174  
     bouncy ball, 37  
     bowling ball, 37–41  
     dive, 105–9  
     dog walk cycle, 152  
     double acting, 249–52

- equipment, 3–11
  - facial expression, 232–3
  - fish, 164–5
  - flicking, 13, 14–17
  - flipping, 13–14
  - frames per second, 2
  - how it works, 2
  - key to key, 11–12
  - lift, 63–8
  - line testers, 18–19
  - lip-sync, 265–7
  - materials/equipment, 3–11
  - ping-pong ball, 44
  - pull, 77–9
  - push, 71–5
  - relating to 3D animation, 22–4
  - rolling, 13, 17–18
  - snake, 168–9
  - soccer ball, 41–3
  - string and stick, 103–5
  - walk or run cycle, 132, 133–4
  - water-filled balloon, 44–5
  - working practice, 1–27
- Undulation (snakes), 162–4
- Up and down body movement, 120–1
- 'V' mouth shape, 262
- Vertebrae, 50
- Vibration, 103
- Video footage, 198–9
- Vowels, 263–4, 264
- Walking:
- animals, 136–48, 152–7
  - arm movement, 120
  - cat, 145–6
  - crossover positions, 117
  - cycles, 114, 121–8
  - dog, 141–5, 152–7
  - exercise, 132–3
  - external influences, 128
  - human, 113–29, 132–5
  - mechanics, 116–21
  - moods, 121–7
  - pace, 115–16
  - shoulder movement, 116, 118–19
  - stride positions, 116–17
  - two people together, 129
  - up and down body movement, 120–1
- Water splash, 36, 108
- Water-filled balloons, 33–5, 44–5
- Weight, 29, 57, 63–8, 141, 183
- Whiz lines, 101, 133
- Wings, 170–7
- Working practice, 1–27
- Wringing, 184
- Wrists, 120
- Writing character animations, 229
- X-sheets, 4–10, 21
- animation acting, 229
  - dive exercise, 106
  - double acting in 2D, 252
  - lip-sync, 265–8
  - sound tracks, 257
  - thumb-sheets, 61–2
- Xsheet window, 20–1
- Yaw, 162